

HAACK NET PRO

Our video instructions provide the best guidance for setting up your Haack Golf Net.
They can be viewed online at



Please call us if you have any questions or concerns at **1-855-4RUKKET**
Please read our product safety warnings before setup

WHAT'S INCLUDED

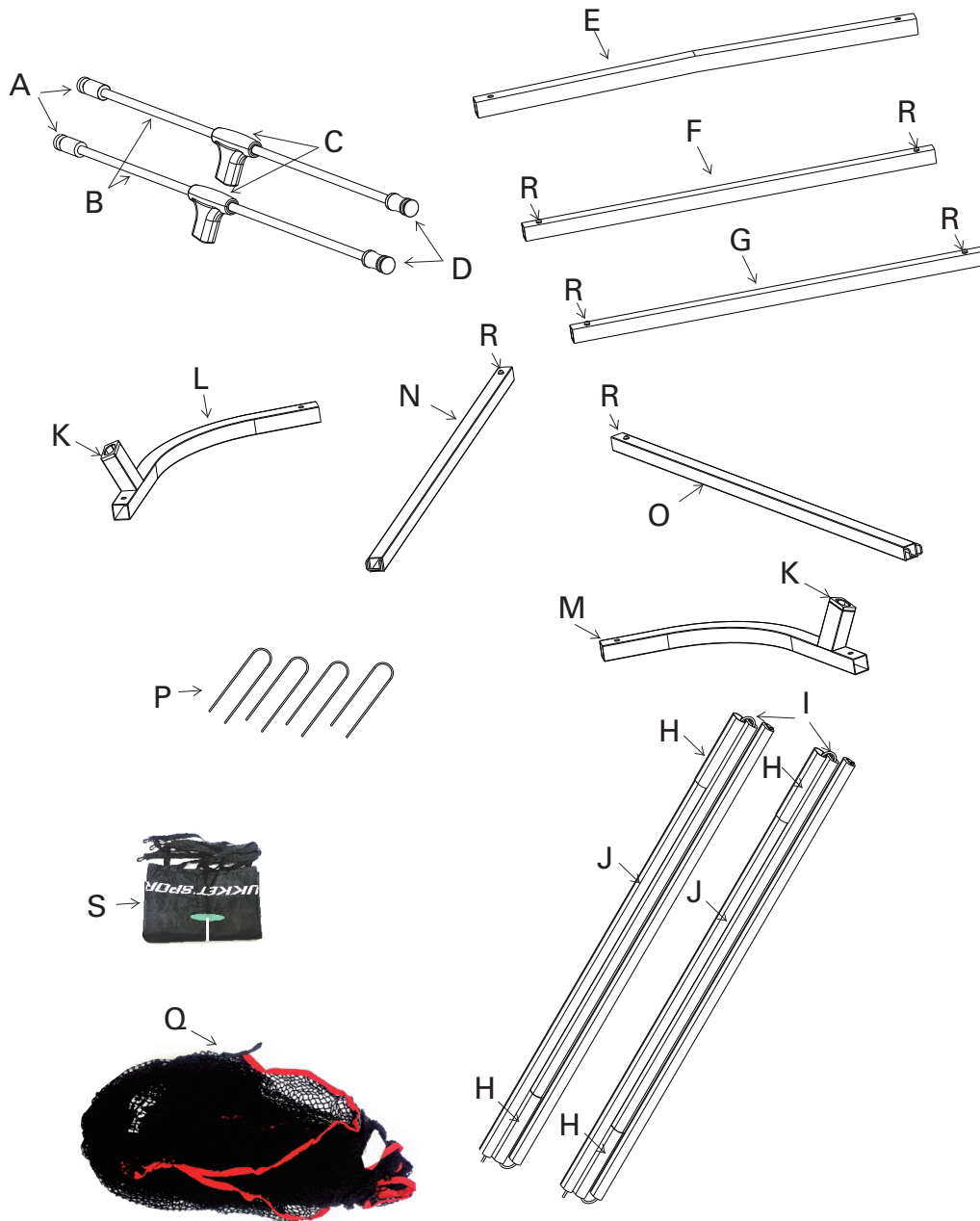

- A: Pipe plug behind fiber rod
- B: Fiberglass
- C: Three-way plastic parts
- D: Fiber rod front pipe plug
- E: Intermediate connecting tube
- F: Left connecting tube
- G: Right connecting tube
- H: Metal casing
- I: Rubber rope
- J: Flat fiber rod
- K: Flat fiber rod rubber tube plug
- L: Left elbow
- M: Right elbow
- N: Left forefoot tube
- O: Right forefoot tube
- P: Metal stakes
- Q: Golf net
- R: Spring button
- S: Target

QUESTIONS? GIVE US A CALL! (1-855)-478-5538



HAACK NET PRO

ASSEMBLY INSTRUCTIONS



Product Safety Warning

- Please use adult supervision and follow the instructions when setting up and using the net.
- Regular use or abuse will eventually strain the netting and may break it, as well as extended exposure to outdoor elements will effect the lifetime of the net.
- Do not stand behind the net.
- This net is not intended for personal protection.

Prior to each use

- Inspect the netting and frame for damage or wear. If damage or wear is found, do not use net until new netting can be used so the balls do not break through the net. Replacement nets can be purchased at Rukket.com
- Make sure the frame and net are assembled correctly and on a flat surface, at least ten (10) feet from structures and vehicles.
- The user should be positioned directly in front of the net(at least 10-12 feet to avoid injury of ball rebound).
- Failure to follow these precautions could result in serious injury or damage to property.

1. Assemble the base.

Note: The buttons and holes for the rear pieces are all on the top of the pipes, while the buttons and holes for the legs are on the sides facing inward.

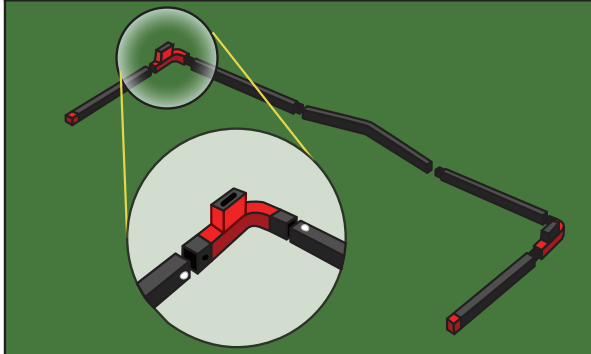

2. Lay out the net so that the four sleeves are on top of the net and the net's black border is near the base frame. The "Rukket Sports" and "Rukket.com" logos will be facing outward when your net is fully assembled.

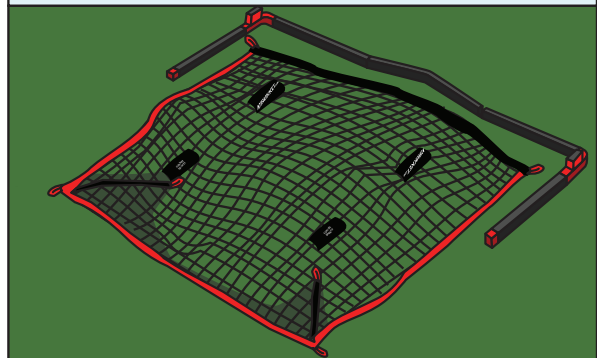

3. Assemble the fiberglass poles.

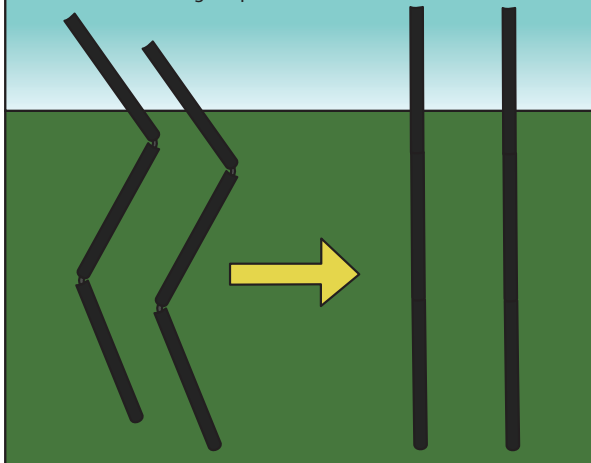

4. Run both fiberglass poles through the sleeves.

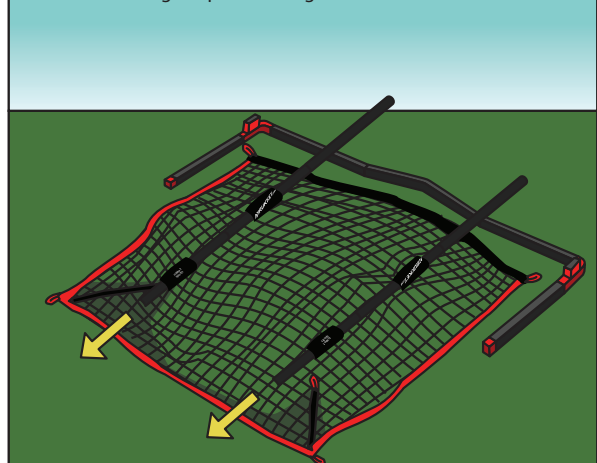

QUESTIONS? GIVE US A CALL! (1-855)-478-5538



HAACK NET PRO

ASSEMBLY INSTRUCTIONS

5. Lift one of the fiberglass poles upright and insert the end closest to the base into the receiving post in the base. Repeat on the other side.

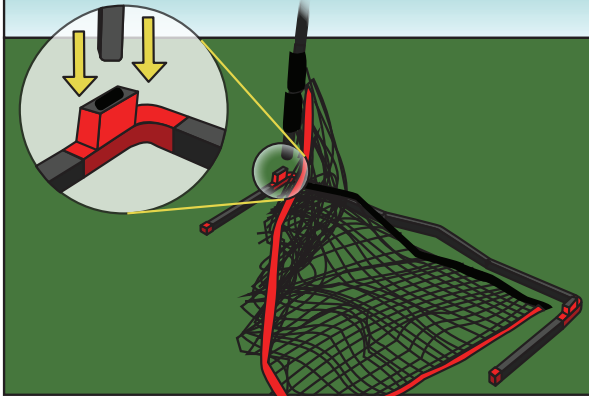

6. Attach the upper side arms to the tops of the fiberglass poles with the red knob pointing forward. You can bend the fiberglass pole down to the left or right if the top is too high to reach.

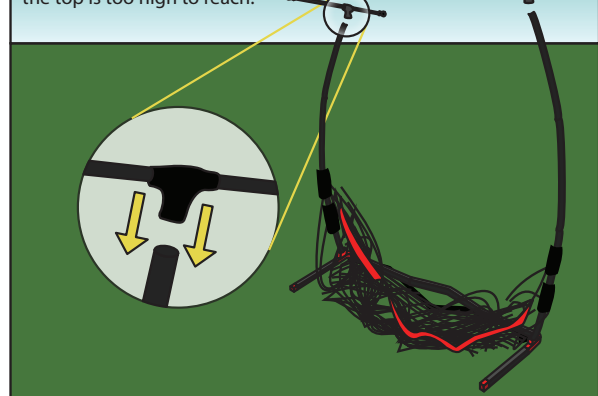

7. Hang the net by looping the top-front red loops over the red knobs on the fronts of the side arms. Loop the front-bottom loops over the red hooks at the ends of the frame legs.

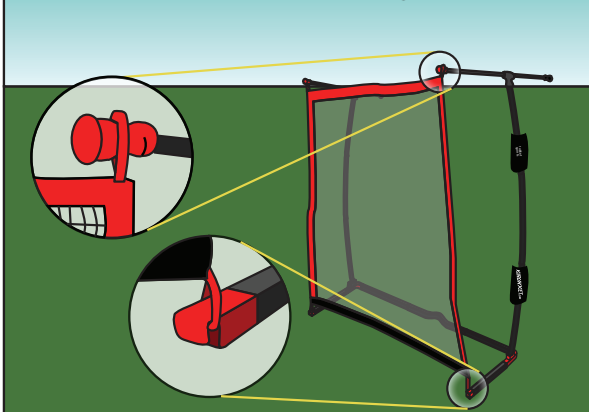

8. Attach the two upper-rear red loops to the black knobs on the backs of the side arms.

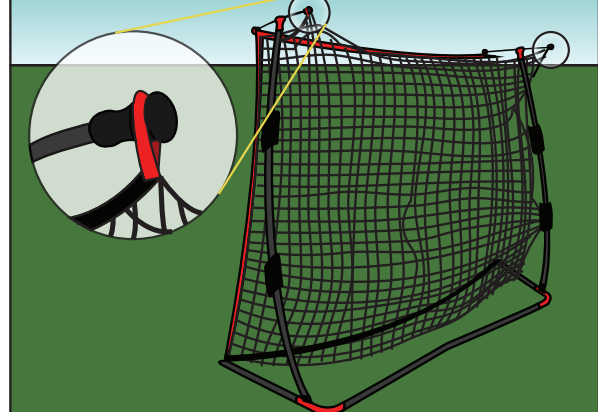

9. Attach all 4 clips of the target to the red loops on all four corners of the frame of the net. Slide buckles on target to add slack to target. Target should not be tight.

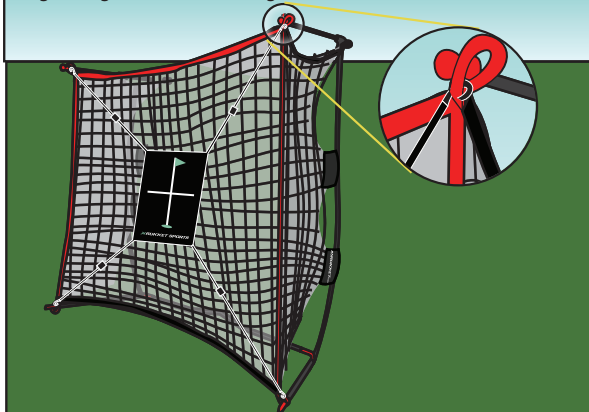

To contact us or for warranty information, please go to:

<https://rukket.com/pages/contact-us>

Replacement Nets can be found at Rukket.com

QUESTIONS? GIVE US A CALL! (1-855)-478-5538

RUKKET
SPORTS