

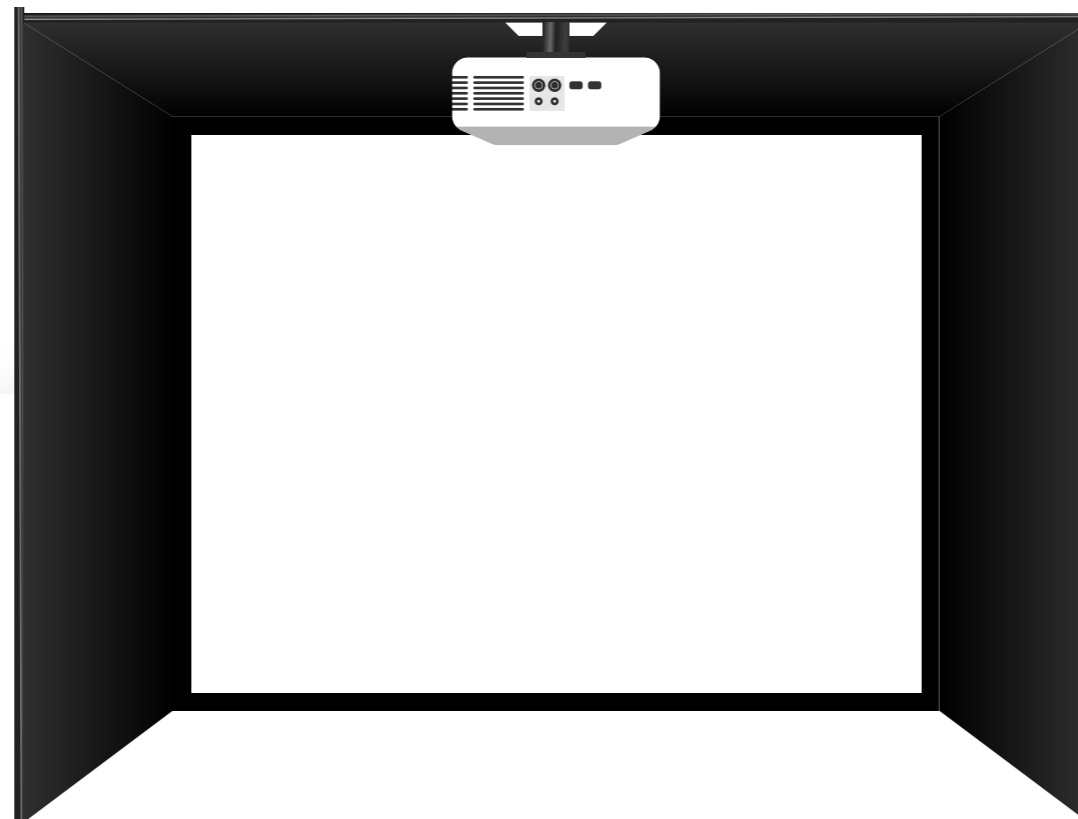

# Golf Simulator Par 3 Enclosure

ASSEMBLY INSTRUCTIONS

**3m x 2.6m x 1.6m / 10' (W) x 8'6" (H) x 5'4" (D)**



# Packaging

Your Golf Simulator Enclosure will come in 2 separate cartons:

1 x long carton - metal frame

1 x rectangular carton - enclosure material with screen

💡 It's best to build the enclosure with two people

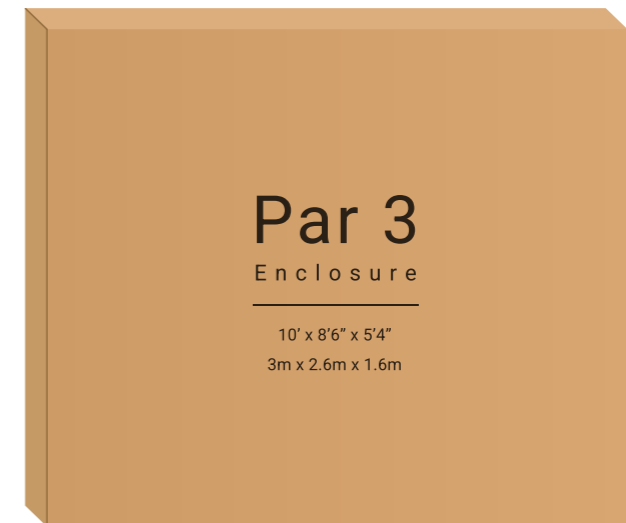
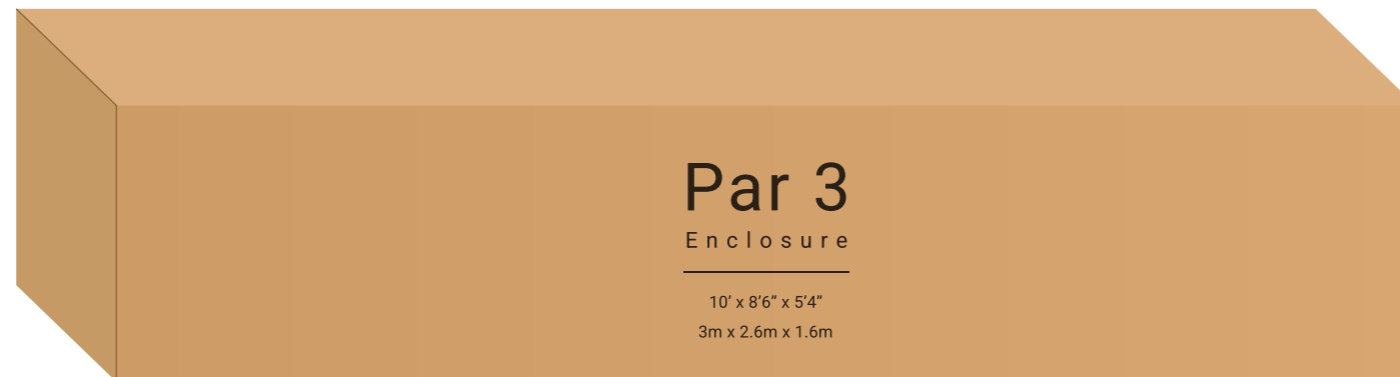

# Long carton contents

**A**



Male

11 x 3.3ft (1m) pole

Female

**B**



Male

11 x 3.3ft (1m) pole

Male

**C**



Male

5 x 2ft (0.6m) pole

Female

**D**



Male

4 x 1.8ft (0.55m) pole

Female

**F**



Male

1 x 3.3ft (1m) pole

Hole



Male

HDMI cable

Hole

# Long carton contents

1

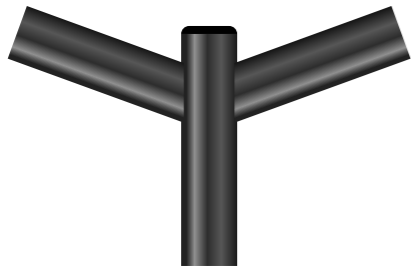

2 x 105° 3-way connector

2

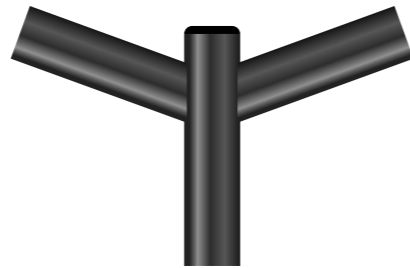

2 x 105° 3-way connector

4



2 x 2-way feet connector

5



2 x 3-way feet connector

X



2 x crossover clamp

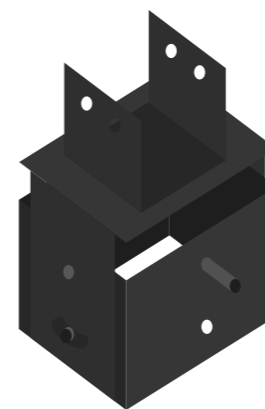

1 x Mounting Bracket

# Rectangular carton contents

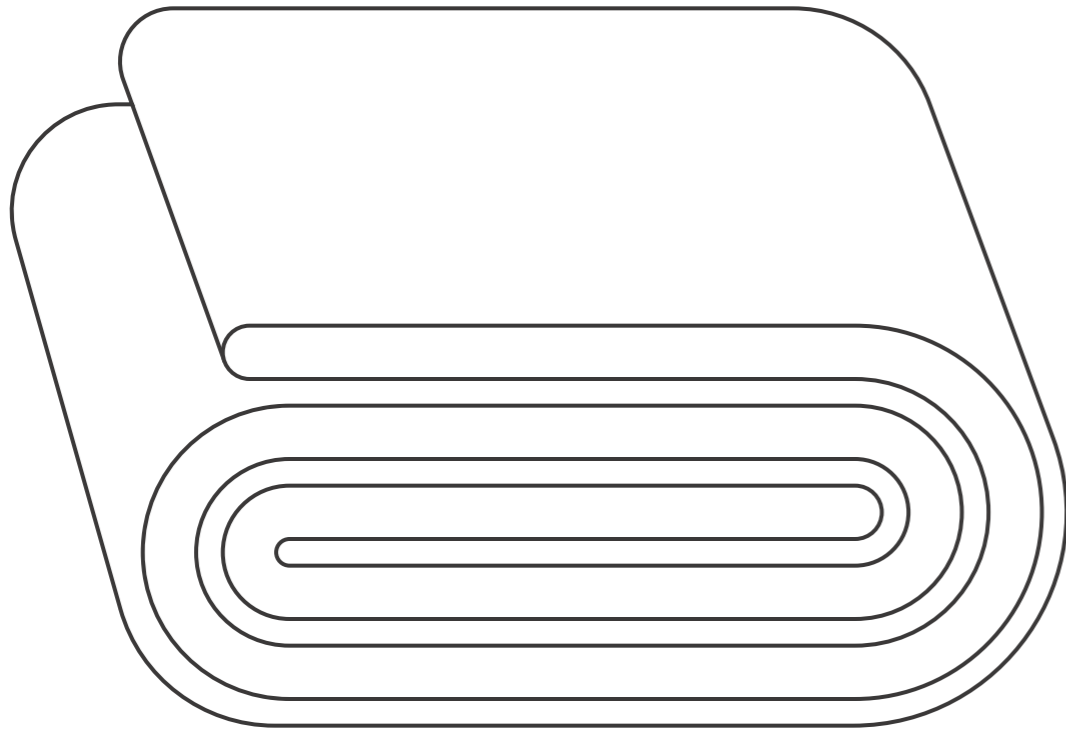

1 x Enclosure material with Screen.

It is a single piece construction containing the projector screen, side and ceiling panels

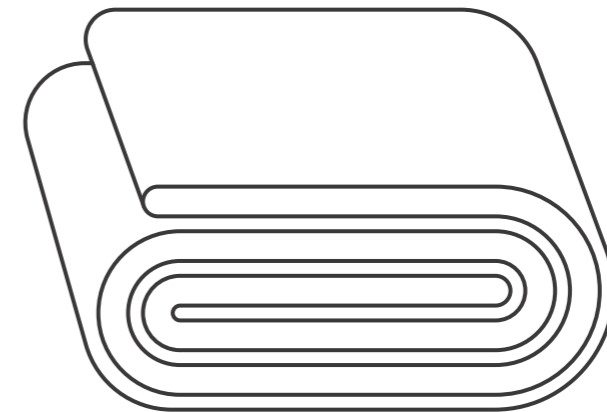

1 x Replacement Hitting Screen (attached on inside of Enclosure Material with Velcro)



9 x Clip

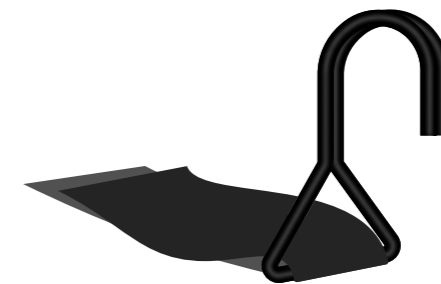

2 x Clip with Velcro

These are used to secure the bottom of the screen inside the enclosure

# Poles

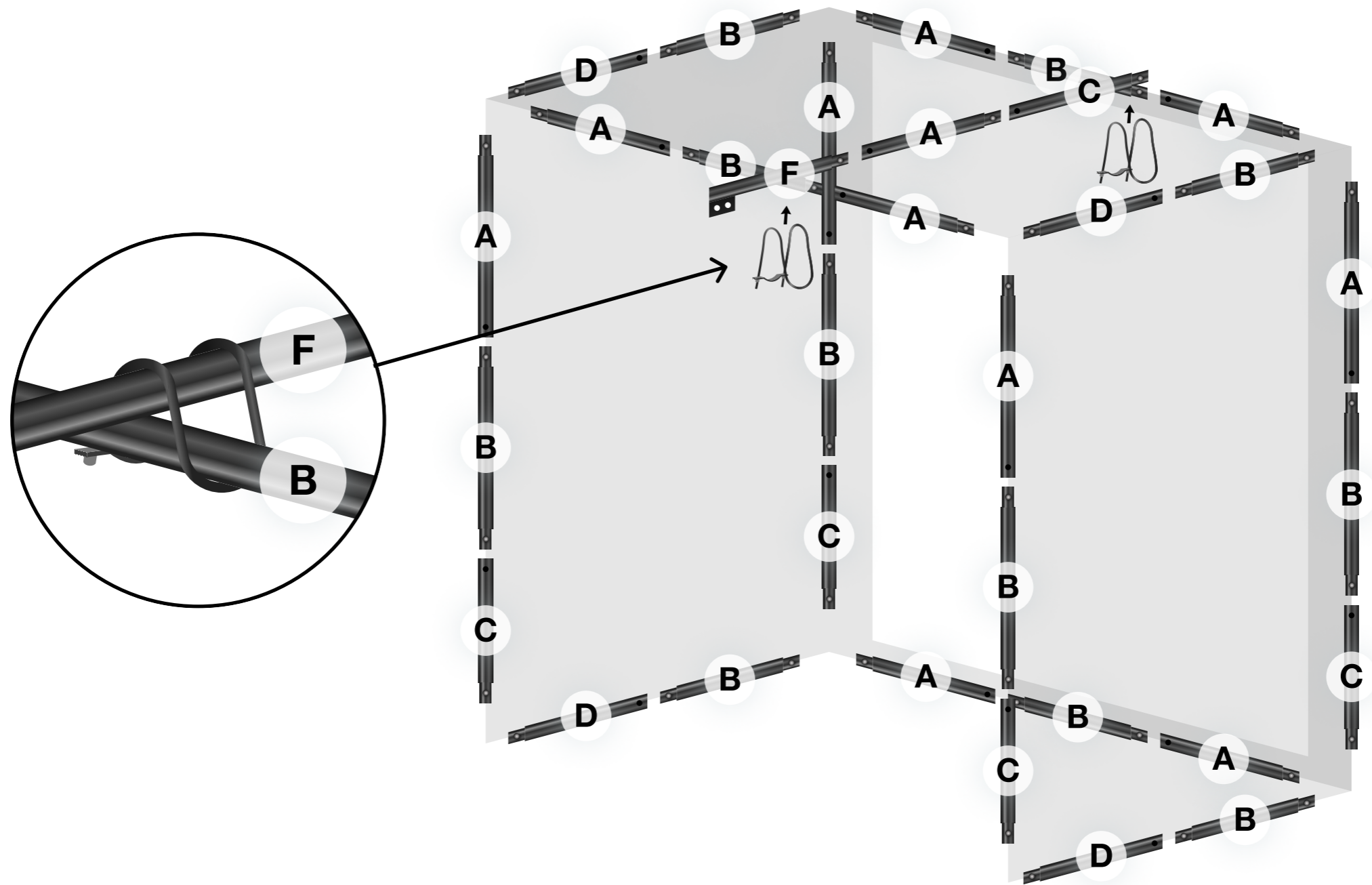

# Connectors

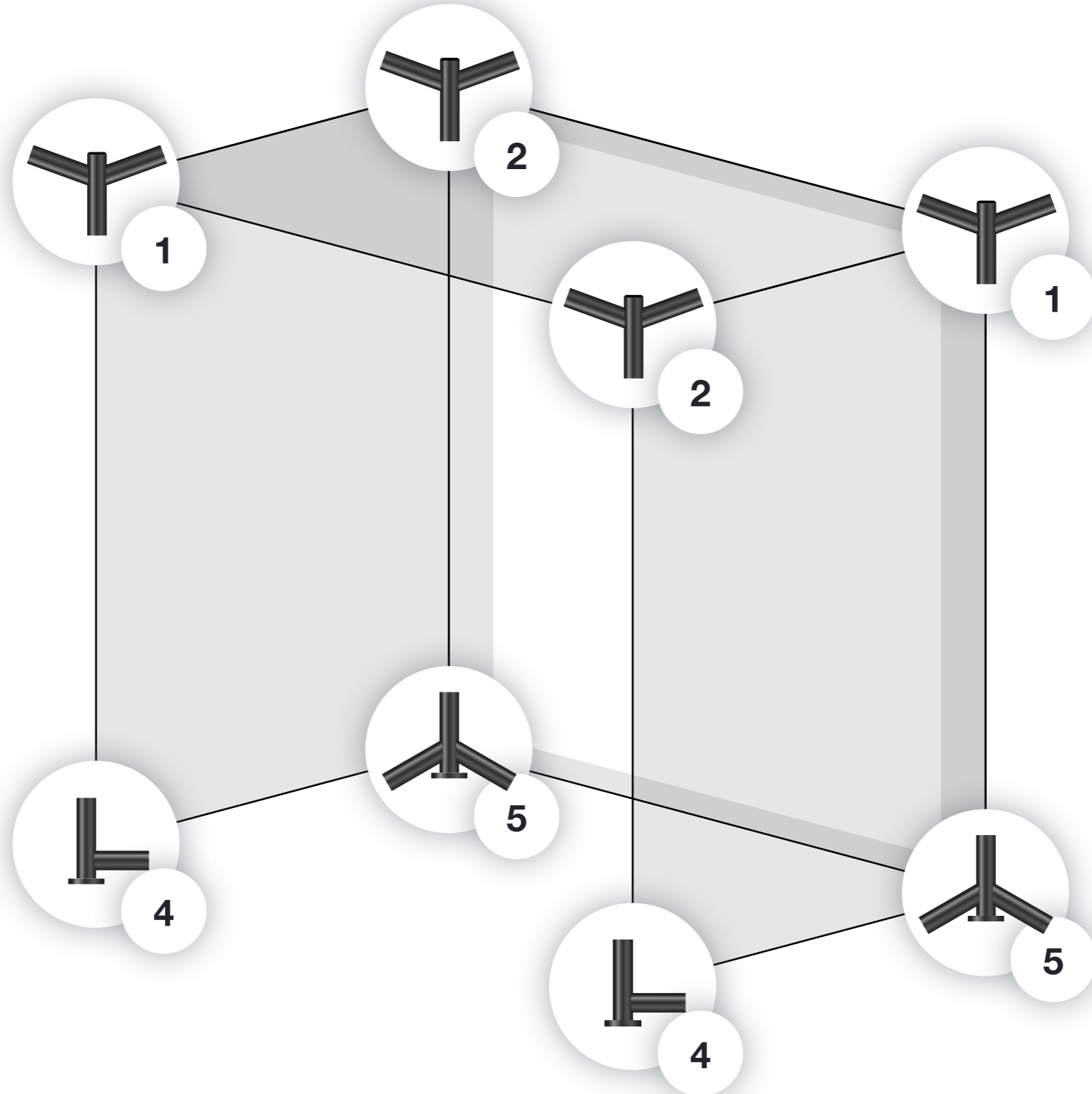

# Step 1

Lay out corners on the ground as displayed, with 10 degrees facing in towards each other on the front and back bars of the enclosure.

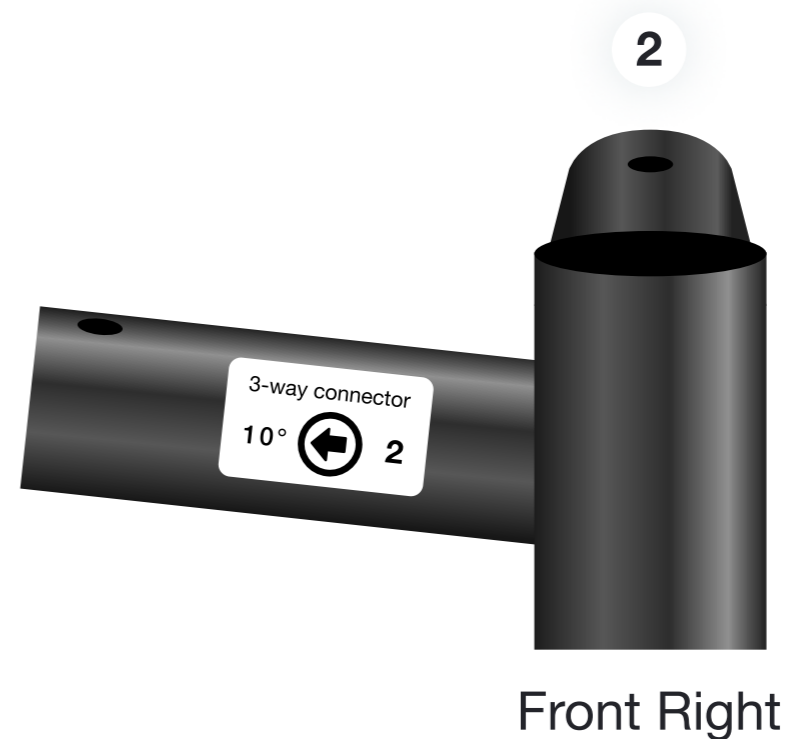
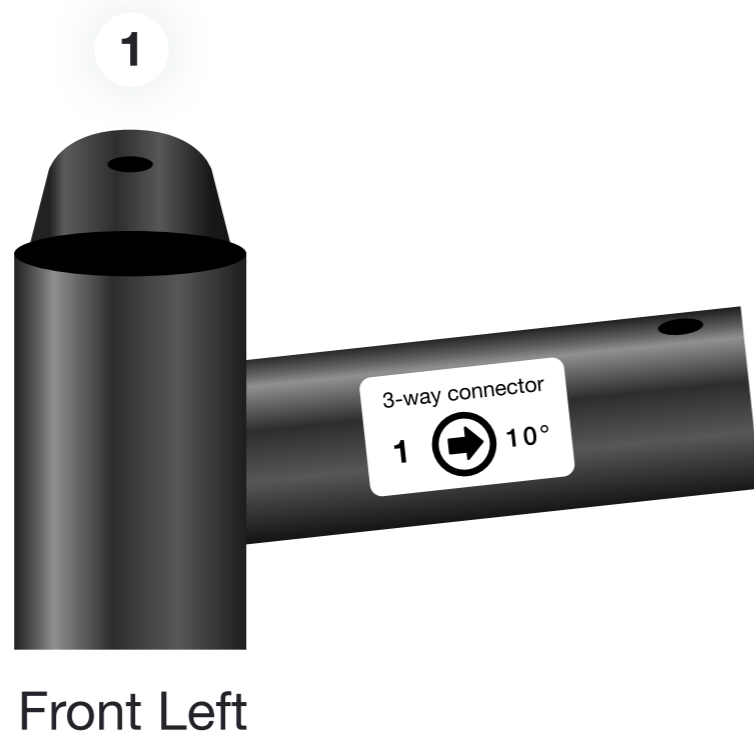
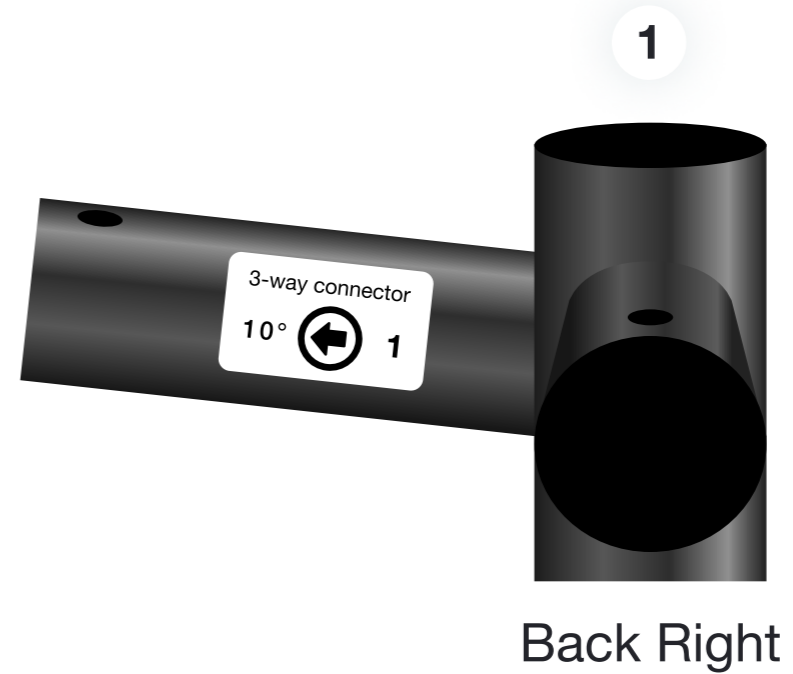
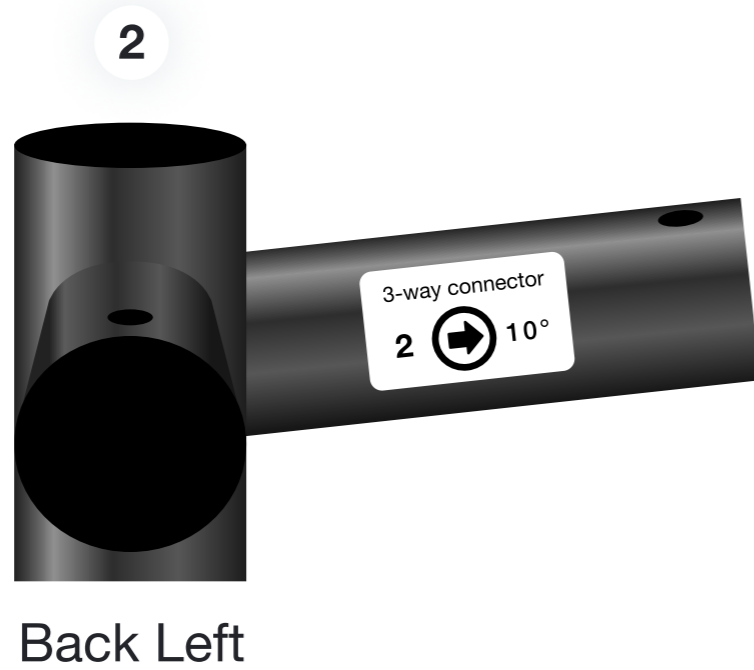



# Step 1.1

Assemble the upper frame by connecting the poles as shown on Figure 1

Keep the frame at 1m height to enable affixing the enclosure canopy material to the roof.

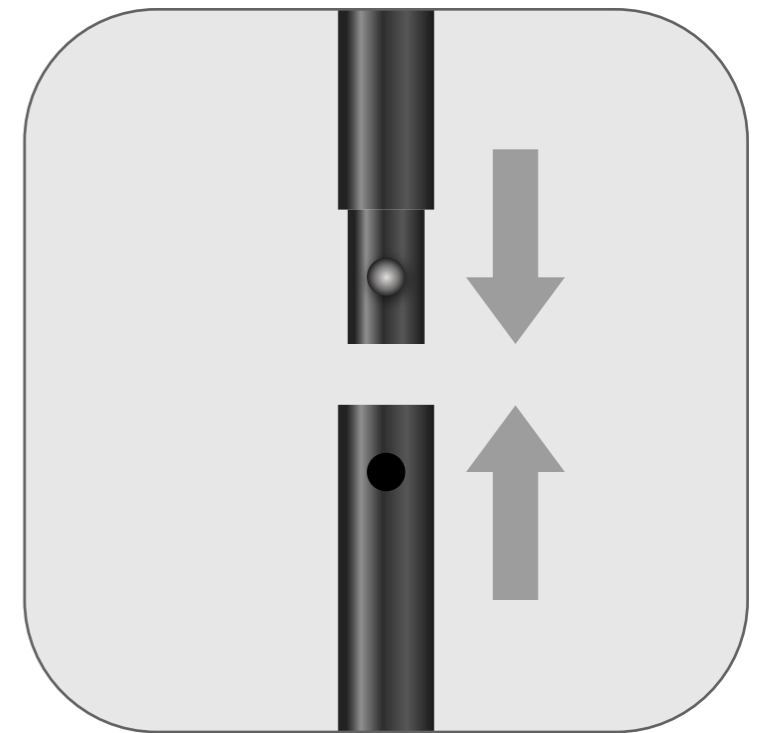
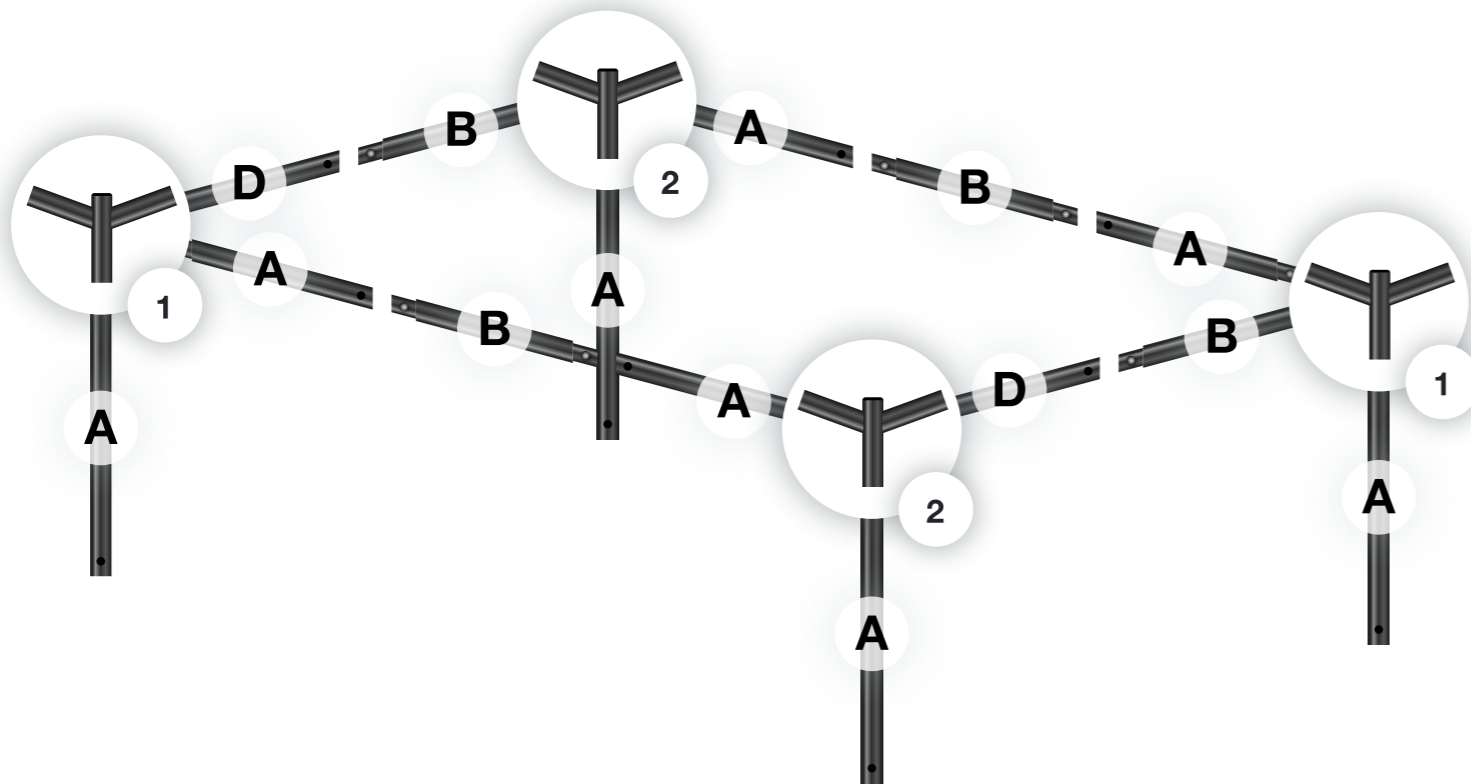
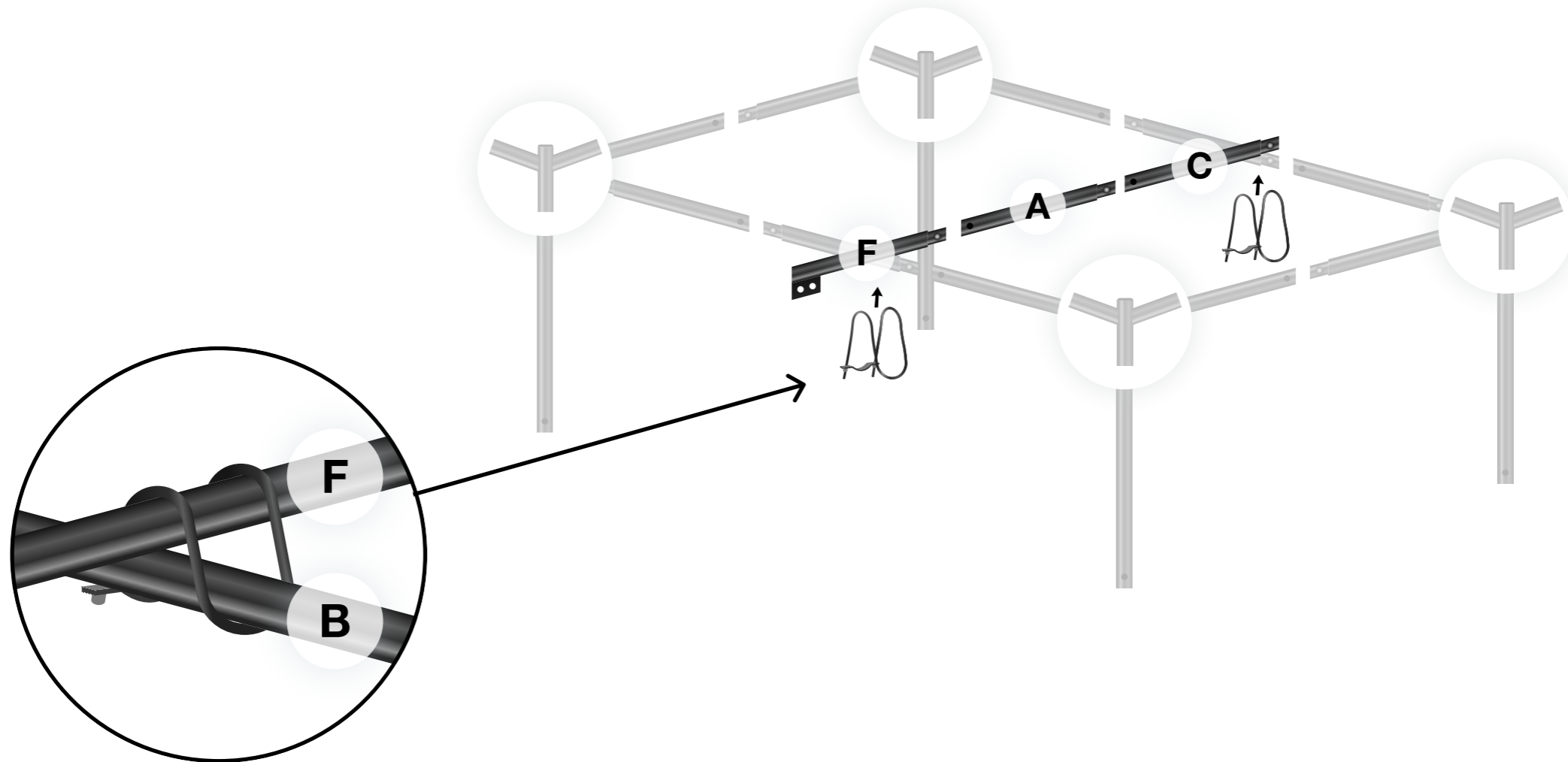

Figure 1

# Step 2

Attach projector mounts to the upper frame



## Step 3.1

Place the material in the centre of your enclosure area and spread the black material out so that you can identify the bottom of the screen.

The front of your hitting screen (where you hit the ball into) is the smooth side.

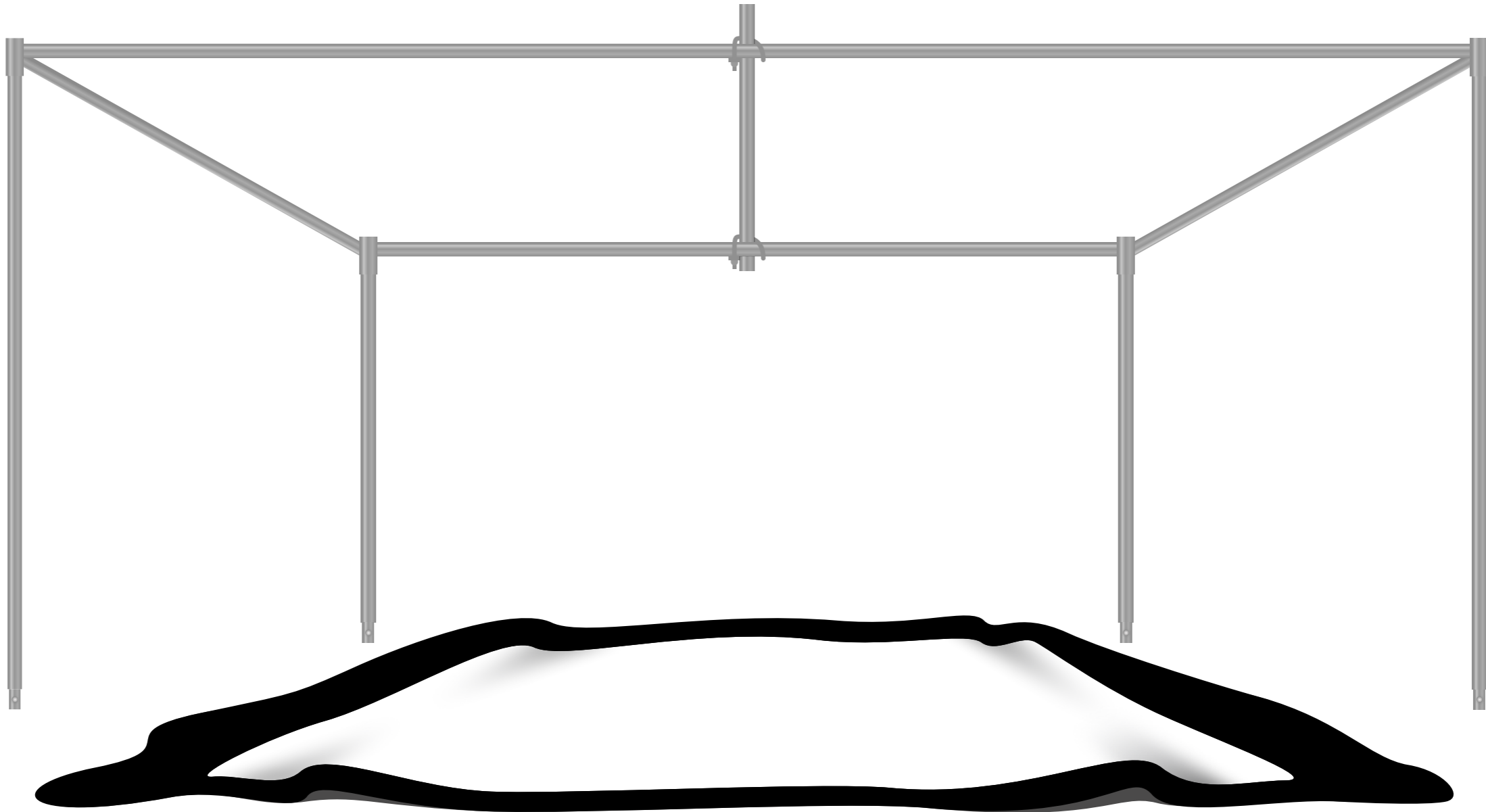

## Step 3.2

Secure all 4 top edges of the enclosure material to the upper frame using the Velcro attachments as shown on Figure 2

Affix the rear ceiling followed by the front ceiling

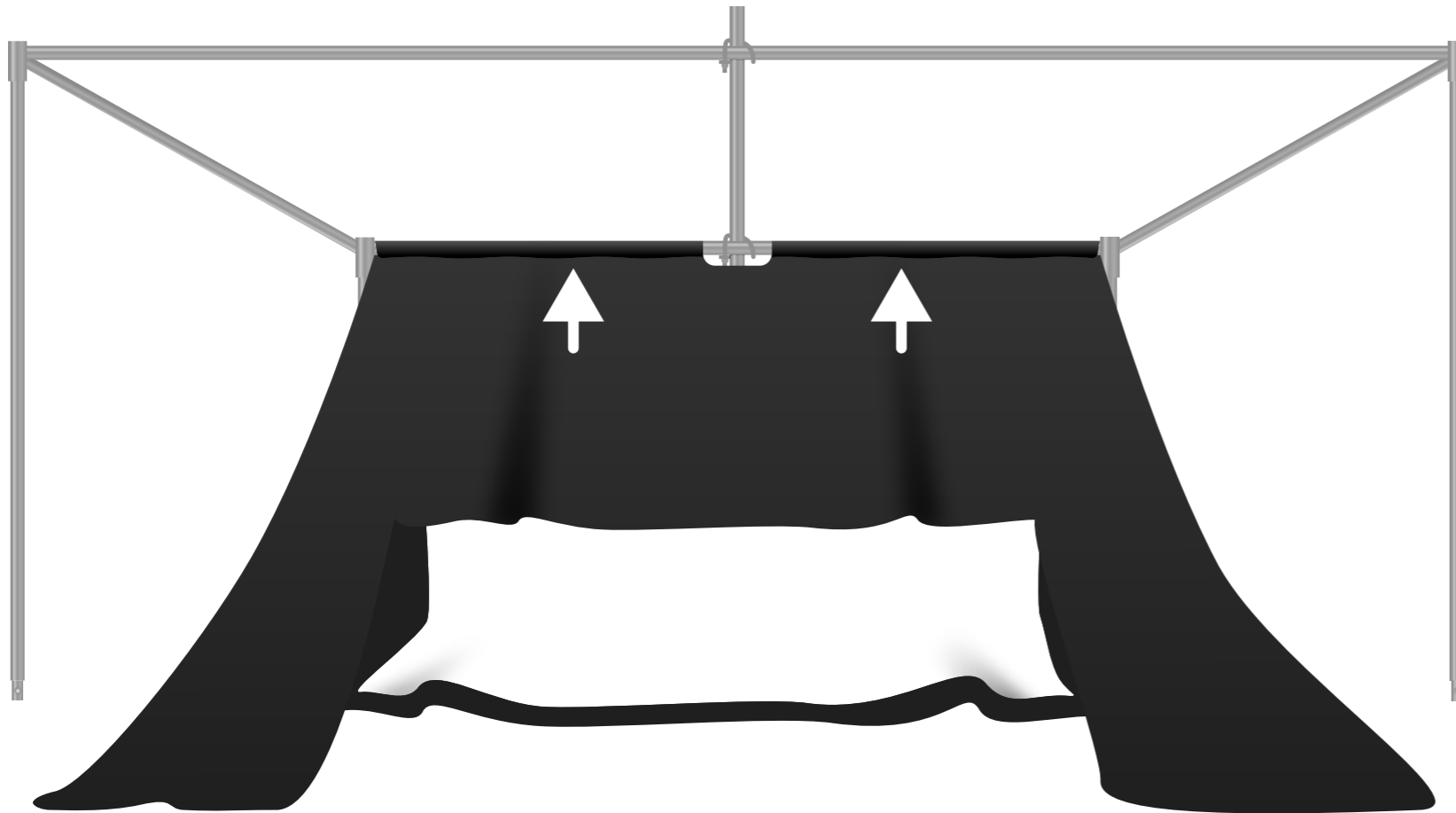

Figure 2

## Step 3.3

Secure material to the projector pole using the Velcro attachments as shown on Figure 2

💡 Leaving off the last 1/4 of velcro on the projector pole will allow you to velcro the impact screen on the inside of the enclosure

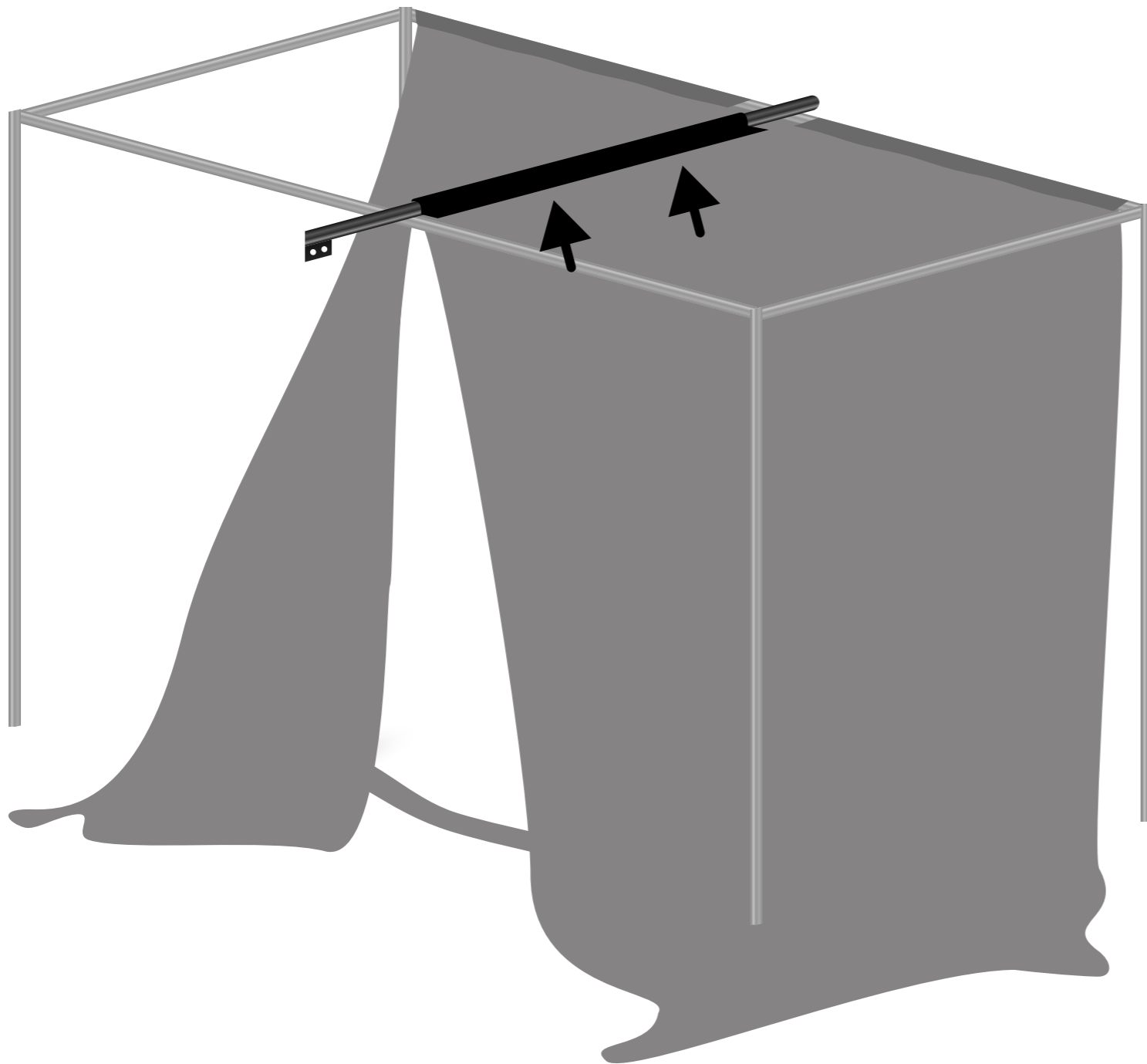

Figure 2

## Step 3.4

Secure material to the upper front frame using the Velcro attachments as shown on Figure 2

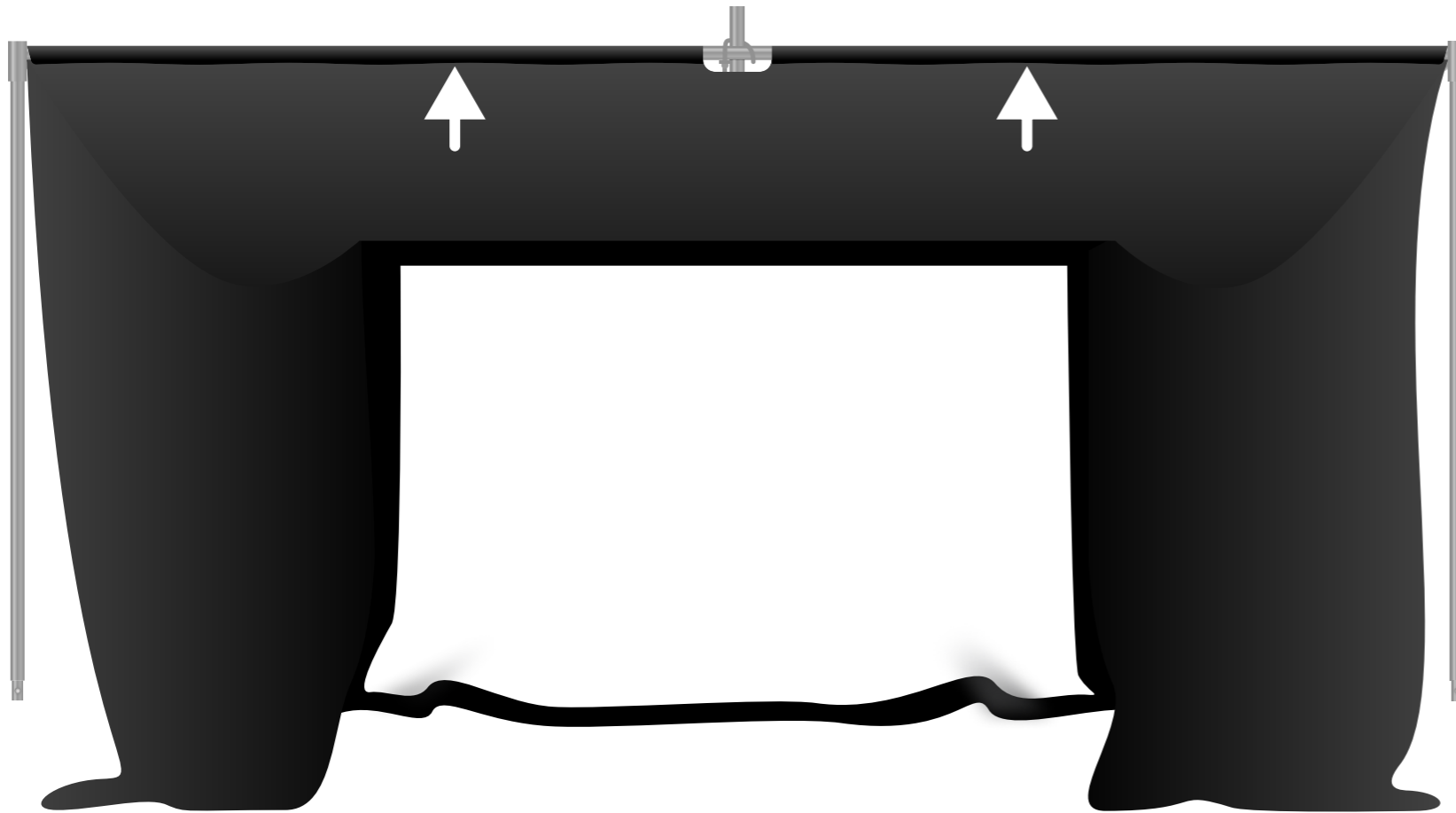

Figure 2

## Step 3.5

Secure material to the upper left frame using the Velcro attachments as shown on Figure 2

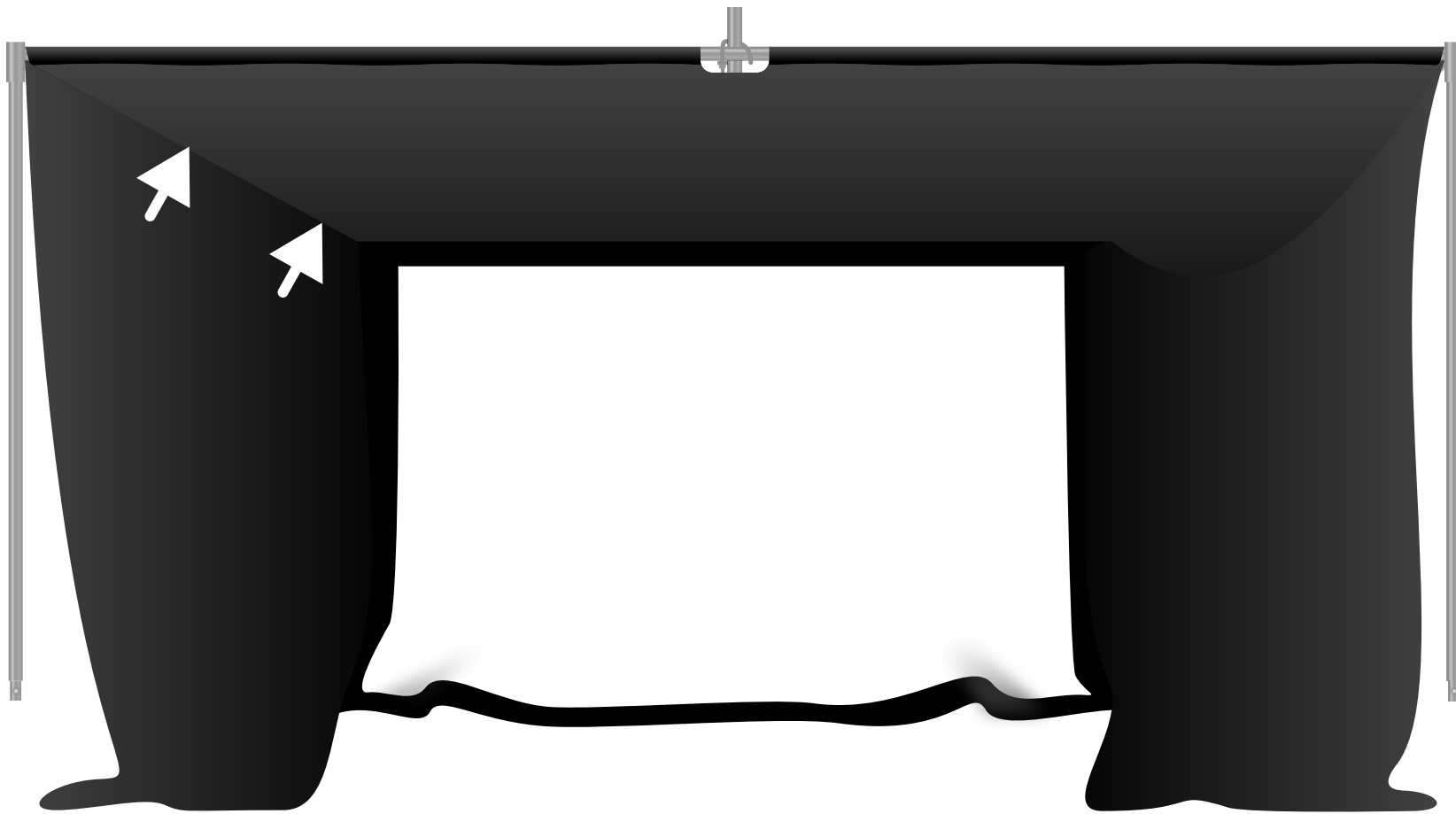



Figure 2

## Step 3.6

Secure material to the upper right frame using the Velcro attachments as shown on Figure 2

 This step of securing the velcro on the sides of the ceiling requires 2-3 people, and completely secure one side first before starting the otherside. You will need to pull the fabric tight by grabbing it from the underside and twisting it over the top. See Figure 3

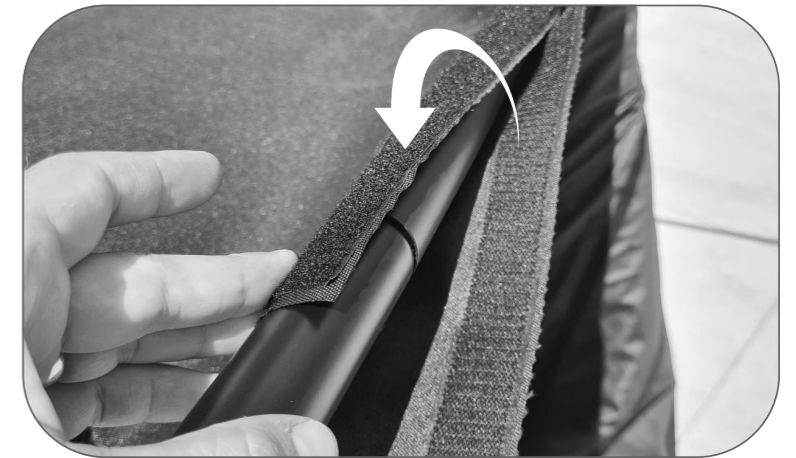
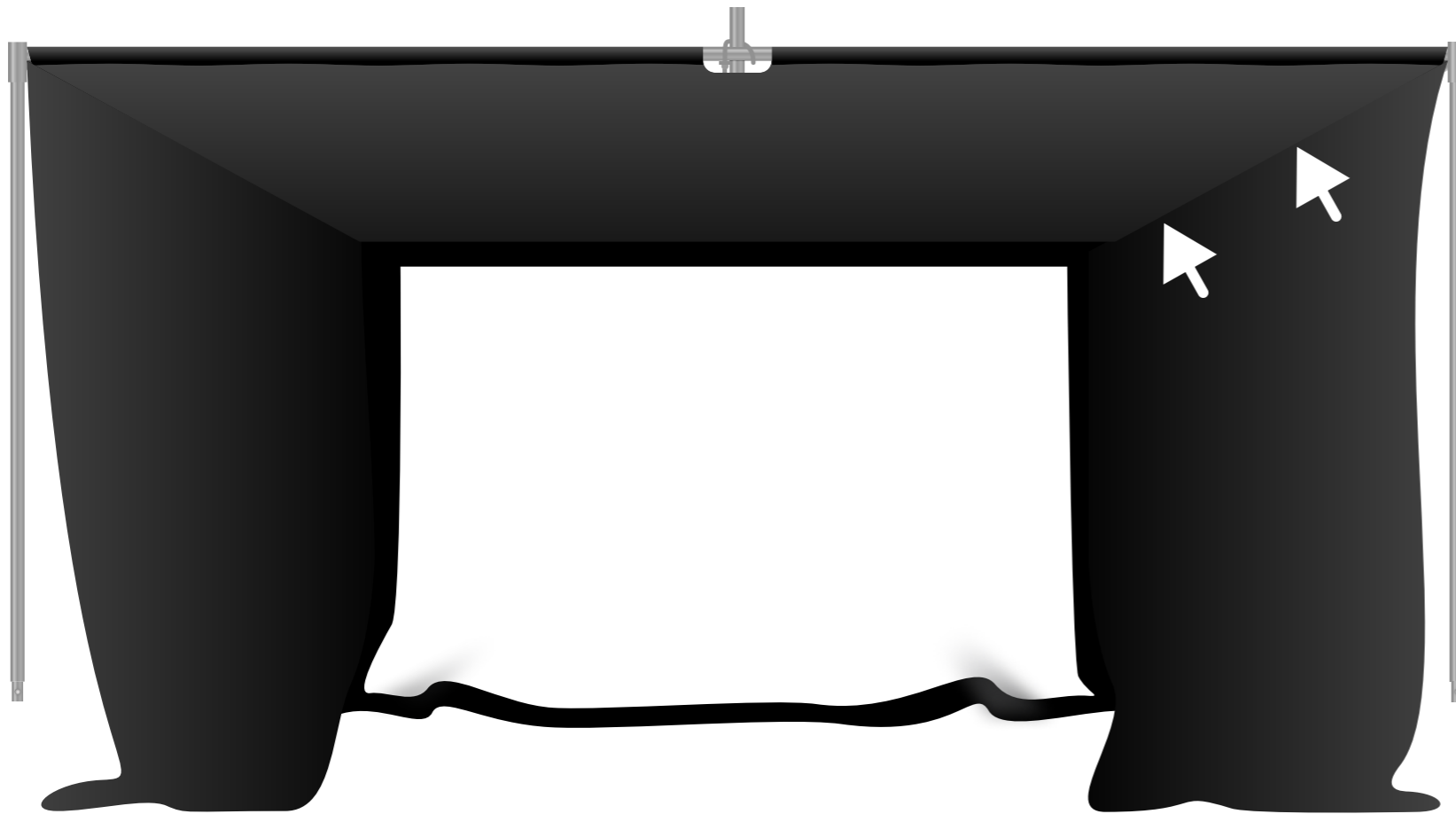

Figure 2

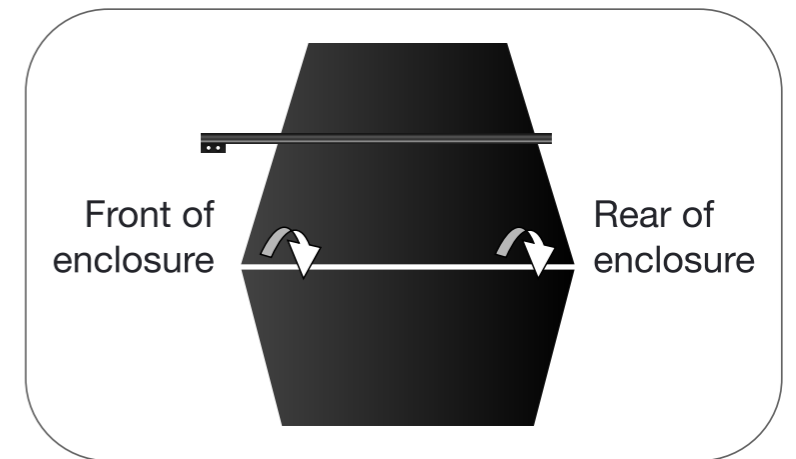

Figure 3

If the ceiling Velcro struggles to meet, pull firmly and twist from top to bottom in the motion shown. You will then be able to bring the Velcro up easier.



## Step 3.7

Attach the separate Impact Screen to the inside Velcro of the enclosure.

Start joining the screen to the Velcro here and run your hand along the ceiling join, attaching the Velcro as you go

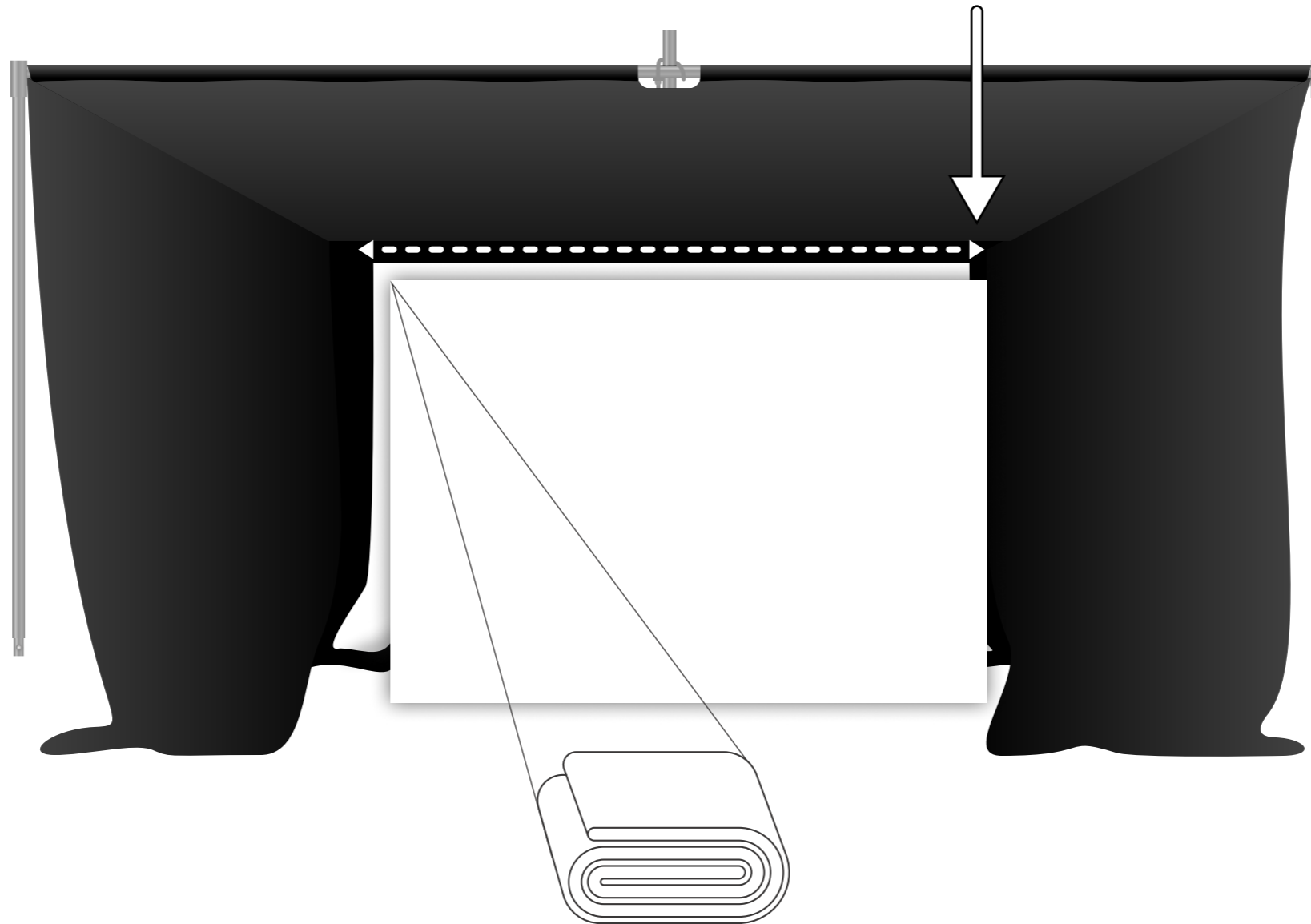

1 x Replacement Hitting Screen (attached on inside of Enclosure Material with Velcro)

## Step 3.8

To attach the impact screen, follow these steps:

- Two people should attach the top Velcro of the screen to the inside ceiling of the enclosure.
- Once attached, one person should move to the exterior side wall and push the seam inward towards the impact screen.
- To do this, start joining the screen to the Velcro (see arrow below) and simultaneously run your hands down, pushing towards each other and joining the Velcro as you go
- It's recommended to leave the Velcro on the back vertical poles undone, this will allow Velcro hook on the impact screen to meet the loop on the seam of inside the enclosure.

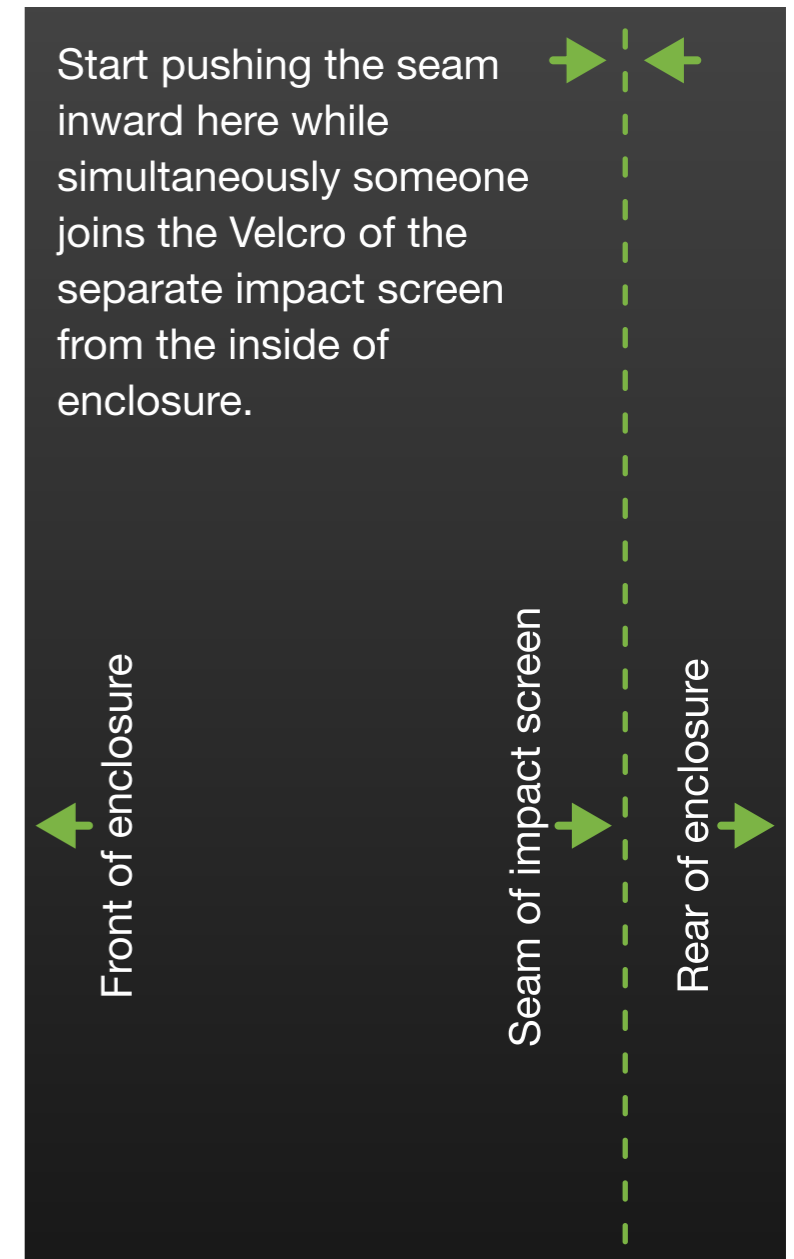
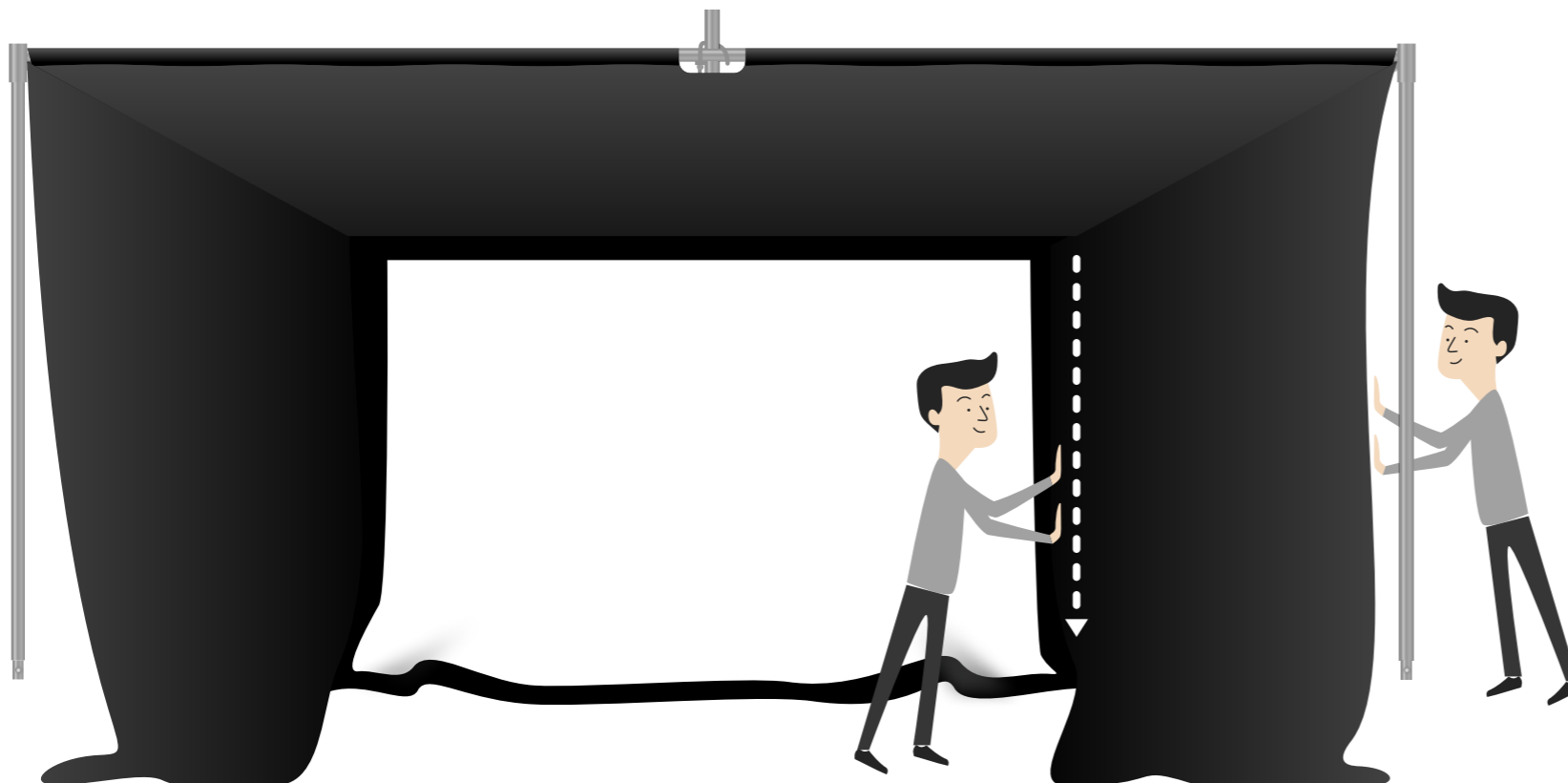

Side profile of the enclosure

# Step 4

Once the top is secured, attach the enclosure to each of the vertical upright legs as shown on Figure 1

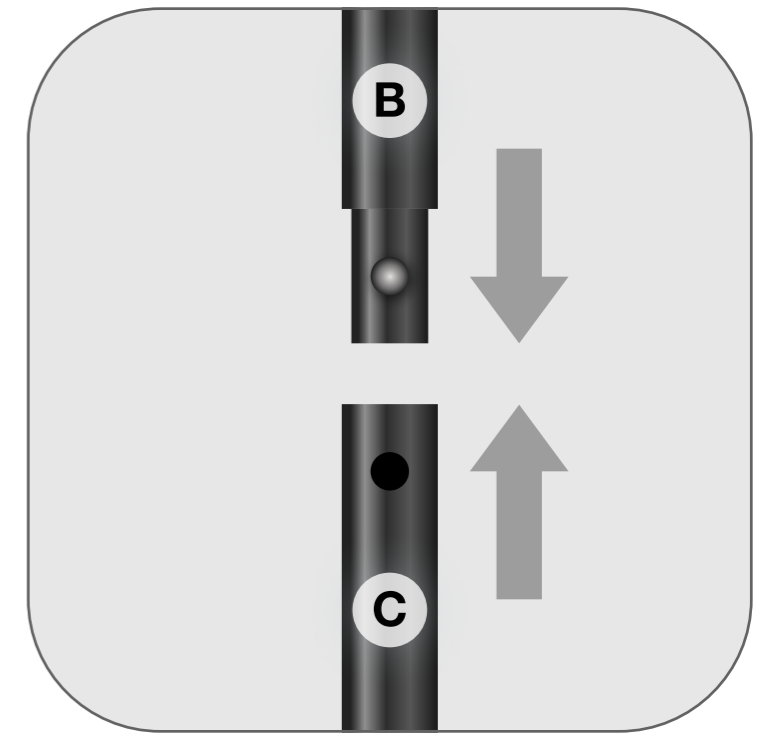
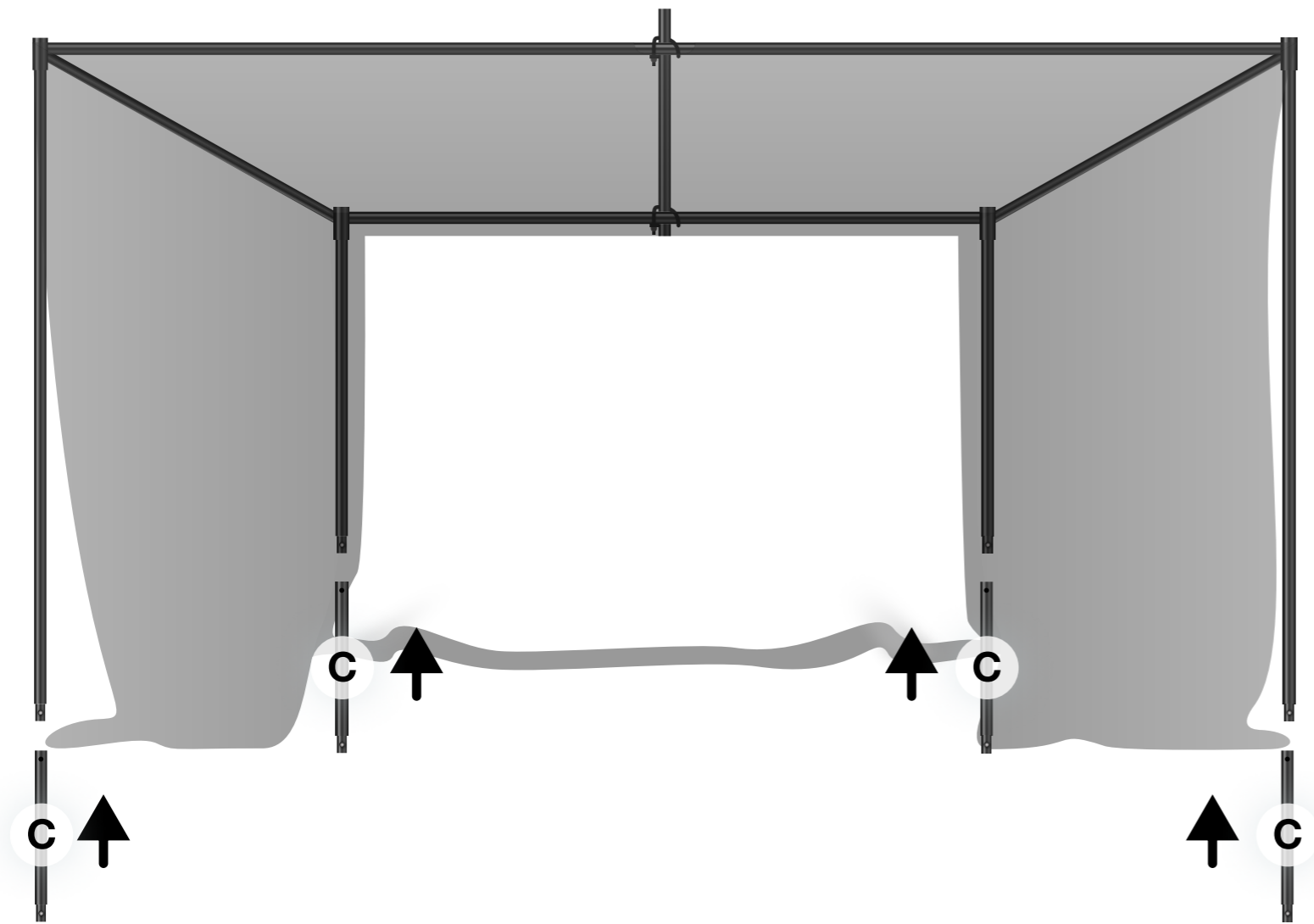

Figure 1

## Step 5

Assemble the lower frame as shown on Figure 4

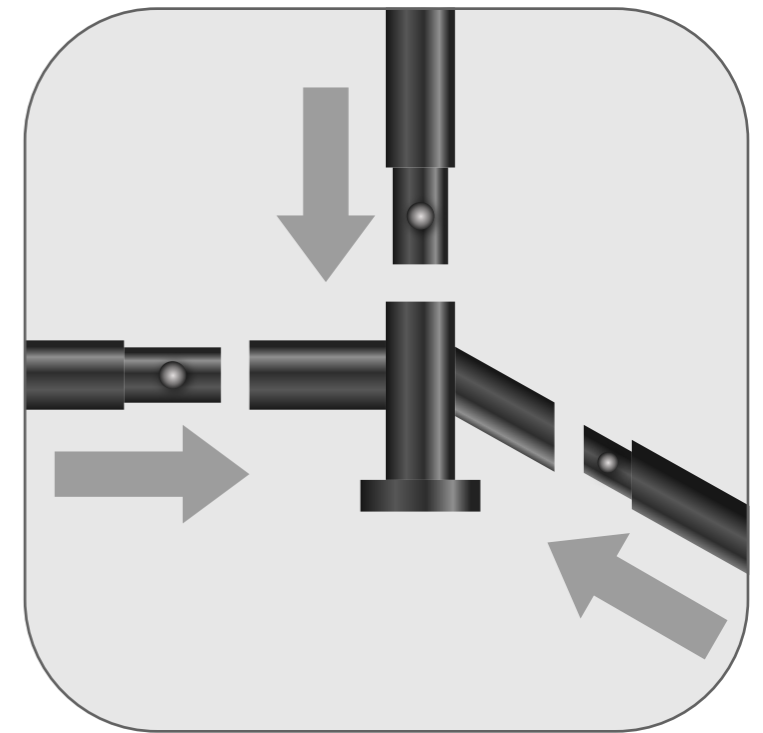
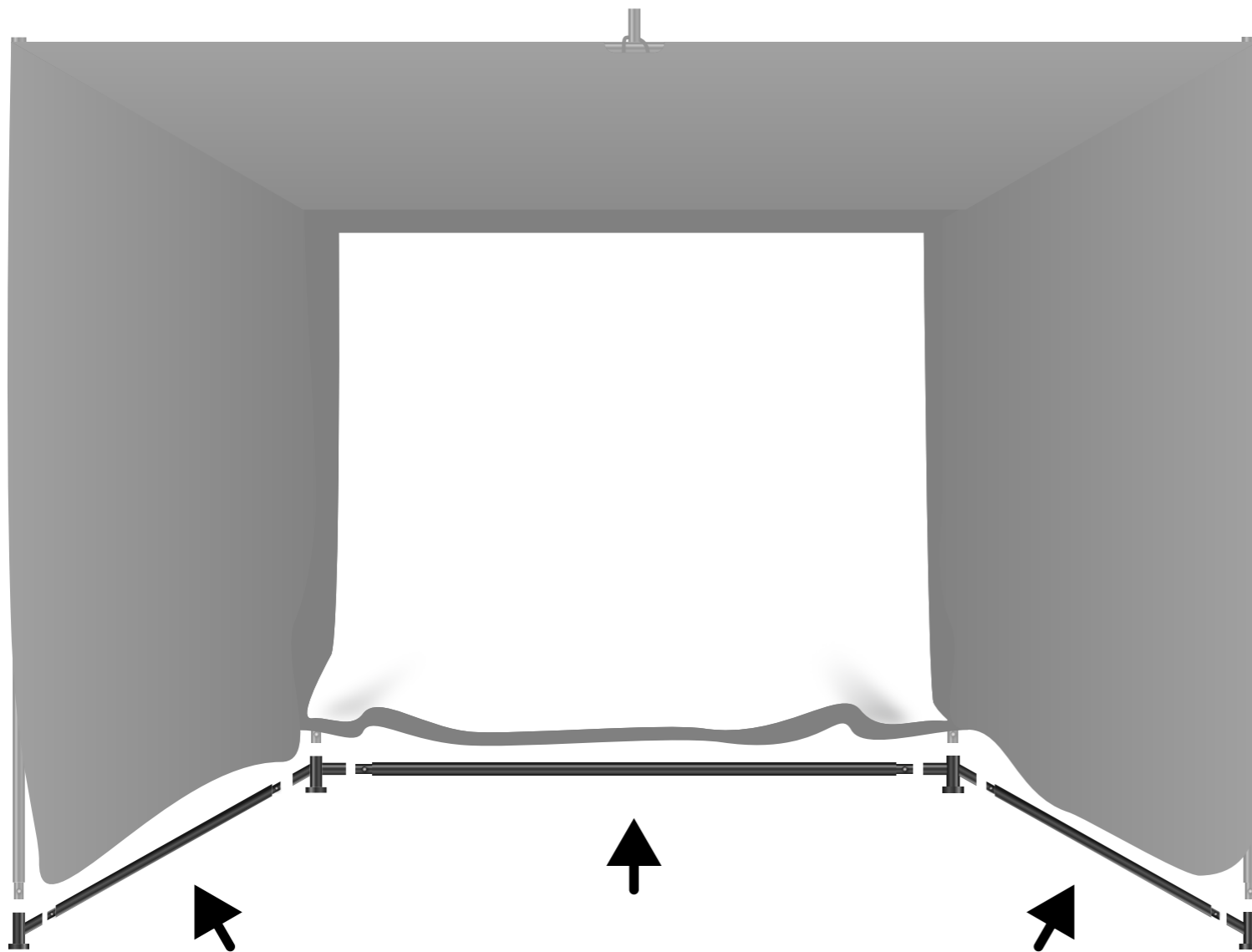

Figure 4

## Step 6

Wrap and secure the remaining perimeter edges to the frame using the Velcro attachments as shown on Figure 5

💡 Please note - On the rear exterior at the bottom you may find this particular position will never meet. Rest assured this area will not jeopardize the integrity of the enclosure - provided the majority of the strip is joined.

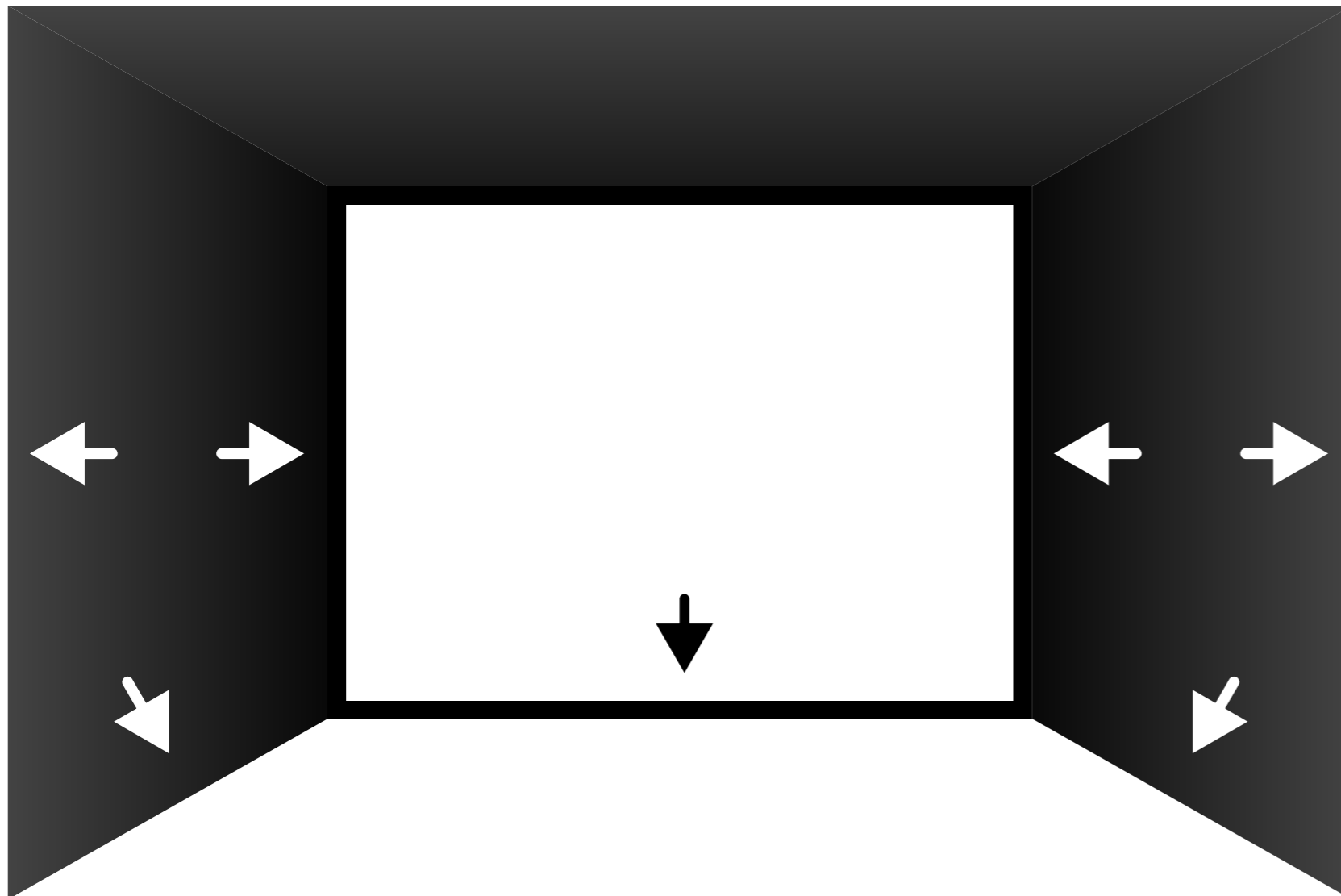
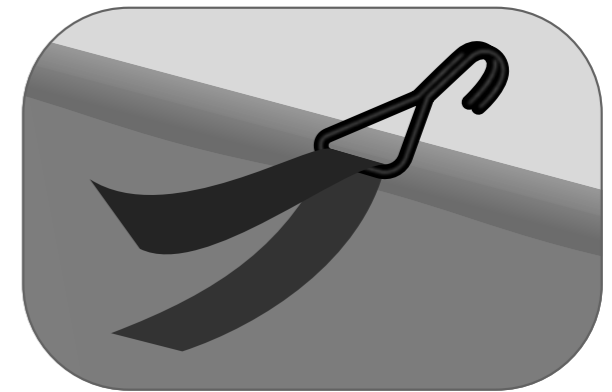
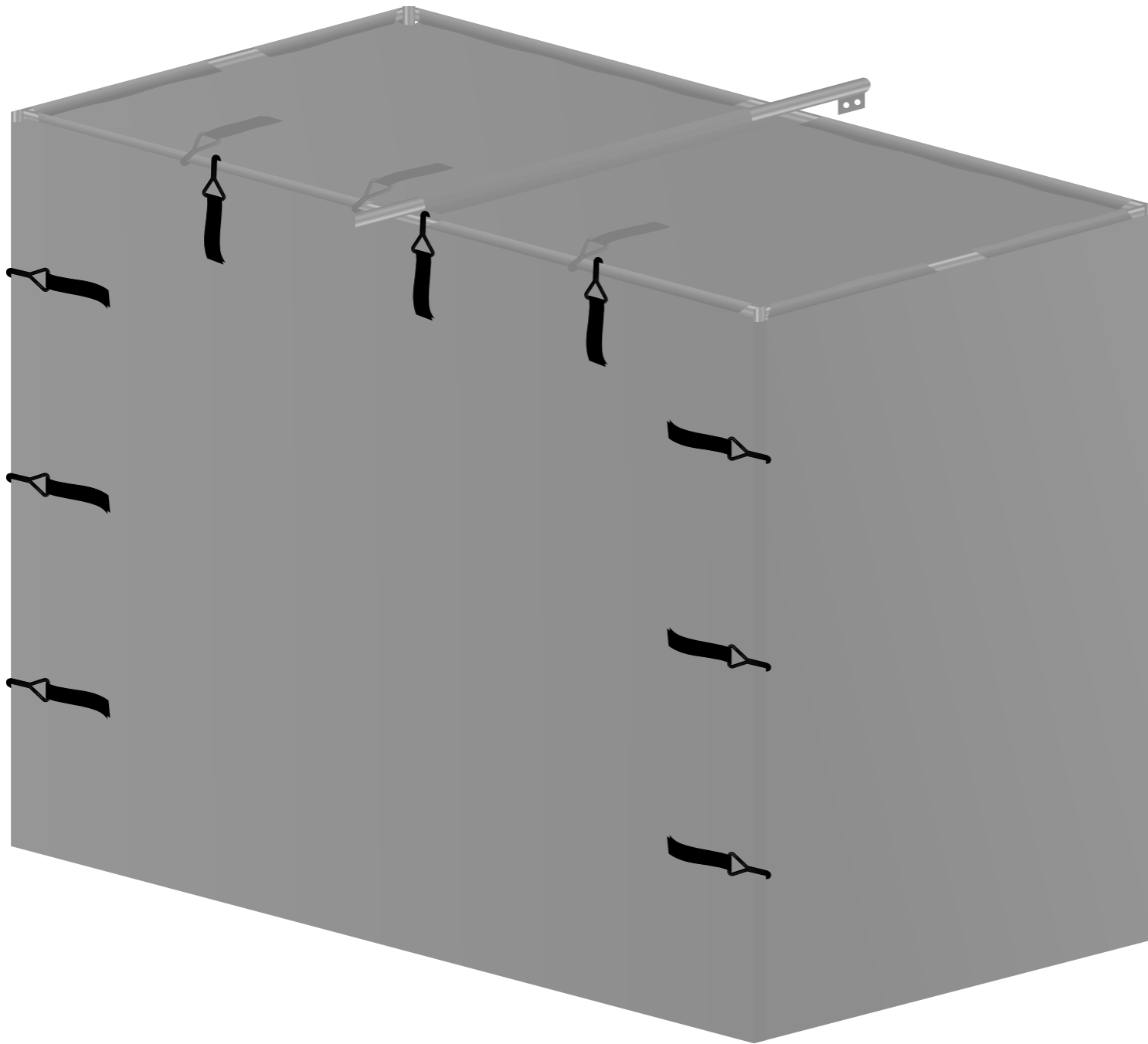

Figure 5

## Step 7

If your screen needs tightening, use the hook and velcro straps on the backside of the enclosure to pull screen tight



Attach clip to Velcro.

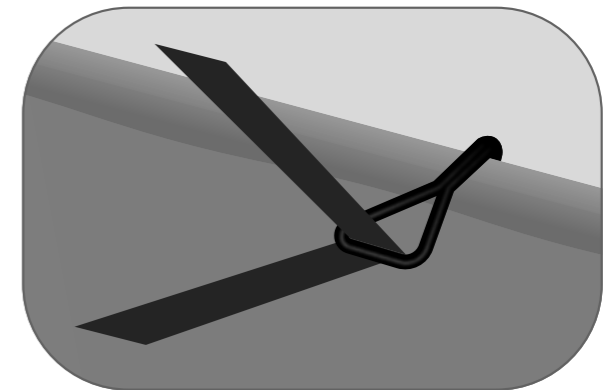

Hook it over the back bar.

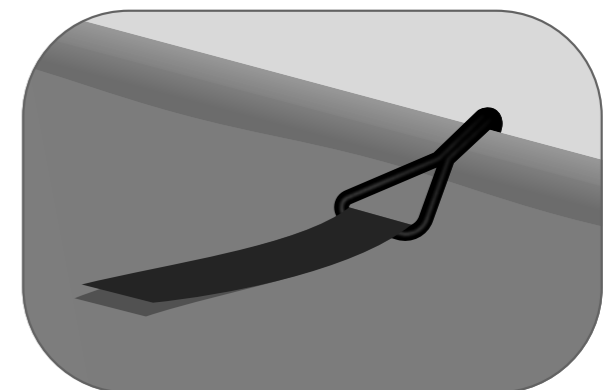

Pull firmly and reattach strip to the Velco.

## Step 8

Tighten screen with clips and velcro on the front bottom side of the enclosure.

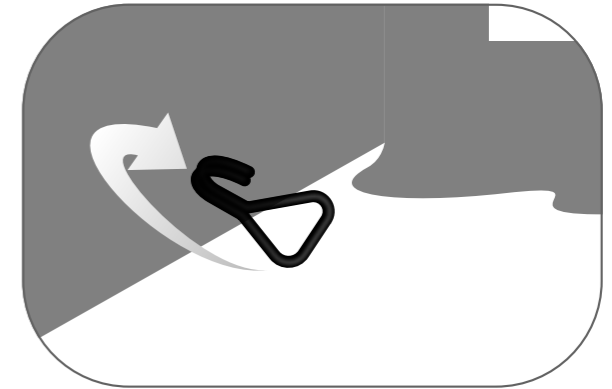
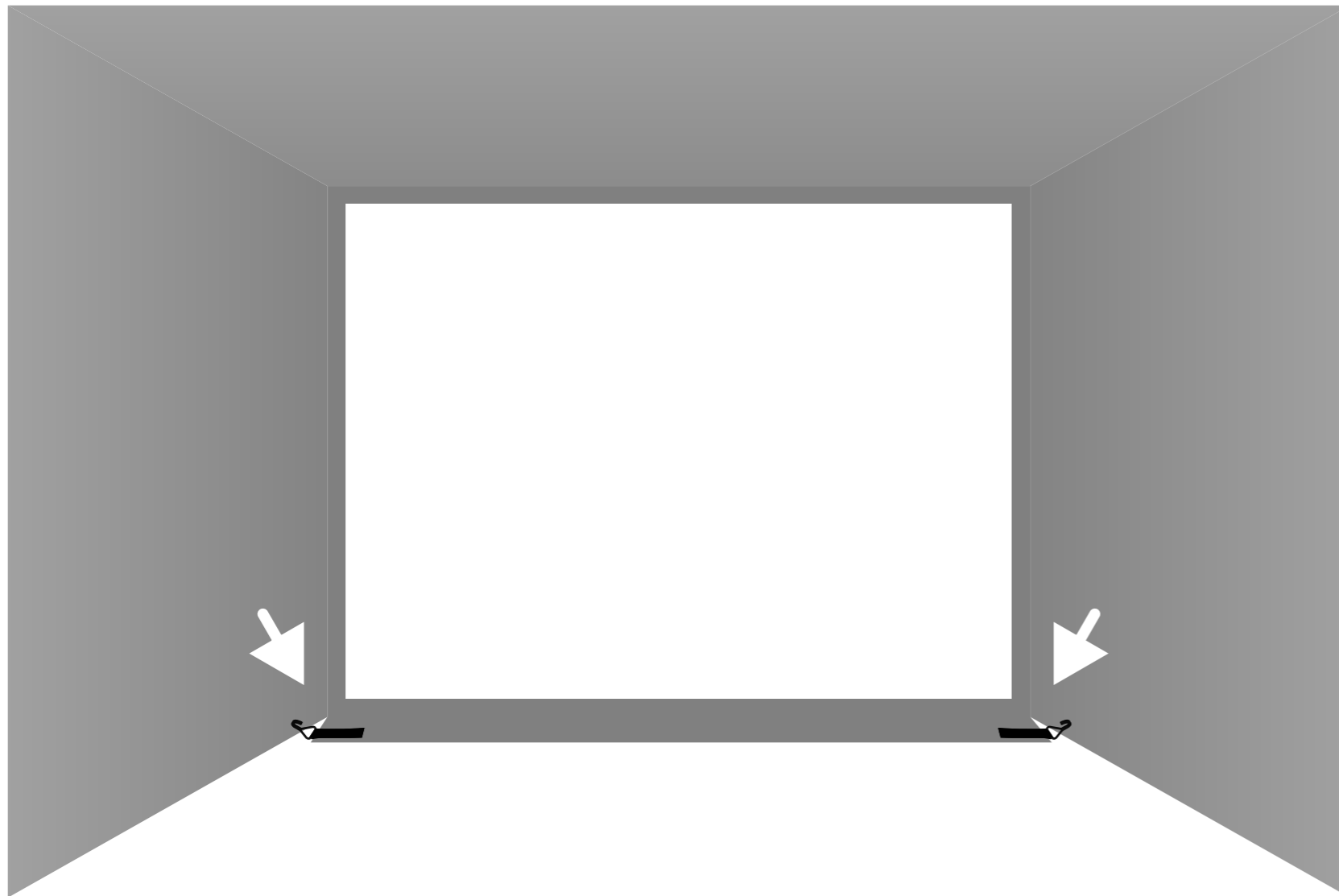

Slide the hook underneath the bottom side bar.

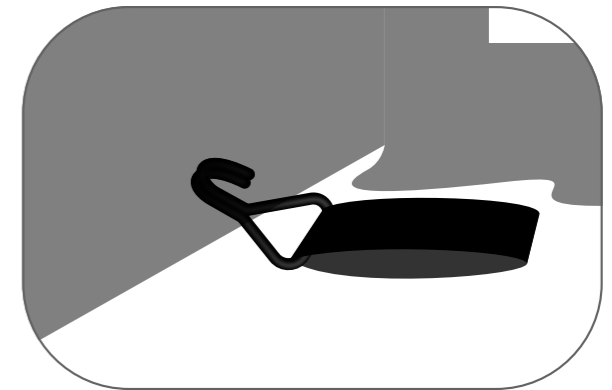

Slip the velcro through the clip and make a loop out of it.

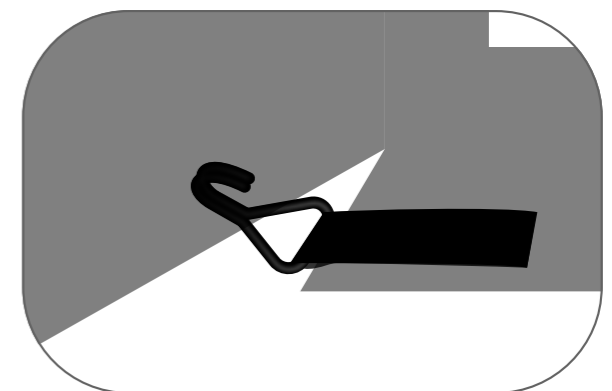

Pull the loop tight and put the bottom of the screen on it.

# Projector installation

What's in the box?

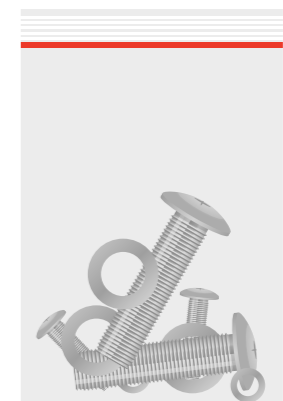
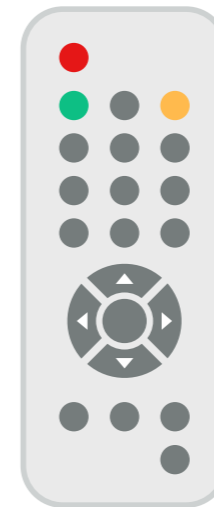
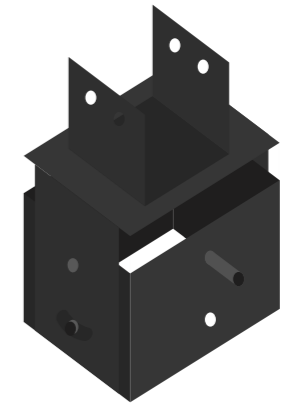
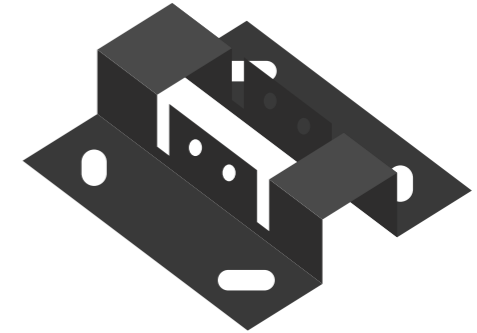
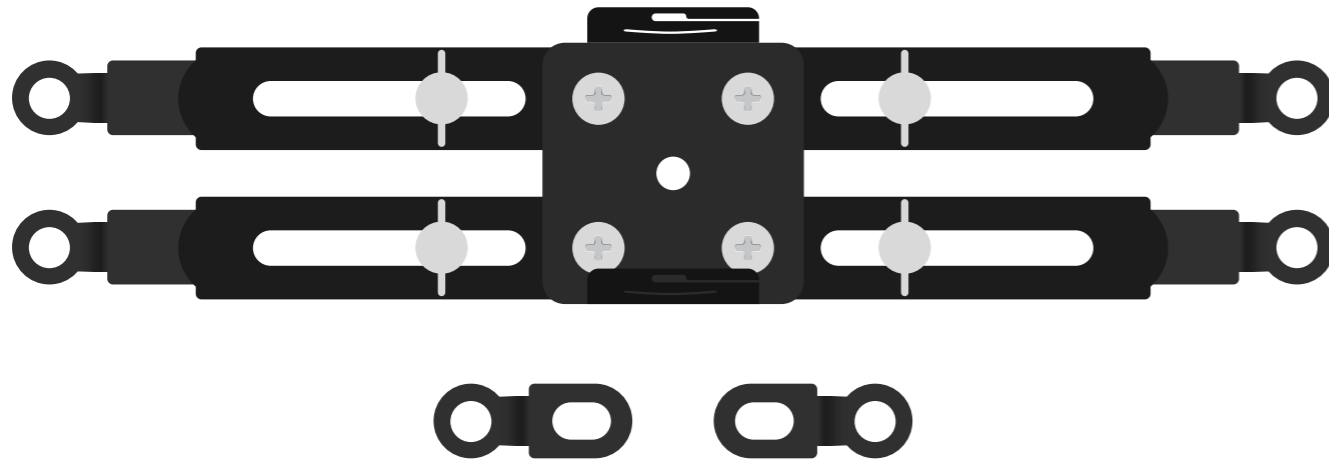



# Setting up the bracket



The bracket needs to be reassembled as it's shown on the picture below.  
Follow the instructions on the next slides.

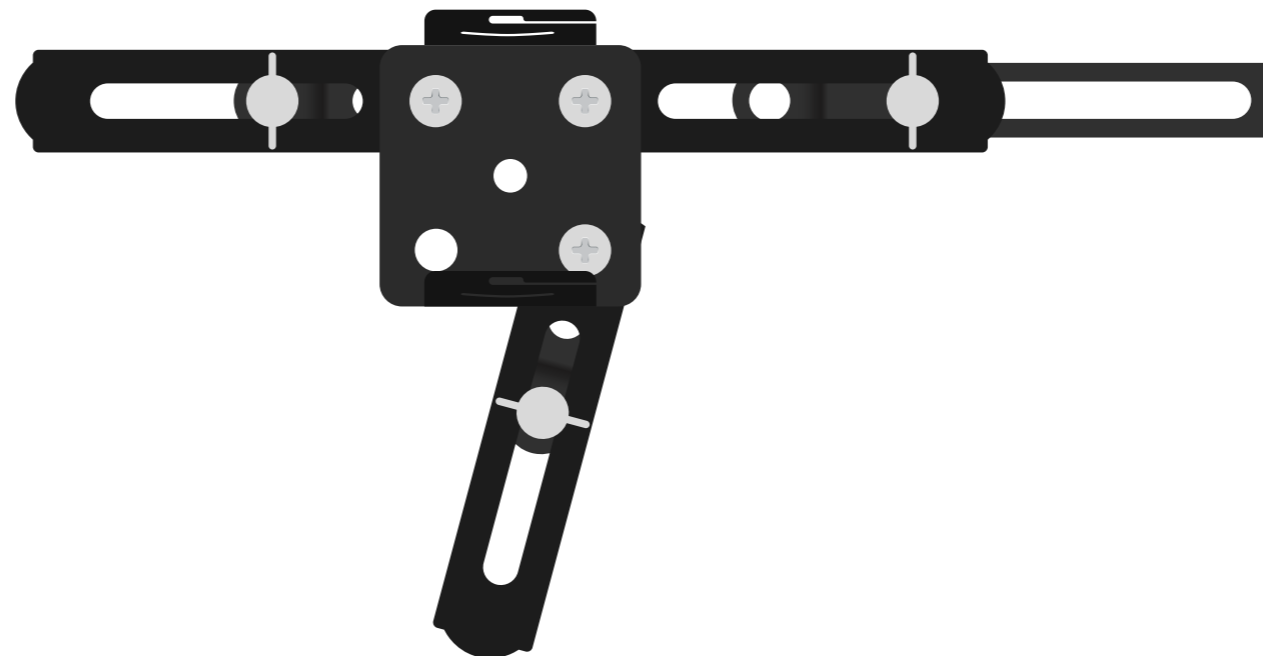

# Setting up the bracket

## Step 1



One of the arms is redundant and needs to be removed.

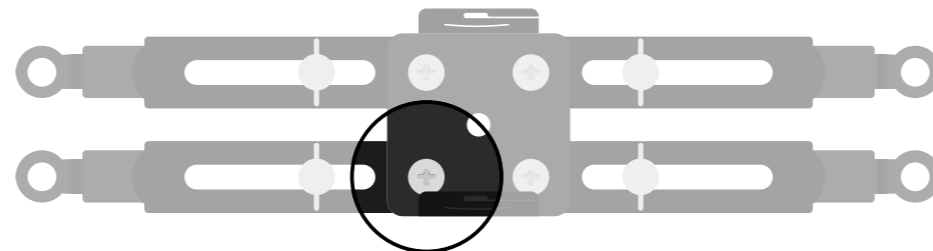

Unscrew this screw at the top using cross-head screwdriver.

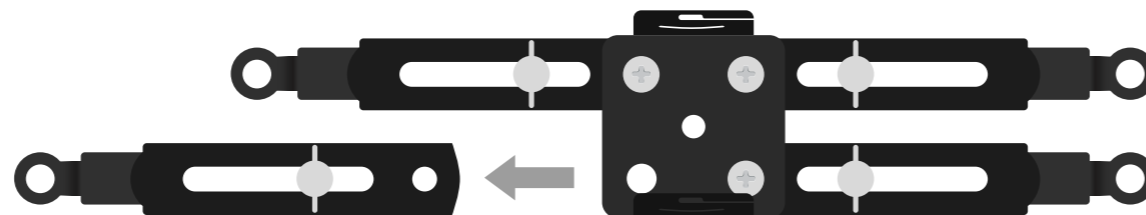

Remove the arm.

# Setting up the bracket

## Step 2

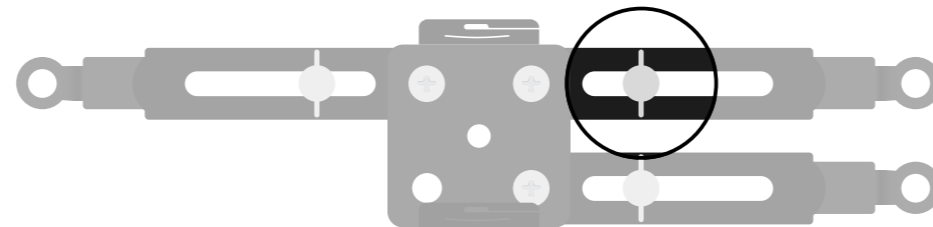

Loosen this particular arm wingnut and remove it.

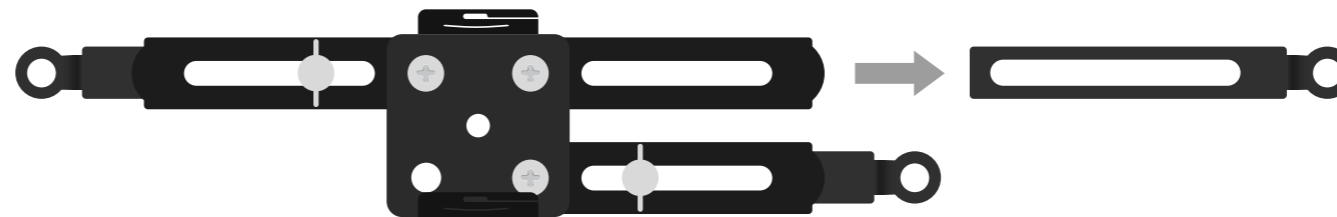

Slide out the long attachment.

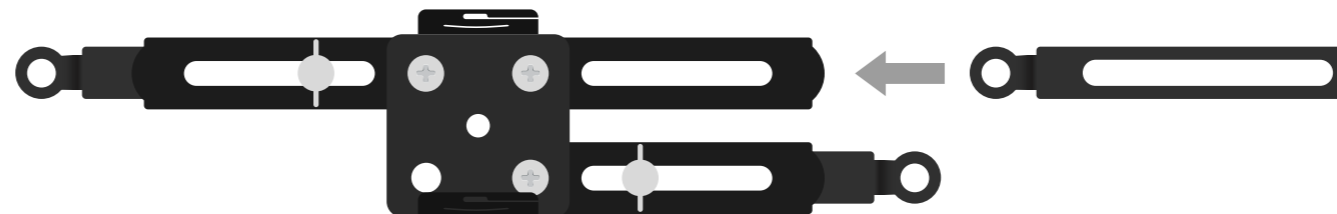

Turn the long attachment around and slide it back in.

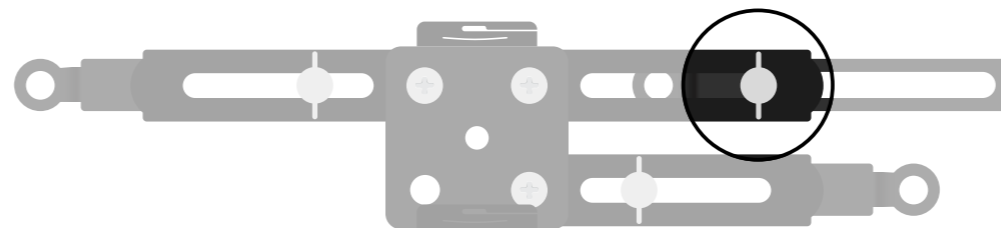

Tighten the arm wingnut in about this position.

# Setting up the bracket

## Step 3

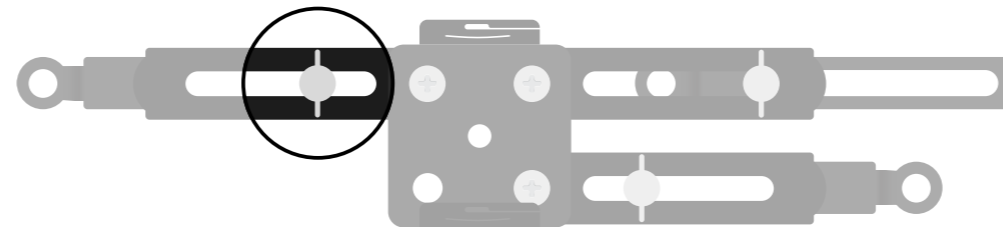

Loosen this particular arm wingnut and remove it.



Slide out the long attachment.

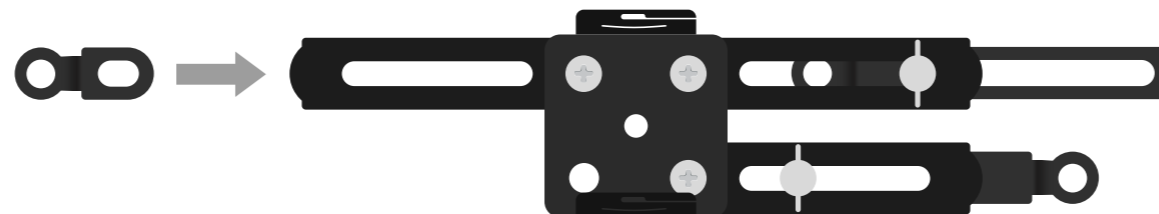

Take a short attachment and slide it in instead of long one.

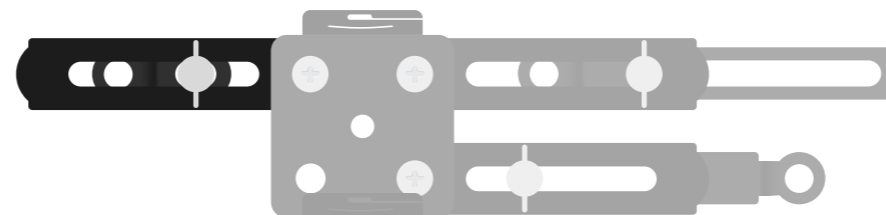

Tighten the arm wingnut in about this position.

# Setting up the bracket

## Step 4

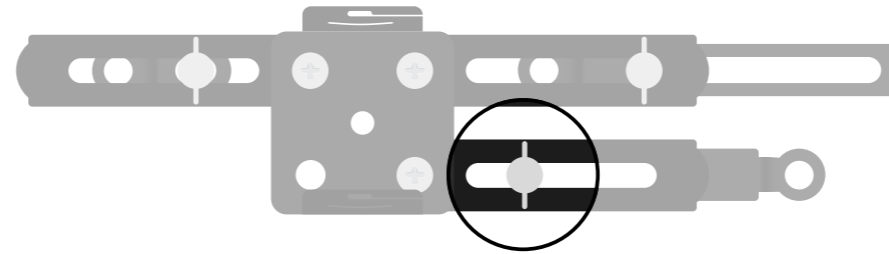

Loosen this particular arm wingnut and remove it.

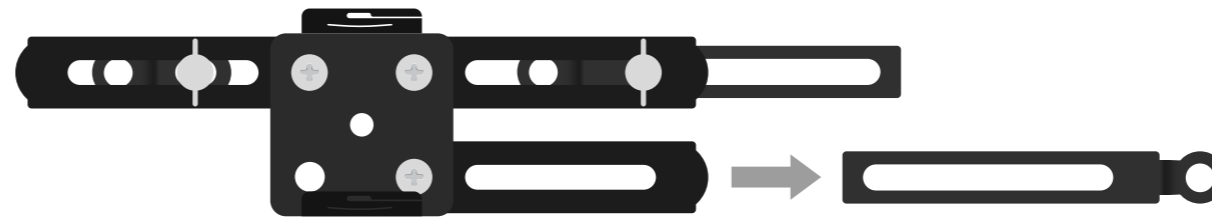

Slide out the long attachment.



Take a short attachment and slide it in instead of a long one.

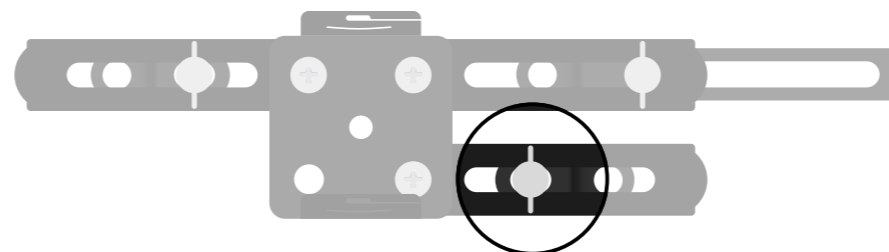

Tighten the arm wingnut in about this position.

# Setting up the bracket

## Step 5

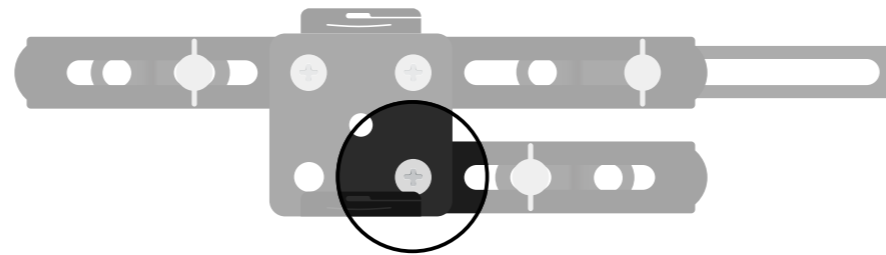

Loosen this screw at the top using cross-head screwdriver.

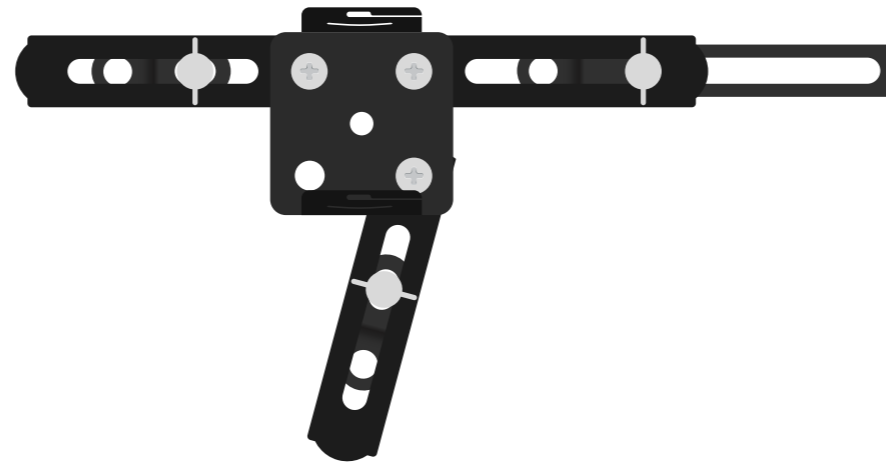

Rotate the arm to about this position and tighten the screw at the top.

## Positioning the bracket on the bottom of the projector

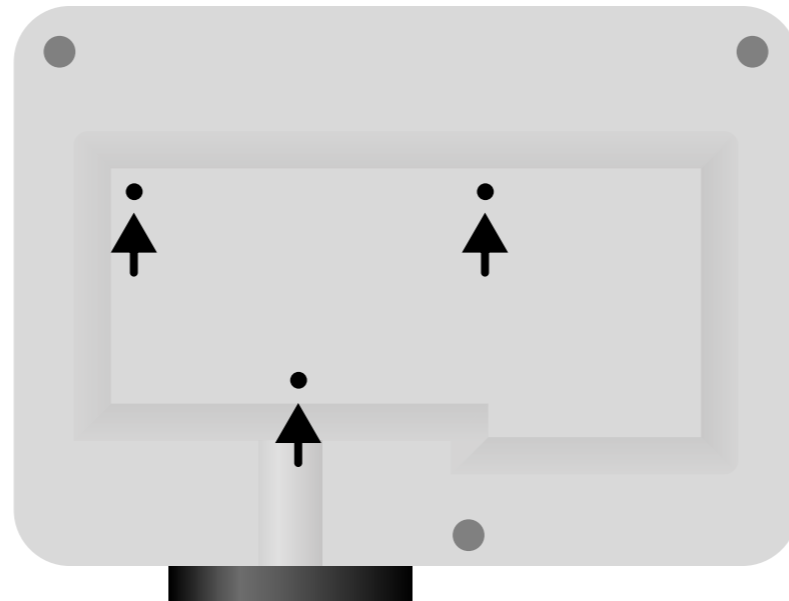

Turn projector upside down with the lens facing towards you and find three mounting holes.

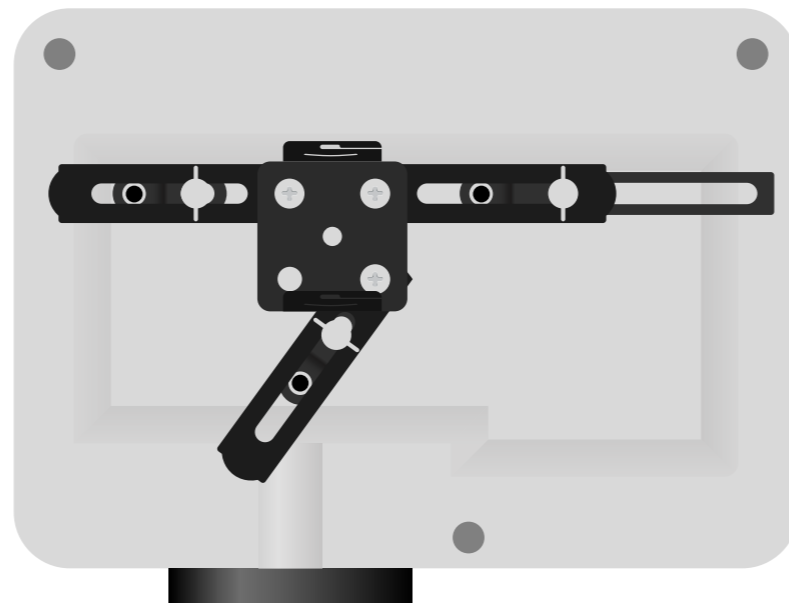

Ensure that when you position your recently formed bracket, the holes on it match up exactly to the holes on the bottom of your projector. Tighten the screws.

# Attaching the gimbal to the F Pole

The gimbal mount is welded on the F Pole.

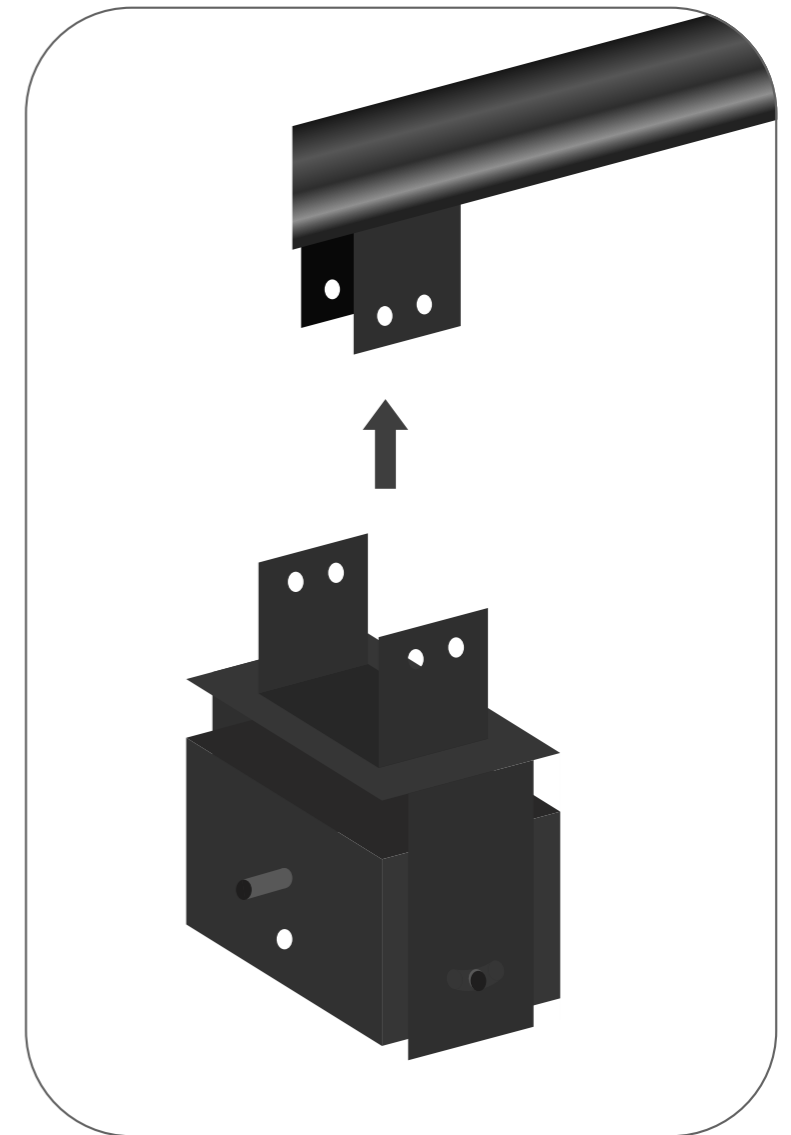
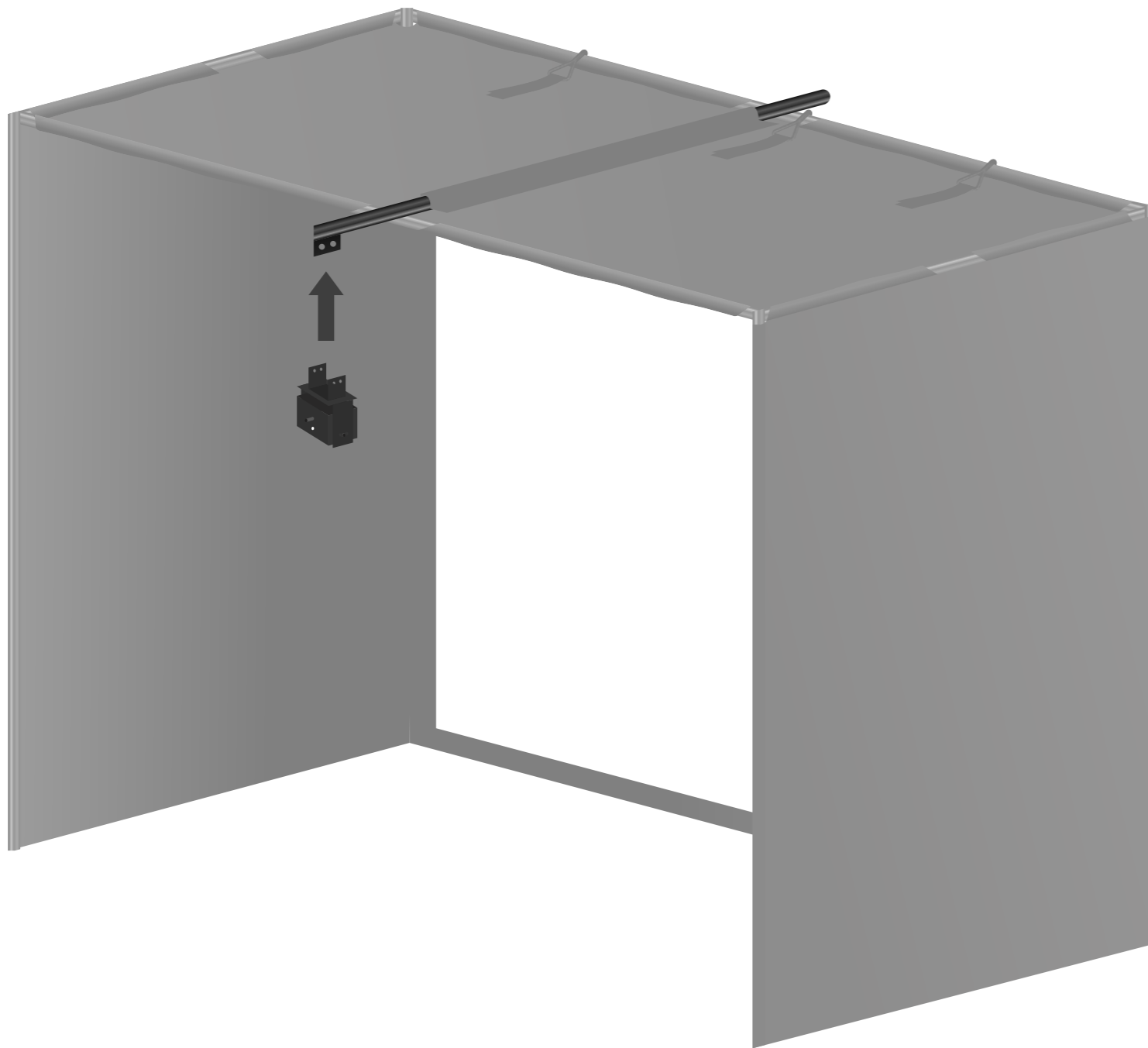

Line up the holes of the gimbal with the holes on the gimbal mount on the F Pole and simply screw four screws in.



## Attaching projector to the gimbal

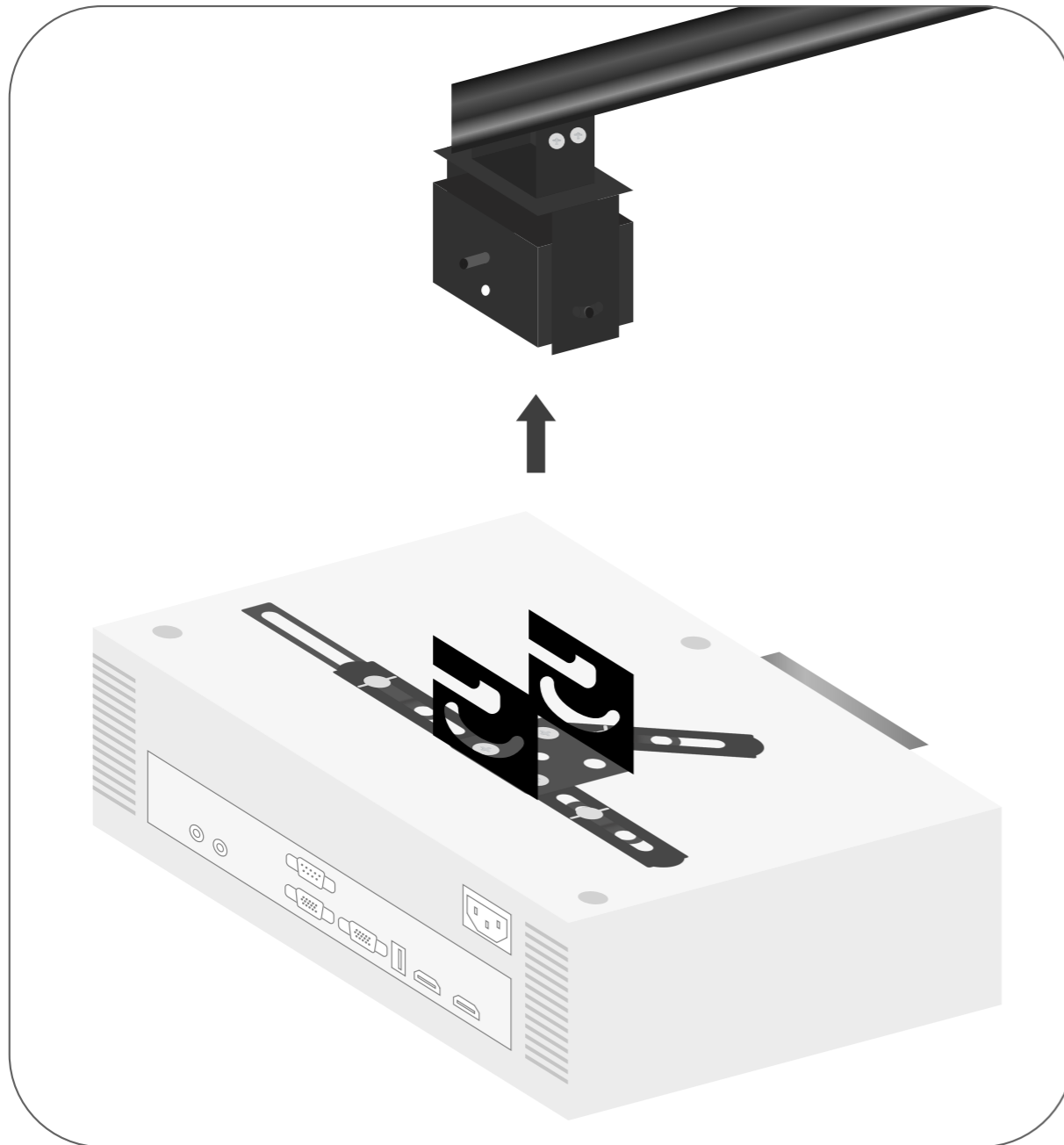

Hang the projector on the gimbal

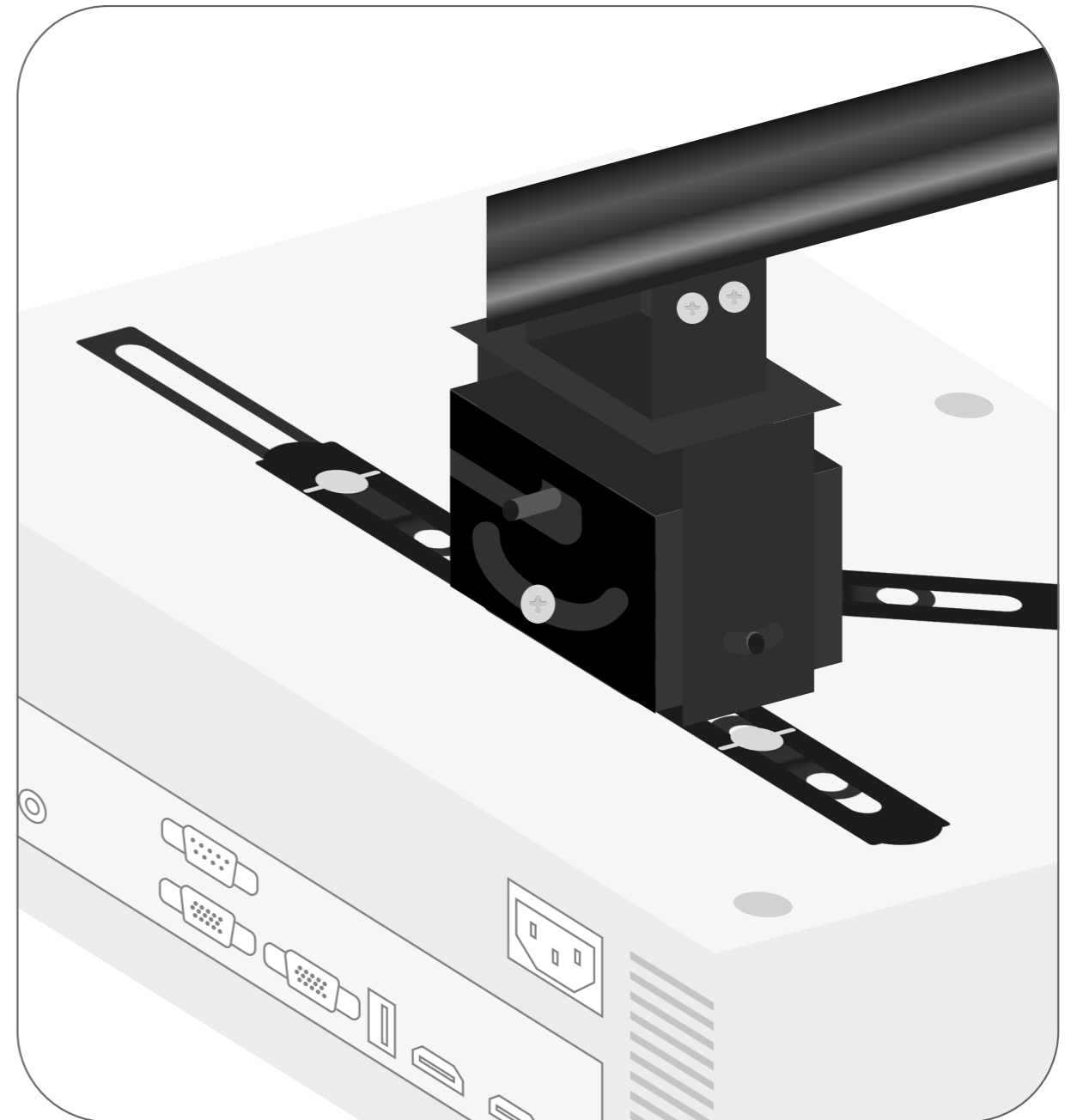

Screw one screw in as it shown on a picture and the other one on the opposite side of the gimble.

# Connecting the projector to the power

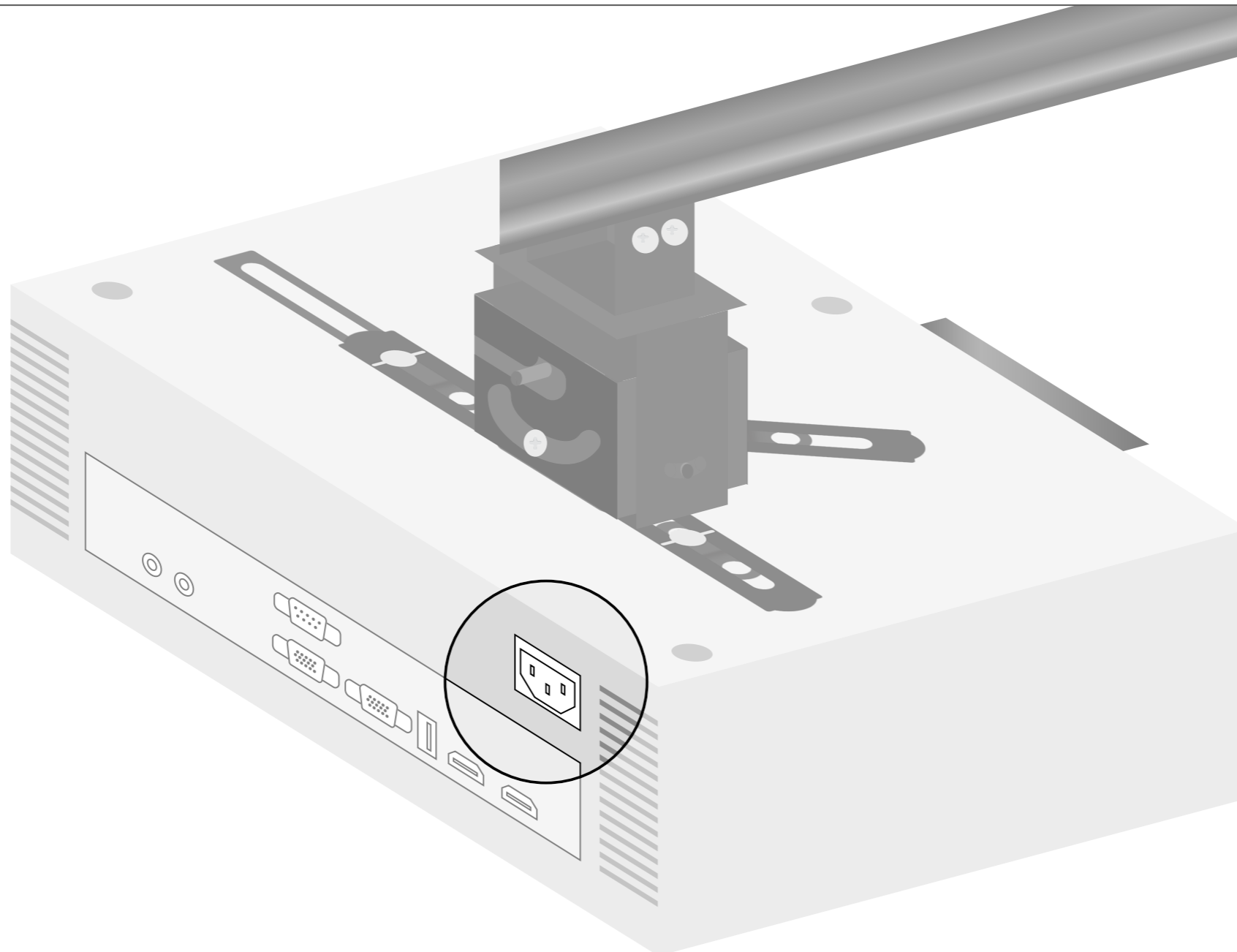

Plug in the power cord to the projector.

# Connecting HDMI cord to the projector

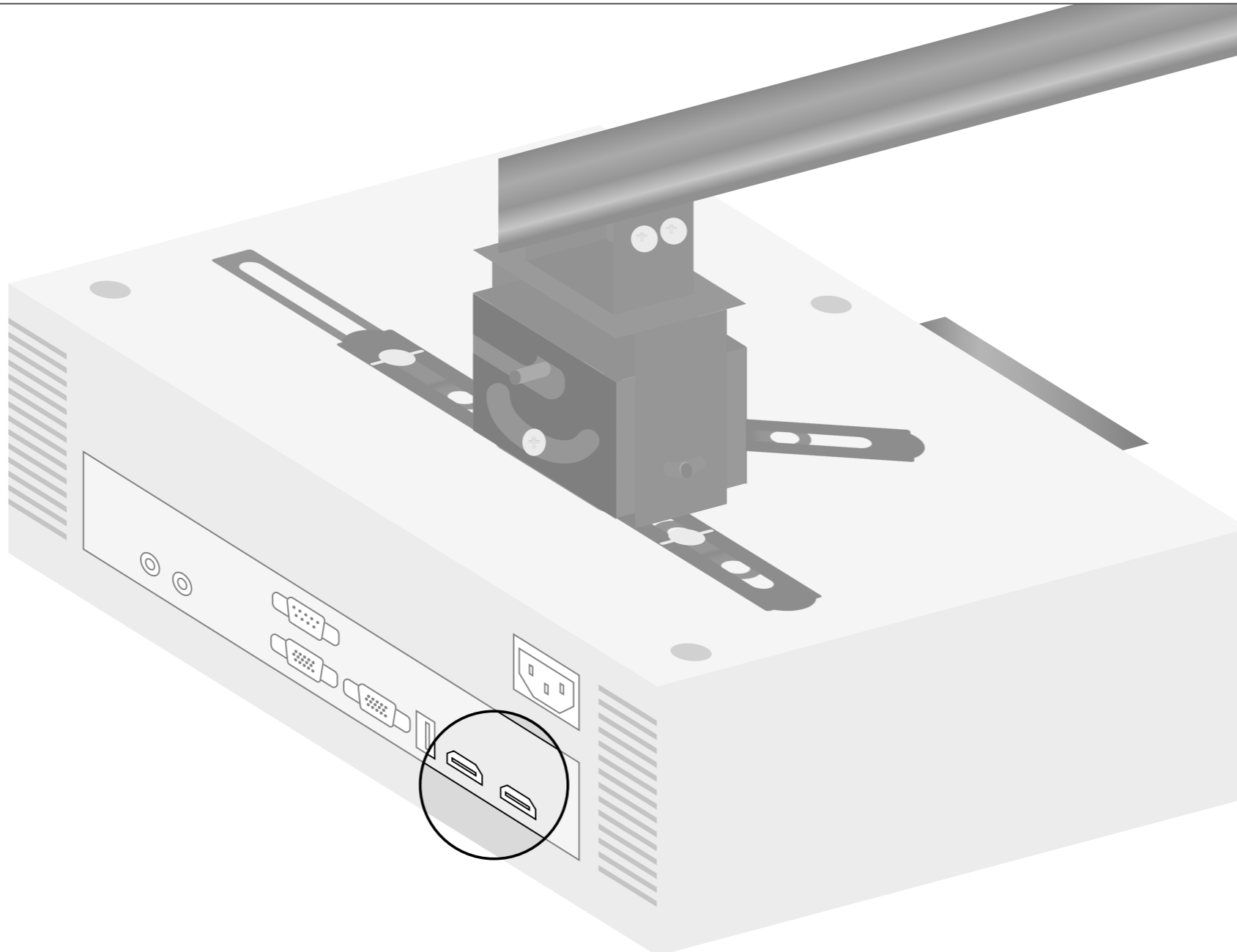

Plug the HDMI cable into either of the two HDMI ports