



# Corrective Therapy Device User Guide



Hi there.

This is it, the moment you've been waiting for. Your **Corrective Therapy Device** is here and ready to transform your back health. Follow these instructions to start your journey to lasting pain relief.



# Congratulations on your purchase of the NeuroMD Corrective Therapy Device

The NeuroMD Corrective Therapy Device utilizes patent pending NMES (Neuromuscular Electrical Stimulation) parameters based on clinical trial results to correct the source of the pain; not just the symptoms.

This innovative device is a safe, drug-free, easy to use, pain relief system which places the body in proper optimal function by starting at the source: the core and lower back. By healing, strengthening, and stabilizing the lower back, you will be able to live a more active, pain-free lifestyle.

Included is a 12 WEEK PROTOCOL (Page 8) and EXERCISE PROGRAM (Pages 12-15) that was developed based on a 2016 trial at The University of Delaware. The trial demonstrated trunk muscle training exercises in conjunction with the NMES technology; this exhibited clinically significant reduction in pain ratings and functional improvements in adults with chronic low back pain.



**IMPORTANT:** Please Read Entire User Guide Before Using Device.



For Additional Help & Video Tutorials Visit:  
[GetNeuroMD.com/Help](https://www.getneuromd.com/help)

## TABLE OF CONTENTS

Safety Precautions .....	2-3
Included in the box .....	4
Device and Remote Button Functions.....	5
Quick Start Guide .....	6-7
Corrective Care Protocol™.....	8
Helpful Tips .....	9
Charging Device.....	9
In-Depth Operation Guidelines.....	10
Storage and Maintenance .....	11
Electrode Gel Pad Usage .....	11
6 Simple Movements.....	12-15
Troubleshooting .....	16
Specifications and Function Guide.....	17
Warranty Information.....	18
Disposal Information .....	18
Frequently Asked Questions .....	19
Disclaimer.....	19



# Contraindication



Do not use this device if you have a cardiac pacemaker, implanted defibrillator, or other implanted electronic device, or are connected to high frequency surgical equipment.

# Warning

Do not allow children to handle, swallow or ingest accessories or parts.

Do not use this device across or through your chest any electrical currents introduced into the chest may cause rhythm disturbances.

Do not use this device over your eyes, mouth, face, front of neck, head, chest, or across your heart because this could cause severe muscle spasms resulting in difficulty in breathing and other adverse effects.

Consult with your physician before using this device if you are in the care of a physician.

Stop using this device and consult your physician if your pain does not improve, becomes more than mild, or continues for more than five days.

Do not use this device while driving, operating machinery, or during any activity in which electrical stimulation can put you at risk of injury.

Do not use this device over open wounds or rashes, or over swollen, red, infected, or inflamed areas or skin eruptions (e.g., phlebitis, thrombophlebitis, varicose veins).

Do not use this device if you are susceptible to rhythm disturbances to the heart unless under direction of your physician.

Do not use this device over, or in proximity to, metallic implants or cancerous lesions.

Do not use this device on children.

Do not use this device in the presence of electronic monitoring equipment (e.g., cardiac monitors, ECG alarms), which may not operate properly when the electrical stimulation device is in use.

Do not use this device when in the bath, shower or other sources of moisture.

Do not use this device while sleeping.

Do not use this device on abnormal skin, or skin that is not clean & healthy.

Do not operate in Close proximity (e.g. 1 m) to shortwave or microwave therapy equipment as it may produce instability in the device output.

# Precautions



**DO NOT START stimulation of the device prior to application of the device to the back.**

Keep this device out of the reach of children.

Do not use this device if you are pregnant, or suspect that you are pregnant, unless under the direction of your physician.

This device should not be applied on or across your head or face.

If you have suspected or diagnosed heart disease, you should follow precautions recommended by your physician.

If you have suspected or diagnosed epilepsy, you should follow precautions recommended by your physician.

Use this device with caution if you have a tendency to bleed internally, such as following an injury or fracture.

Consult with your physician prior to using this device after a recent surgical

procedure, because stimulation accelerates the healing process.

Do not use this device for pain of central origin, including headache.

Use this device with caution if stimulation is applied over areas of skin that lack normal sensation.

Do not remove this device from your skin with the stimulation mode of operation activated.

Do not place your finger, or any object, between or near your skin and the adhesive gel pads during stimulation treatment.

This device is not to be used in the presence of flammable gases.

Handle the unit with care. Inappropriate handling of the unit may adversely affect its characteristics.



## DISCLAIMER

Always consult with your physician before starting any new exercise program or treatment modality.

# Adverse Reactions

In rare cases you may experience skin irritation due to the electrical stimulation or adhesive medium (gel pads). Please ensure the treatment area is cleaned properly and the electrode gel pads are making adequate contact with the skin.

Stop using the device and consult with your physician if you experience adverse reactions from use of this device.

# What's Included



Corrective Therapy Device



Wireless Remote Control

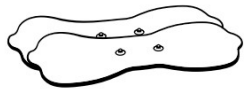

X2 Electrode gel pad



Pad ziplock storage bag

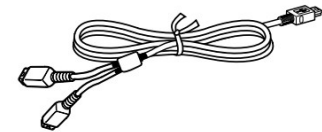

USB-C Charging Cable for Device and Remote

# Device and Remote Button Functions

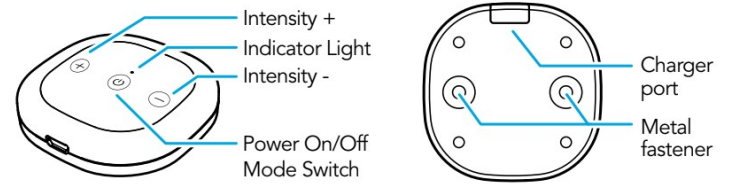

**i** The device and remote need to both be turned on by pushing the power button on each component

The remote will not power on the device; however, it will turn it off. The device and remote need to both be turned on by pushing the power button on each component. The remote uses Radio frequency and will only communicate with the device after, the device is turned on manually. This reduces battery consumption and prevents the device from needing to be in a standby mode at all times.

It is recommended to increase the intensity via the **+** button to as high as you can tolerate.

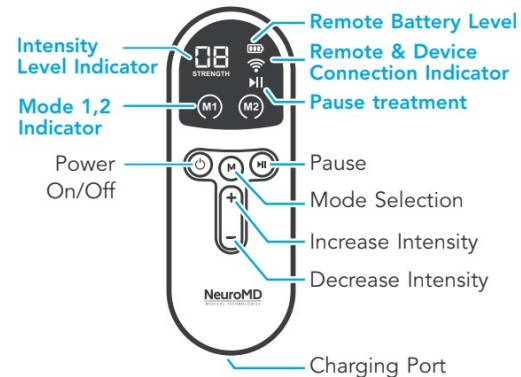

**i** After both the device and remote are powered on, the remote will display the connection indicator symbol .

# Quick Start Guide

## 1 Charge Device and Remote

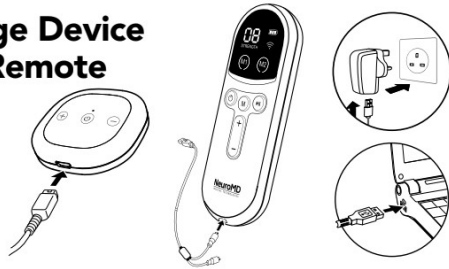

## 2 Prepare treatment area

**TIP:**  
A clean treatment area helps maintain electrode stickiness and longevity.

Trim, do not shave, excessive hair on treatment area. Wash the skin and dry completely. (Treatment area should be void of any lotions/oils.)

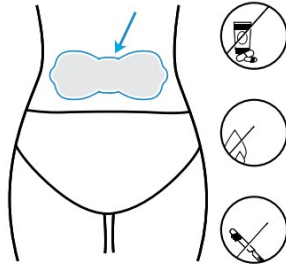

## 3 Attach device to electrode pad

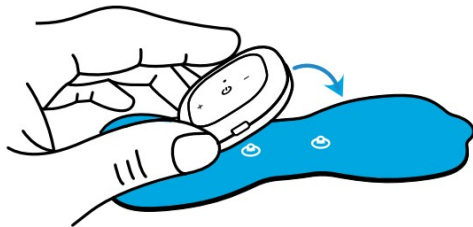

## 4 Turn on device and remote

Once the device and remote are on,  icon will display on remote screen indicating they are connected.

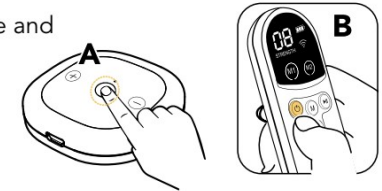

**NOTE:** If you are having difficulty connecting, please try inverse powering by first turning on the remote and then powering on the device second.

## 5 Apply device

Remove protective film, apply device to back and begin increasing intensity.

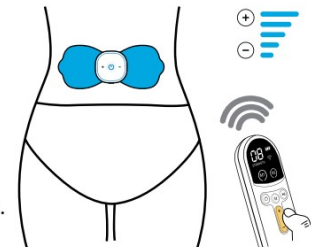

**NOTE:** Only increase intensity after fully adhered to the skin.

## 6 After completing treatment

Re-apply protective film to the bottom of electrode pad and store in ziplock pouch.

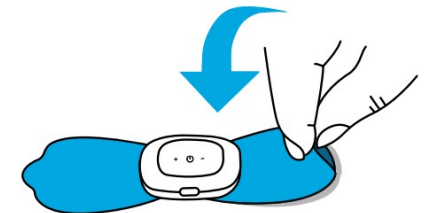

 For Additional Help & Video Tutorials Visit:  
[GetNeuroMD.com/Help](https://www.getneuromd.com/help)

# Corrective Care Protocol™

## WEEK 1

### Mode 1

4 days / week  
25 min / session



Indicated by the **M1** symbol on the left side of the remote screen.

## WEEK 2-12

### Mode 2

5-6 days / week  
25 min / session



Indicated by the **M2** symbol on the right side of the remote screen.

## WEEK 13+

### MAINTENANCE PHASE

### Mode 2

2-4 days / week  
25 min / session



Indicated by the **M2** symbol on the right side of the remote screen.



**Studies show that statistically significant pain relief can take 4+ WEEKS. Staying consistent is key!**

## Helpful Tips

- Increase intensity to as high as tolerable. Studies found that the higher the Intensity the greater the results.
- After each session, it's important to complete the exercises and stretches found on pages 12-15.
- Majority of users experience significant pain relief early/midway into the protocol. However, we strongly recommend completing the full 12 weeks and staying physically active to maintain lasting relief.
- Similar to starting an exercise program, you may experience mild muscle soreness after the first few sessions.

## Charging Device & Remote

### STEP 1

Connect the USB cable with the device and remote

### STEP 2

Connect the USB cable with suitable adapters. (Smart-phone adapters and computer USB ports are suitable).

### STEP 3

The estimated full charge time for the device and remote is 1 hour.

The light on the Device is red during charging and when fully charged, the light will turn blue.

When the remote is charging, the battery symbol will recirculate from 1 to 3 bars. When the remote is fully charged, the battery symbol  mark will steadily show 3 bars.

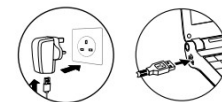

## M Mode Selection

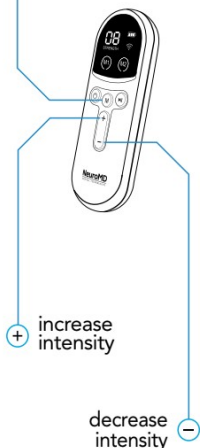

## How to begin the treatment

**Always Press the button on the remote and the device.** The remote will not power on the device; however, will turn it off. The device and remote need to both be turned on by pushing the power button on each component. When both the remote and device are on, the remote will display the symbol.

Peel off the protective film on the gel pad and attach the pad to the center of the lower back. A friend or family member may assist. (Save the protective film as you will reuse this.) You can do the treatments however you feel comfortable (sitting, standing, lying down, etc.... After the device is fully adhered to skin, begin gradually increasing the intensity. Be mindful when sitting or lying down not to apply excessive pressure to the device as it can cause damage.

**Adjusting Intensity:** Press or button to adjust intensity; Increase intensity to as high as tolerable. Device contains 30 levels of intensity and always starts at 0 Intensity. It may take several intensity increases before feeling the stimulation. A 10 second delay between pulses is normal.



Press to change modes

Device always starts on **Mode 1**. After the device is on, to change to **Mode 2**, simply press the button one time.

**Mode 1:** helps acclimate the body to the stimulation.  
**Mode 2:** is stronger and will target deeper tissues.

Press to pause the device. There is no output current while the device is paused.

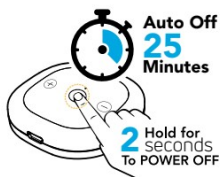

The device is designed to shut down automatically after working for 25 minutes. Press "" on remote or device for manual powering off. Always turn off before removing from skin.

After treatment and device is off, slowly peel the edge of pad away from skin. Reapply the protective film to the gel pad and store in zipper storage pouch.

## Storage and Maintenance

- Fully charge the battery before long-term storage and charge it every two or three months to extend the life of the battery.
- Use baby wipes to clean any stains or dust on device.
- If the electrode has become dirty, you may use a wet towel to gently clean the electrode pad. This will help improve pad adhesiveness.
- The Electrode pad needs to be replaced when it no longer adheres to the skin. (Approximately 30 applications)  
Purchase replacement pads at [GetNeuroMD.com](http://GetNeuroMD.com)



Store device in original packaging. **Please DO NOT USE or STORE** this device under the following circumstances:

- in the sun
- in dusty environment
- near fire or heat
- in humid environment
- electromagnetic environment

## Electrode Pad Usage

Make sure the skin is clean and does not contain any lotion before applying pad. The electrode pad is a consumable and will last about 30 applications depending on your skin type, oils, and pH levels. When a replacement is needed, please purchase electrode pads from our website: [GetNeuroMD.com](http://GetNeuroMD.com)



If the electrode has become dirty, you may use a wet towel to gently clean the electrode pad. This will help improve pad adhesiveness.



# 6

1-3

## Simple Movements

After each NeuroMD session



A 2016 trial at The University of Delaware, demonstrated trunk muscle training exercises in conjunction with the NMES technology showed clinically significant reduction in pain ratings and functional improvements in adults with chronic low back pain.

## 1 RECLINING PIGEON POSE

This is the #1 Rated stretch to alleviate sciatica pain and is the most widely prescribed movement by physical therapists.

- While on your back, bring your right leg up to a right angle.
- Clasp both hands behind the thigh, locking your fingers
- Lift your left leg and place your left ankle on top of the right knee.
- Hold the position for a moment. This helps stretch the tiny piriformis muscle, which sometimes becomes inflamed and presses against the sciatic nerve, causing pain.
- Do the same exercise with the other leg.

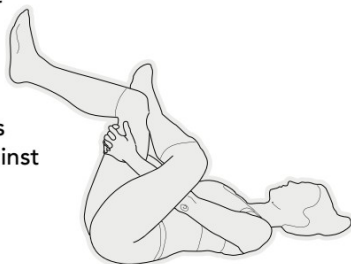

## 2 PARTIAL CRUNCH

Partial crunches are one of the safest and easiest ways to build strong abdominal muscles which, play a significant role in supporting the spine and help keep the hips properly aligned. Weak abdominals will result in poor core strength and lack of stability.

- Lie back on the floor and bend the knees, keeping the feet flat and hip-width apart.
- Cross the hands over the chest. Breathe in deeply. On the breath out, engage the abdominal muscles by pulling in the stomach.
- Gently raise the head and shoulders 2 inches off the ground while keeping the neck in line with the spine. Hold for 5 seconds then return to the starting position.
- Repeat the exercise 10-15 times. Take 30 second rest between sets. Perform 4 sets.



4 Sets  
For 10-15 Reps

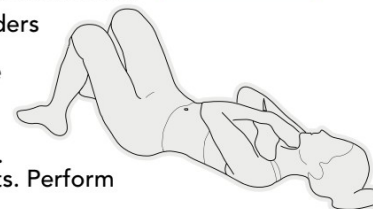

## 3 KNEE TO CHEST

Many doctors state the importance of this simple stretch and see patients experience profound improvements with spinal arthritis and spinal stenosis.

- Lie flat on your back, ensuring your toes are pointed to the ceiling.
- Slowly bend your right knee and pull your leg toward your chest.
- Wrap your arms around your thigh, knee or shin, and gently pull the knee towards your chest.
- Hold for 20 seconds and slowly extend the leg into starting position.
- Repeat three times for each leg.
- Do the same exercise with the other leg.



3 Stretches  
per leg



# 6

4-6

## Simple Movements

After each NeuroMD session

### 4 YOGA CAT/COW

This is the most versatile movement that both strengthens and stretches the core and lower back muscles. With this stretch, flexing and extending the spine also improves mobility in the spinal discs.

- Position knees, shins, and hands hip width apart on floor.
- Center your head in a neutral position and soften your gaze downward.
- Begin by moving into Cow Pose: Inhale as you drop your belly towards the mat. Lift your chin and chest, and gaze up toward the ceiling.
- Broaden across your shoulder blades and draw your shoulders away from your ears.
- Next, move into Cat Pose: As you exhale, draw your belly to your spine and round your back toward the ceiling. The pose should look like a cat stretching its back.
- Release the crown of your head toward the floor, but don't force your chin to your chest.
- Inhale, coming back into Cow Pose, and then exhale as you return to Cat Pose. Repeat 5-10 times, and then rest by sitting back on your heels



5-10  
Movements  
To Each Position

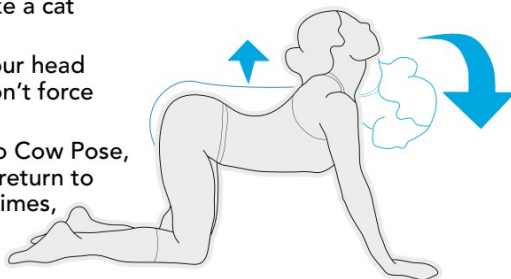

### 5 THE BRIDGE

This exercise engages your glutes, and your glutes are part of your core, just make sure to only lift your hips to the point where your glutes are engaged, and not so far that you hyperextend your back.

- Lie on your back with your hands at your sides, knees bent, and feet flat on floor hip-width apart.
- Squeeze your glutes and abs and push through your heels to lift your hips a few inches off the floor until your body forms a straight line from your shoulders to your knees.
- Hold this position for a second, making sure your knees stay straight and don't collapse in.
- Slowly lower your hips to return to the starting position.



4 Sets  
For 10-15 Reps

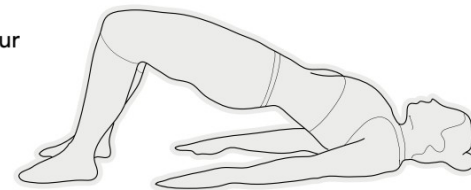

### 6 LYING KNEE TWIST

With this stretch you will experience improved posture, spinal mobility, and relaxed paraspinal muscles.



- Lie on your back with your legs extended straight out.
- Bend the right knee up and cross it over the left side of your body.
- Hold in a position that allows you to feel a gentle stretch through the back and buttocks muscles for 20 seconds.
- Tighten your core muscles and rotate back to center.
- Repeat this exercise three times on each side.

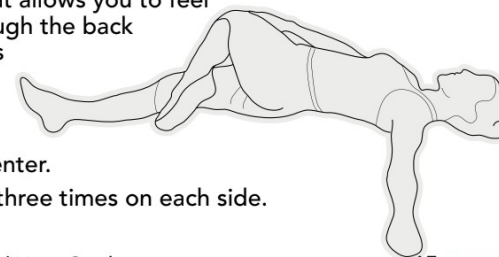

4 Sets  
For 10-15 Reps



# Troubleshooting Guide

Problem	Cause	Solution
Remote or Device is not working	The device and remote need to both be turned on by pushing the power button on EACH component.	Push the power button on center device, then press power button on remote. When both the remote and device are on, the remote will display the  symbol
Cannot feel any stimulation	The intensity level is not properly adjusted.	Press the  button until stimulation is felt.
	Gel pads are not firmly attached to the skin.	Attach the gel pads firmly to the skin.
	The adhesive surface of the gel-pad is damaged.	Replace it with a new gel pad.
Electrical stimulation is too weak	The adhesive surface of the gel-pad is dirty or dusty.	See Storage & Maintenance and clean the gel pad. (Page 11)
	The battery is very low.	Charge the device.
	The adhesive surface of the gel pad is damaged.	Replace with a new pad.
Electrical stimulation is too strong	The adhesive surface of the gel pad is dirty or dusty.	See storage & maintenance clean the gel pad. (Page 11)
	The intensity level is too high or pads are not attached correctly.	Press the  button to decrease intensity.
Stimulation stopped unexpectedly	The battery is very low.	Charge the device.
Gel Pad won't stay firmly attached to the skin	The adhesive surface of the gel sheet is dirty or dusty.	See storage & maintenance (Page 11) Clean Gel Pad.
	The adhesive surface of the gel pad is damaged.	Replace it with a new pad.
The skin turns red or becomes irritated	The gel pads are not firmly attached to the skin.	Make sure skin is clean and attach gel pad firmly to skin. (no lotion/oils)
	Adhesive surface of gel pad is damaged, dirty, or dried out.	See storage & maintenance. (Page 11)



For troubleshooting the device, It is easier to perform tests when applied about 3 inches above the knee, instead of applied to the lower back.

## Specifications and Function

Charging Voltage	5V
Fully Charged	approx. 40min.
Duration	approx. 300min
Name	Corrective Therapy Device
Device Intensity	30 Levels
Max. output	2.5w
Standby Current	85uA
Battery Capacity	3.7V/180mA Polymer rechargeable battery
Battery Duration	About 6-12 sessions
Stimulation modes	2
Operation Time	25min
Material	ABS
Size	Length&Width 58mm Height 12.5mm
Weight	24g
Operation Temperature	0°C~45°C (32°F ~113°F)



**CTD DEVICE**

### REMOTE CONTROL



Name	Corrective Therapy Device Remote
Size	102*38*13mm
Battery	Rechargeable Lithium Battery
Input Voltage	3.7V
Standby Current	24.2mA
Working Current	23.5mA
Material	ABS
Weight	32g
Operation Temperature	0°C~45°C (32°F ~113°F)



Need Help? Visit: [GetNeuroMD.com/Help](https://www.getneuromd.com/help)

# Warranty Information



For warranty and return information please visit: [GetNeuroMD.com/Warranty](https://www.getneuromd.com/Warranty)



Call us at [877-300-9062](tel:877-300-9062) or email us at [Help@GetNeuroMD.com](mailto:Help@GetNeuroMD.com) to receive an RMA number prior to returning.



**NeuroMD**  
706 Baker Ct (south/right side of bldg.)  
High Point, North Carolina 27263

# Disposal Information

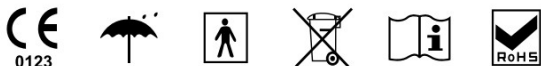

The crossed-out dustbin symbol indicates that this device should not be treated as household waste, but rather be brought to the appropriate collection point for recycling of electrical and electronic equipment. By ensuring this device is disposed of correctly, you will help prevent the potential negative consequences for the environment and human health which could be caused by inappropriate waste handling of the product. The recycling of materials will also help conserve natural resources.

**For more information about the recycling of your device, please contact your local household waste disposal service or your place of purchase.**

# Frequently Asked Questions

- Q Why is there a 10 second delay between pulses?**  
**A** The 10 second delay is very important as it helps reduce muscle fatigue and optimize muscle performance.
- Q Can I use the Corrective Therapy Device more often?**  
**A** Studies show that increasing duration of treatment was not directly related to more successful outcomes; positive benefits were seen with short programs (2-2.5 hours/week).
- Q Whats the difference between Modes 1 and 2?**  
**A** Mode 2 has a 200 Microseconds ( $\mu$ s) longer pulse duration and 20hz frequency increase; this assists in activating deeper secondary layers of muscles such as the deep spinal stabilizing muscles.

# Disclaimer

Users of this device do so at their own risk. Neither NeuroMD nor its retailers assume any responsibility or liability for any injuries or damages, physical or otherwise, resulting, directly or indirectly, from the use of this device.

Further, NeuroMD reserves the right to revise this publication and to make changes from time to time in the contents thereof without obligation to notify any person of such revision or changes. Any changes or modifications not expressly approved by the party responsible for compliance could void the user's authority to operate the equipment.

This device complies with part 15 of the FCC Rules. Operation is subject to the following two conditions: (1) This device may not cause harmful interference. (2) This device must accept any interference received, including interference that may cause undesired operation.

## RF EXPOSURE STATEMENT

This equipment complies with FCC radiation exposure limits set forth for an uncontrolled environment. The device has been evaluated to meet general RF exposure requirement. The device can be used in portable exposure condition without restriction. Model may be changed for improvements without notice.



FDA 510k Cleared Medical Device 890.5850.  
Patent-Pending. © All Rights Reserved

VERSION: V4USBC