

MODEL : WEBSTER OCCASIONAL CHAIR

ASSEMBLY INSTRUCTION

ASSEMBLY TIPS : Remove hardware from box and sort by size. Check that all hardware and parts are present before assembling. Following instruction below in proper sequence to ensure fast, easy and correct assembly.

WARNING : DO NOT FULLY TIGHTEN ALL BOLTS UNTIL ALL PARTS IN PLACE. FAILURE TO FOLLOW THIS INSTRUCTION MAY CAUSE THE BOLTS TO BE MISALIGNED DURING THE ASSEMBLY.

Part List

Step 01

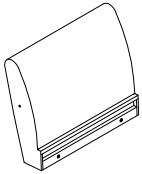
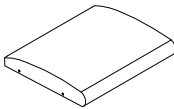
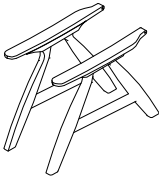

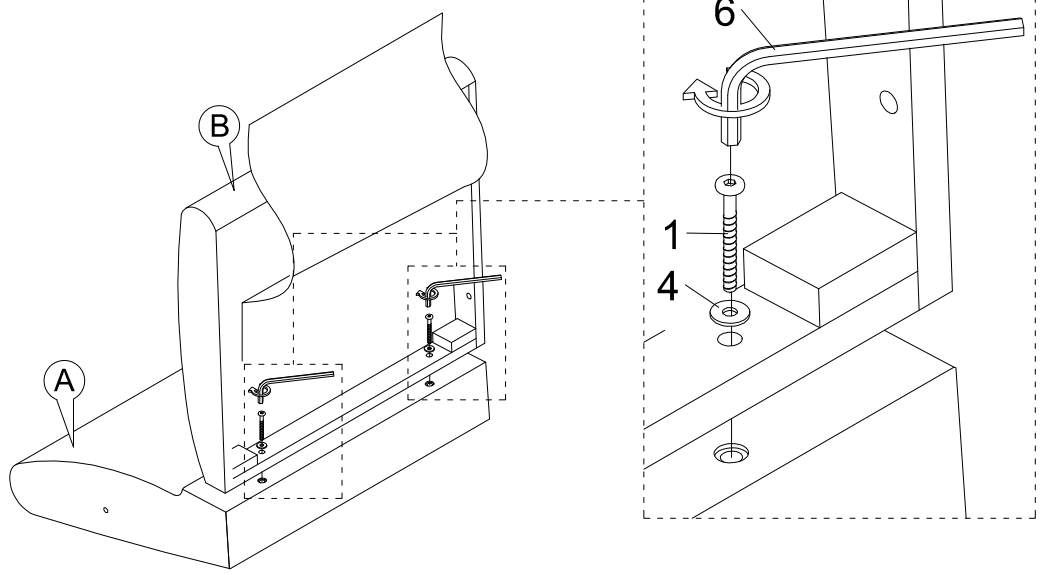

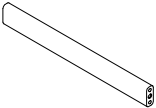

A		x 1
B		x 1
C		x 2

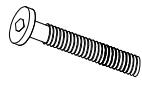

Step 02

D		x 1
---	--	-----

Hardware List

1		
	JCBC M6 x 60 mm	
2		x 4
	Wood Dowel M8 x 30 mm	
3		x 2
	Spring Washer	
4		x 4
	Flat Washer M6	
5		x 6
	JCBC M6 x 40 mm	
6		x 1
	Allen Key M4	

