

ASSEMBLY TIPS : Remove hardware from box and sort by size. Check that all hardware and parts are present before assembling. Following instruction below in proper sequence to ensure fast, easy correct assembly.

WARNING! : DO NOT FULLY TIGHTEN ALL BOLTS UNTIL ALL PARTS IN PLACE. FAILURE TO FOLLOW THIS INSTRUCTION MAY CAUSE THE BOLTS TO BE MISALIGNED DURING THE ASSEMBLY.

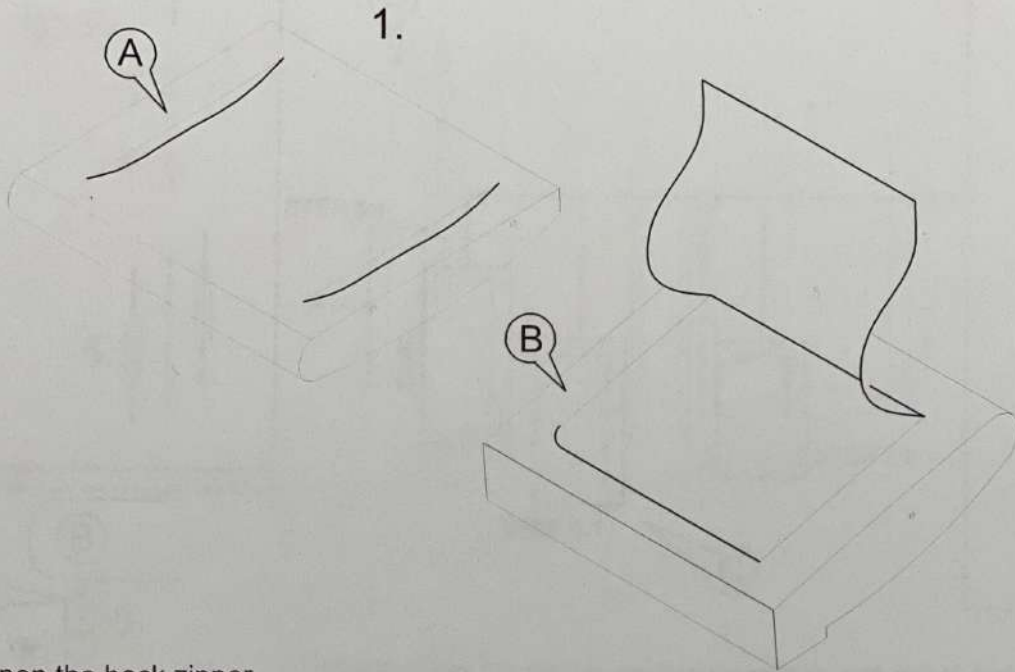

STEP 1



*Pull open the back zipper.

Make sure to install on a clean, open space to avoid scratches

PART

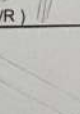



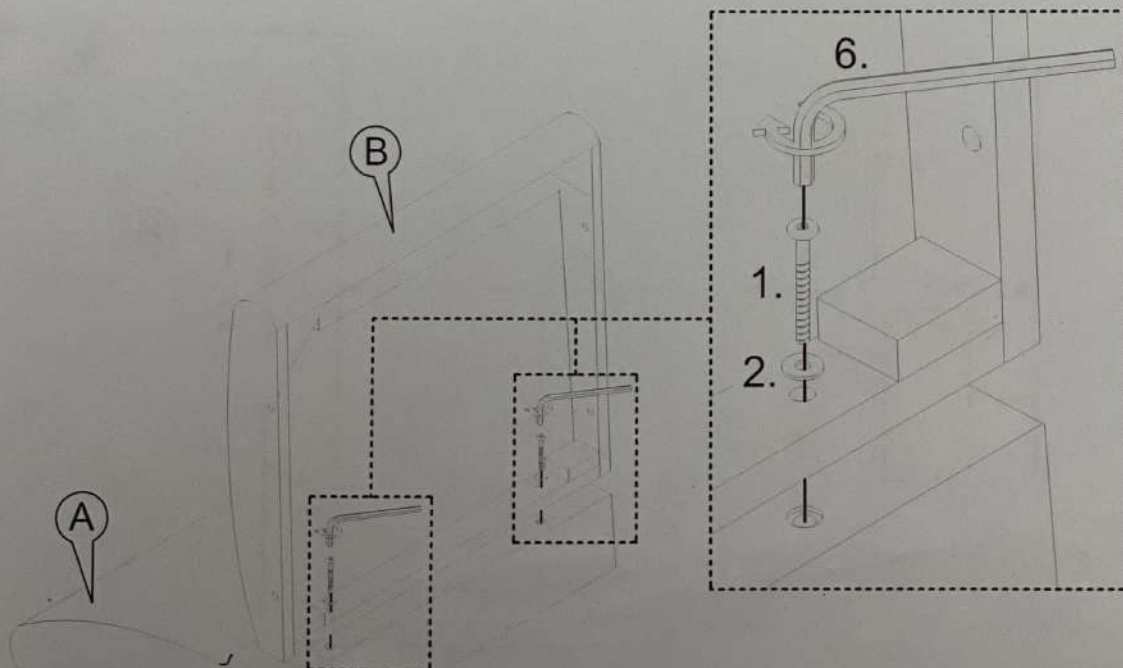

- A.  Cushion Back
- B.  Cushion Seat
- C.  Arm (L/R)
- D.  Support Rail
- E.

STEP 2



F.

HARDWARE

- 1.  JBBC M6 X 40MM
- 2.  Flat Washer M6
- 3.  JBBC M6 X 70MM
- 4.  Spring Washer M6
- 5.  08mm x 30mm Wood Dowel
- 6.  Allen Key M4
- 7.

ASSEMBLY TIPS : Remove hardware from box and sort by size. Check that all hardware and parts are present assembling. Following instruction below in proper sequence to ensure fast, easy correct ass

WARNING! : DO NOT FULLY TIGHTEN ALL BOLTS UNTIL ALL PARTS IN PLACE. FAILURE TO FOLL THIS INSTRUCTION MAY CAUSE THE BOLTS TO BE MISALIGNED DURING THE ASSE

STEP 4 ~~4~~ 3

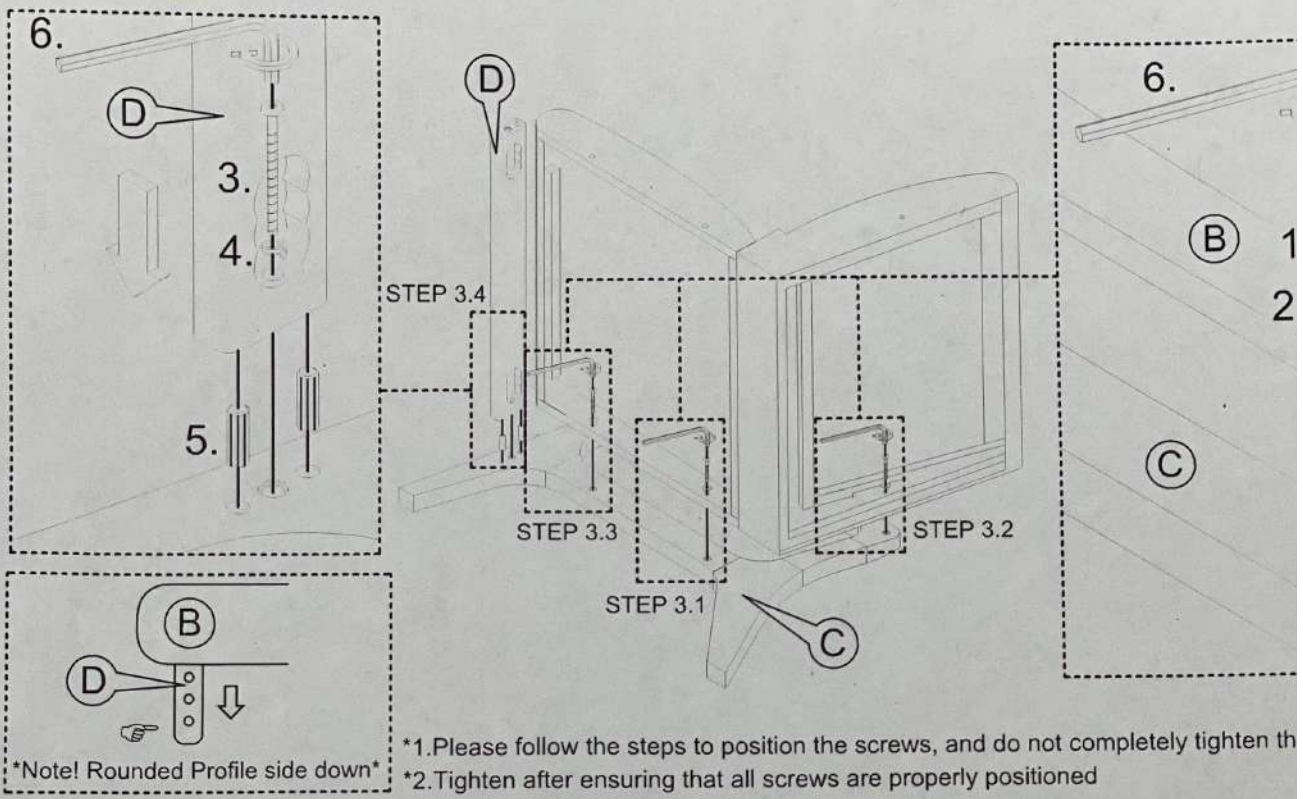

STEP 4

