

MODEL : CANNES UPHOLSTERED BED HEAD AND FRANKI WOODEN BED BASE - KING BED

Thank you for purchasing our product!

Before you start , here is some helpful advice :

1. We suggest you spend a short time reading through this leaflet and then follow the simple step by step instructions.
2. Owing to the size and weight of the product, we recommend that is assembled by two adults, on a carpeted or padded area, in the room that it is intended for . Approximate assembly time: 30 minutes.
3. Please do not use any tools other than those provided or recommend in these instruction.
4. Please do not throw away any of the packaging or instructions until you have checked all the components and hardware and the furniture is fully assembled.
5. Assemble all components loosely until advised to tighten. Depending on use it may be necessary to tighten the components from time to time, so please save the tools that have been provided.
6. Please keep all pieces out of reach of small children.

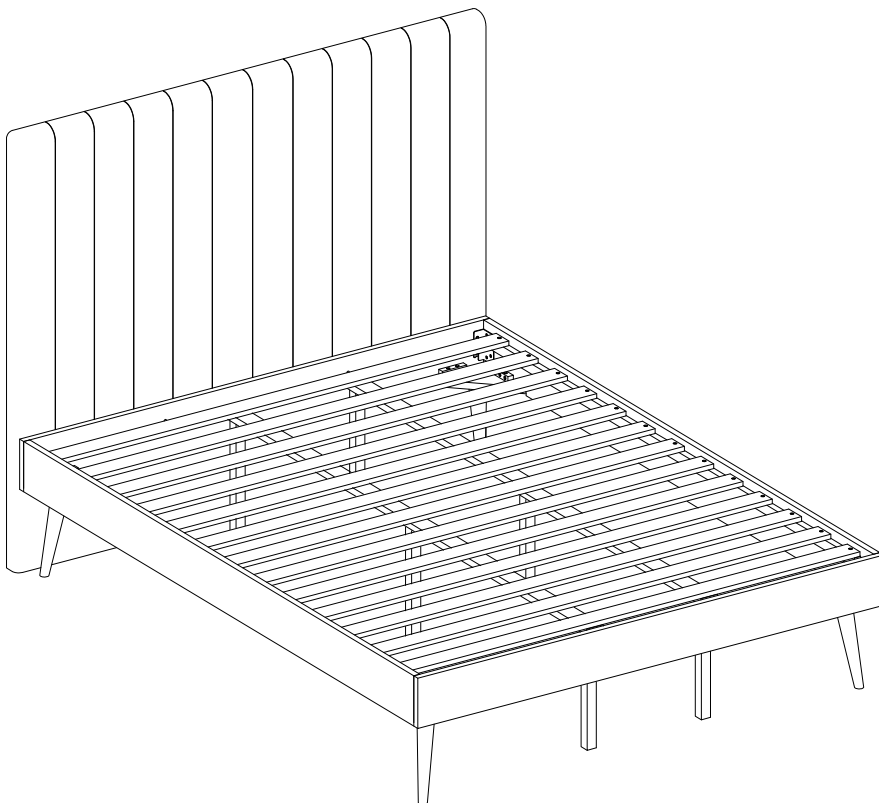

ASSEMBLY COMPLETED



Please ensure the furniture rests on an even and flat surface. If the product wobbles or feels loose, double-check all bolts and/or screws are properly tightened and secured.



Keep this handy!

Please retain this instruction manual and any order-related information for future reference.



**2 - Persons
Recommended**

Parts supplied for assembly

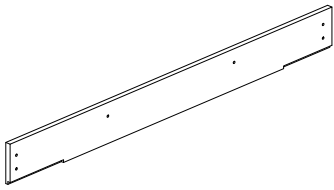

Head Panel
A X 1 Piece

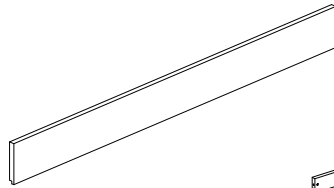

Foot Panel
B X 1 Piece

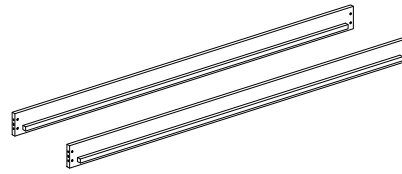

Side Rail
C X 2 Pieces

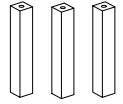

Support Leg
D X 6 Pieces

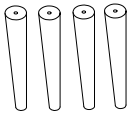

Leg
E X 4 Pieces

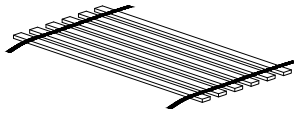

Slat
F X 1 Piece

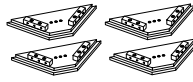

Corner Plate
G X 4 Pieces

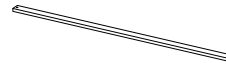

Center Slat
H X 2 Pieces

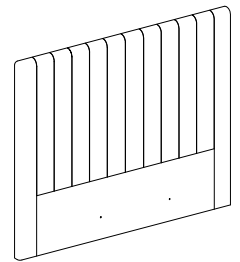

Head Board
I X 1 Piece

Hardware supplied for assembly



M4 x 32 Screw
1 X 58 Pieces

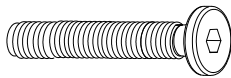

JCBC M8 x 50
2 X 4 Pieces

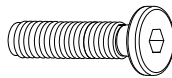

JCBC M8 x 20
3 X 8 Pieces

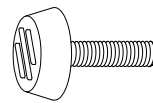

Adjuster
4 X 6 Pieces



JCBC M6 x 60
5 X 6 Pieces



M8 Flat Washer
6 X 12 Pieces



M8 Spring Washer
7 X 12 Pieces

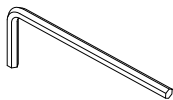

M4 Allen Wrench
8 X 1 Piece

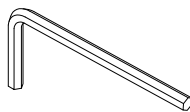

M5 Allen Wrench
9 X 1 Piece



M6 Flat Washer
10 X 2 Pieces



M6 Spring Washer
11 X 2 Pieces

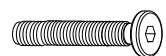

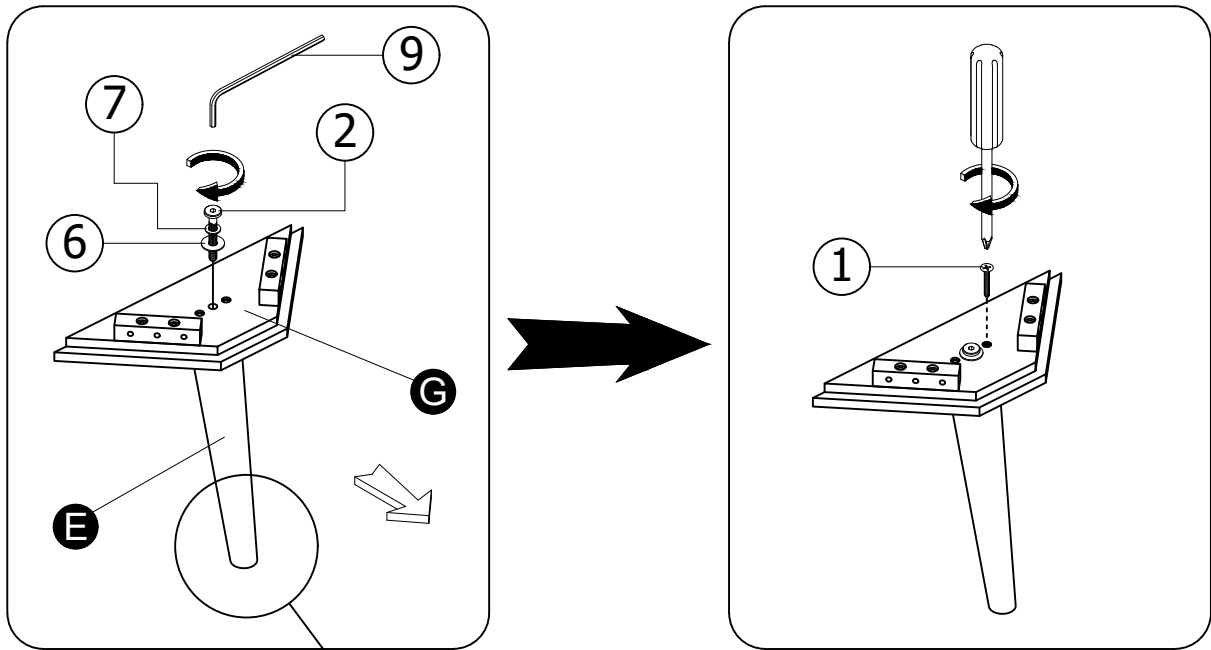

JCBC M6 x 80
12 X 2 Pieces

STEP 1





The LEG must be turn to the right position.

				
② X 4 Pieces	⑥ X 4 Pieces	⑦ X 4 Pieces	⑨ X 1 Piece	① X 8 Pieces

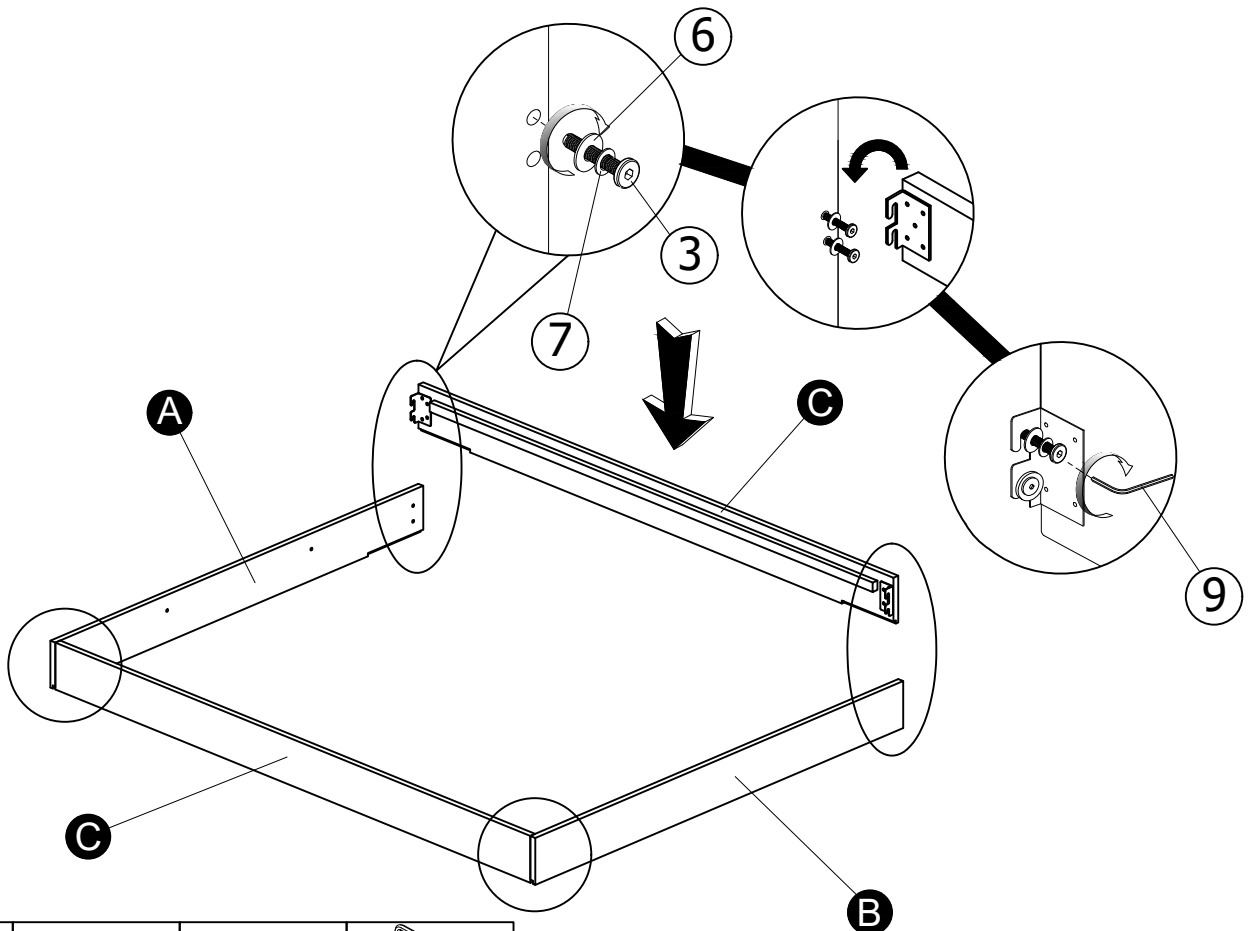
STEP 2



			
③ X 8 Pieces	⑥ X 8 Pieces	⑦ X 8 Pieces	⑨ X 1 Piece

STEP 3

BOX

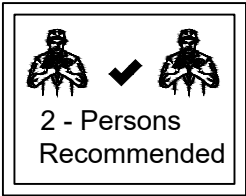

BOX

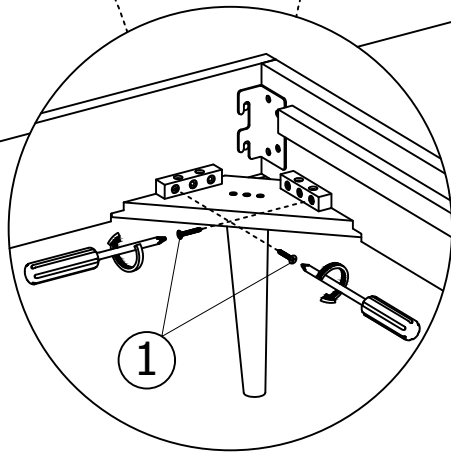
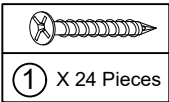

STEP 4

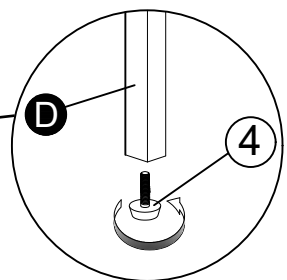
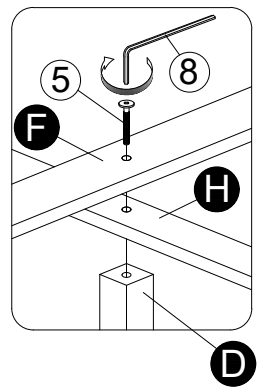
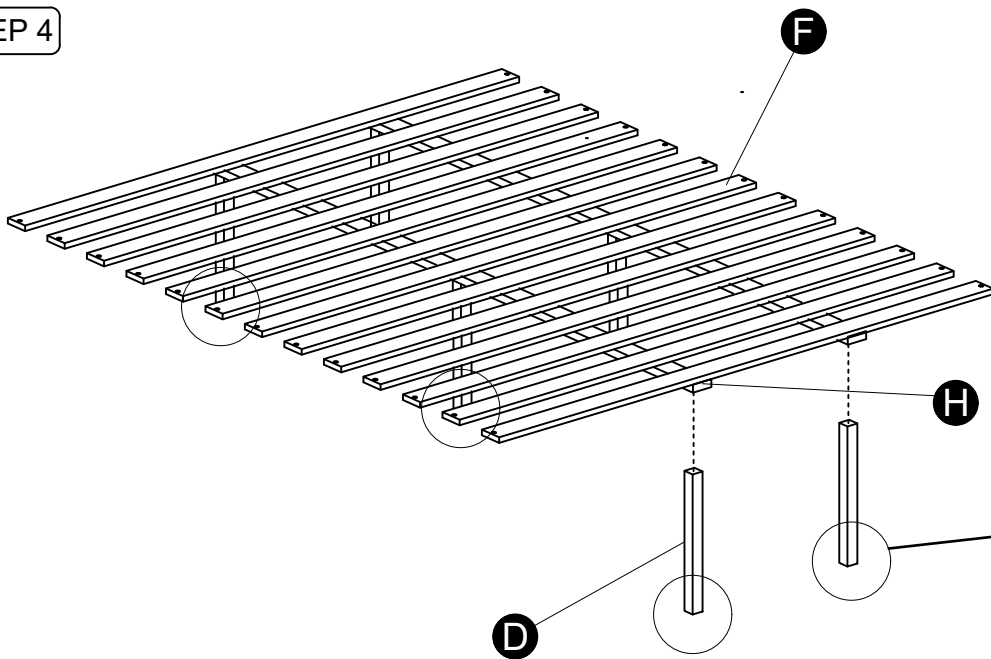

5 X 6 Pieces	4 X 6 Pieces	8 X 1 Piece

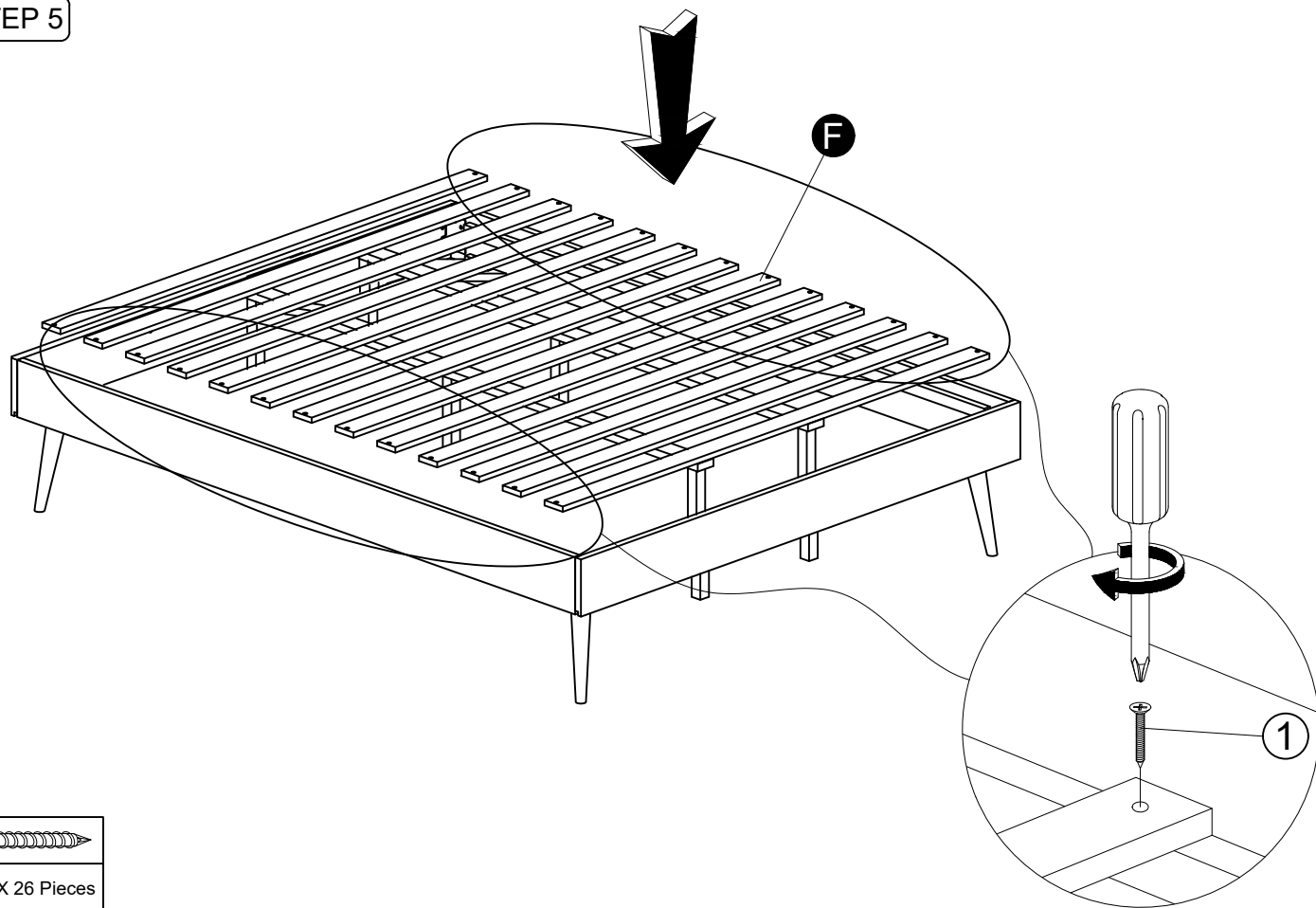

Support legs should have approx 1cm of space from the floor when installed. Please note! If support legs are in contact with the floor when the bed is not in use they can prevent the slats from functioning as intended as well as risk damage to the frame

STEP 5

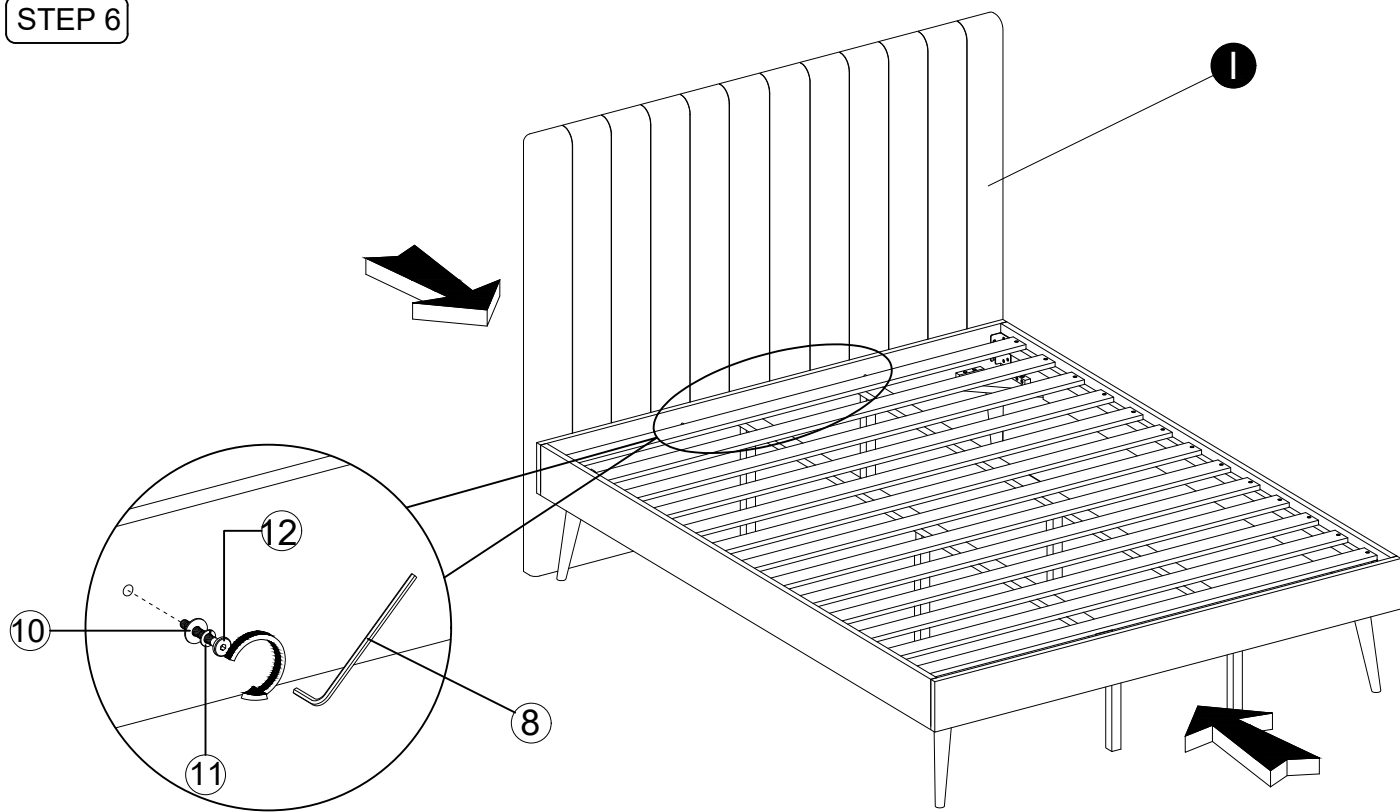

STEP 6



			
12 X 2 Pieces	10 X 2 Pieces	11 X 2 Pieces	8 X 1 Piece