

ASSEMBLY INSTRUCTIONS

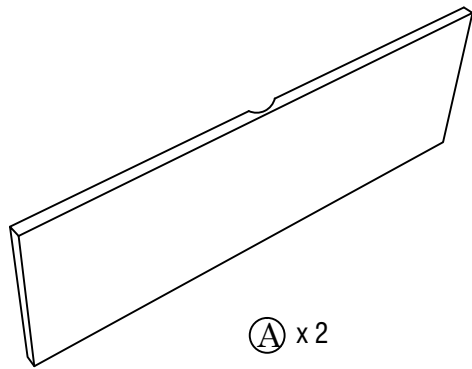

Ⓐ x 2

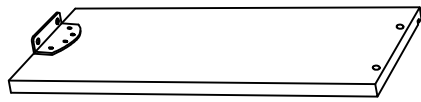

Ⓑ x 4



Ⓒ x 2





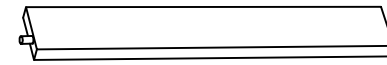

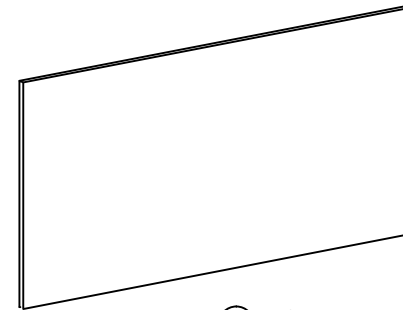

Ⓓ x 2



Ⓔ x 4

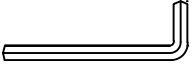
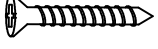

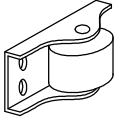
Ⓕ x 2

1.	x 8	2.	x 8	3.	x 1	4.	x 8	5.	x 8	6.	x 8	7.	x 32
													
M6 x 16mm		M6 x 60mm		ALLEN KEY		M7 x 40mm		M6 x 13mm		WHEEL		M4 x 16mm	

ASSEMBLY INSTRUCTIONS

