

B2C FURNITURE

ASSEMBLY INSTRUCTIONS

AXEL-MAIN SHELVING UNIT - TALL (1850 x 800mm)

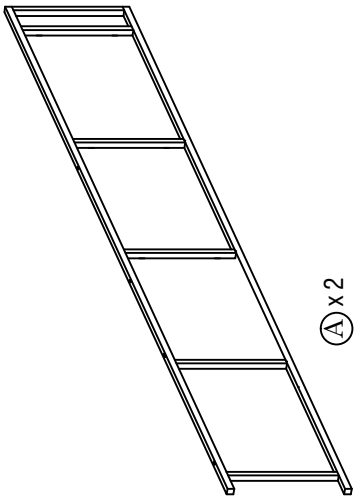



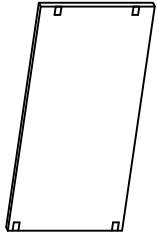









A x 2

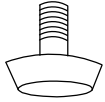

B x 5





C x 4

1.	 JCBC M6 x 20mm	x 8	2.	 JCBC M6 x 16mm	x 2	3.	 JCN NUT M6 x 15mm	x 8	4.	 M6 HEX NUT	x 2	5.	 PAN HEAD SCREW M4 x 30mm	x 2	6.	 PAN HEAD SCREW M3.5 x 16mm	x 42
7.	 ADJUSTER SCREW	x 4	8.	 U BRACKET	x 20	9.	 5003 L BRACKET	x 2	10.	 PLUG	x 2	11.	 ALLEN KEY WITH BALL	x 1	12.	 Plastic	x 4

AXEL-MAIN SHELVING UNIT - TALL (1850 x 800mm)

1

- 7.  x 4
ADJUSTER SCREW
- 12.  x 4
Plastic

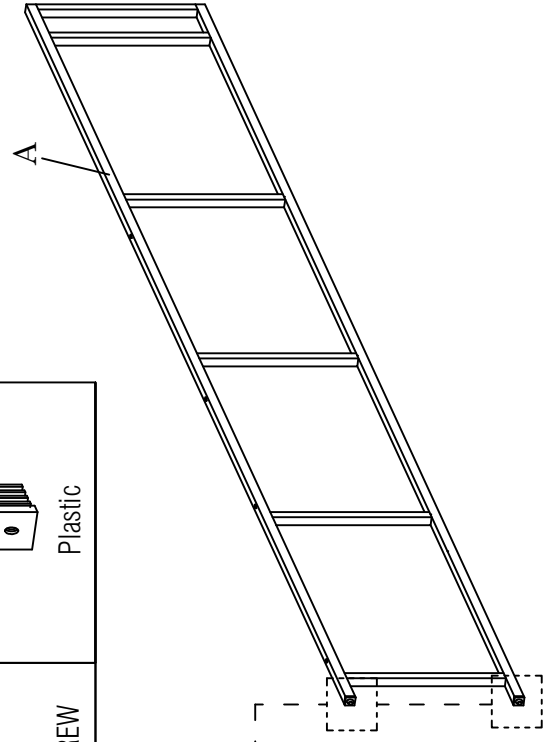
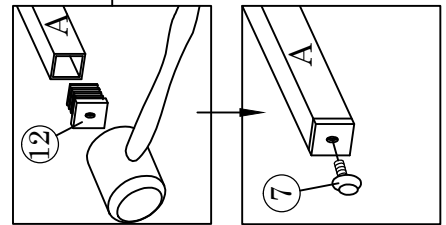

2

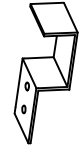
- 6.  x 40
PAN HEAD SCREW
M3.5 x 16mm
- 8.  x 20

Please follow marking lines on Part B to screw in U Brackets.

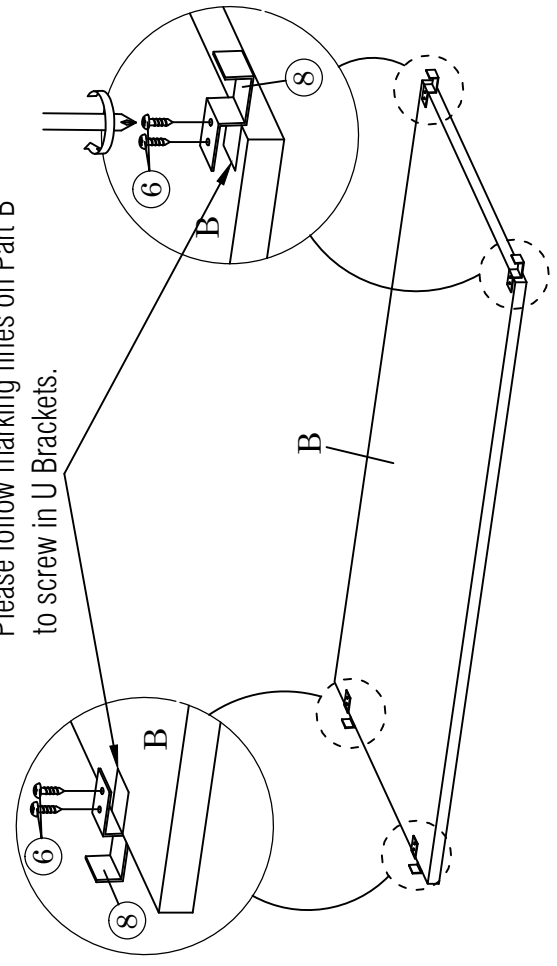



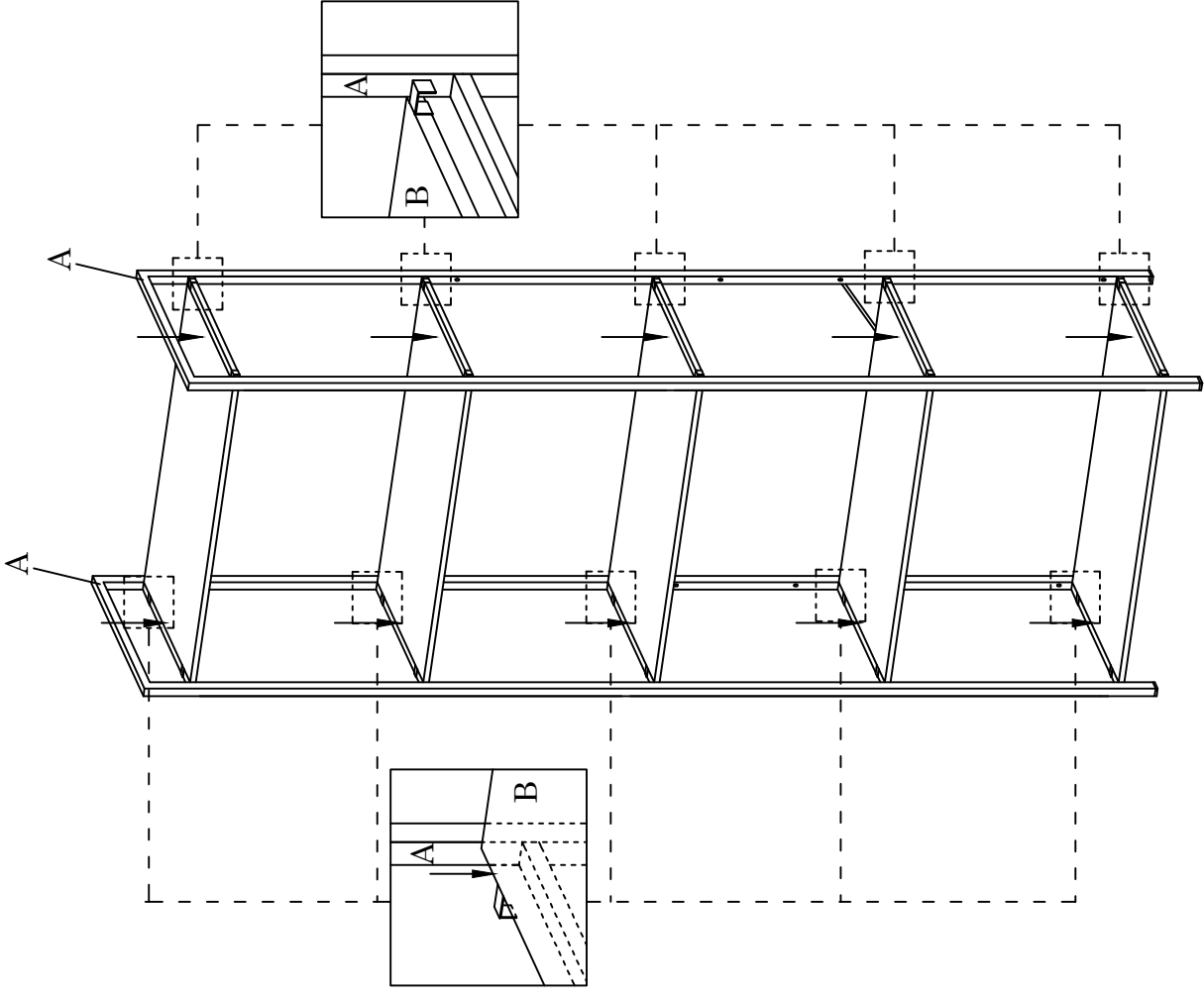

3

*Please make sure the u bracket hang in the same position.



AXEL-MAIN SHELVING UNIT - TALL (1850 x 800mm)

4

1.  x 8	2.  x 2	3.  x 8
JCBC M6 x 20mm	JCBC M6 x 16mm	JCN NUT M6 x 15mm
	4.  x 2	11.  x 1
	M6 HEX NUT	ALLEN KEY WITH BALL



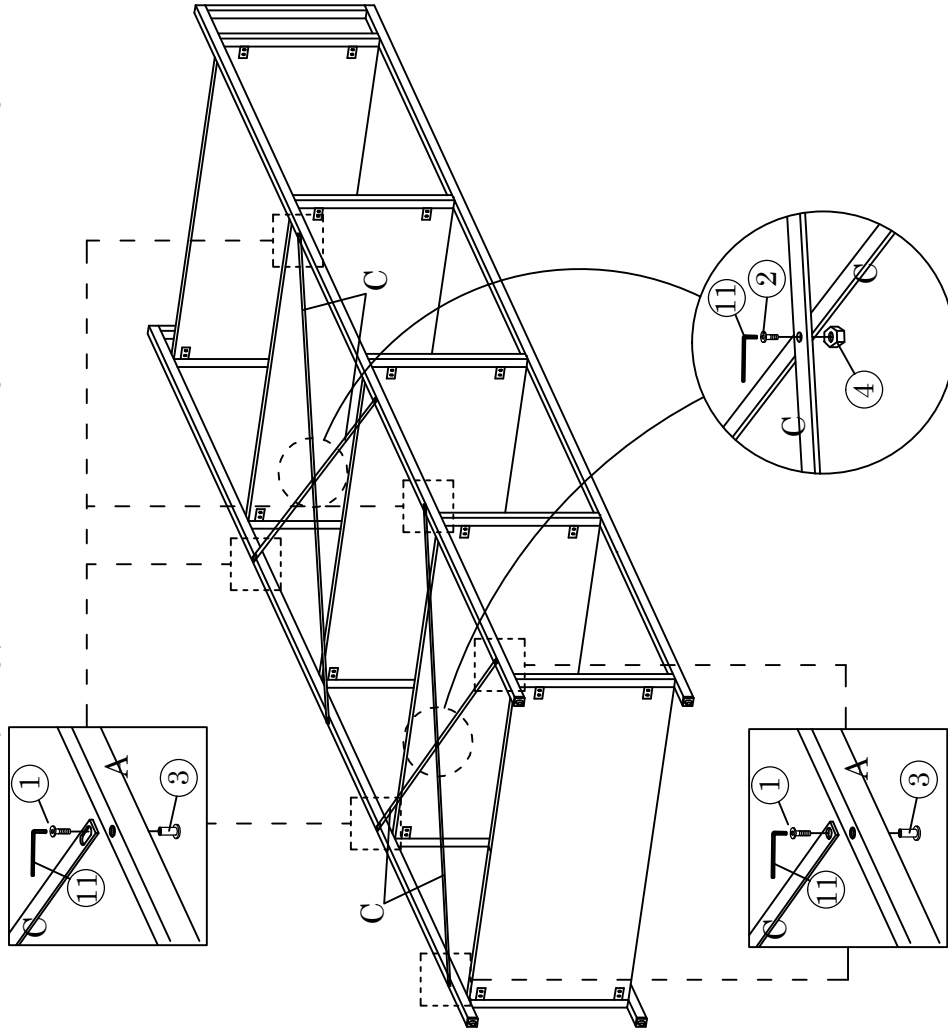

*Adjusting part A will assist to align holes before screwing.

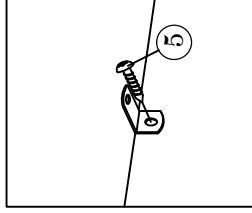
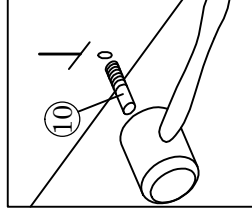
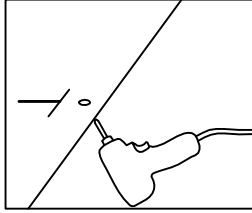
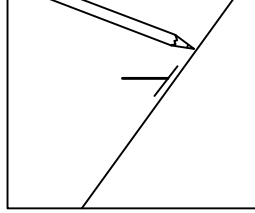
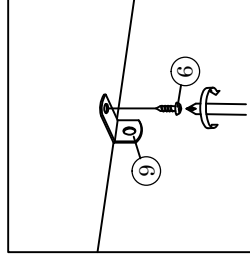

*Adjusting part A will assist to align holes before screwing.

5



5.  x 2	6.  x 2
PAN HEAD SCREW M4 x 30mm	PAN HEAD SCREW M3.5 x 16mm
9.  x 2	10.  x 2
5003 L BRACKET	PLUG

