

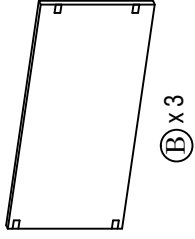

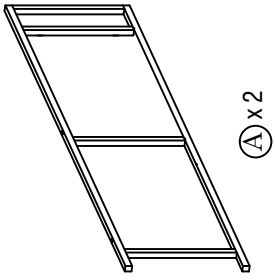





B2C FURNITURE

ASSEMBLY INSTRUCTIONS



AXEL-MAIN SHELVING UNIT - SHORT (1005 x 800mm)

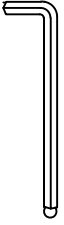

1.	x4	JCBC M6 x 20mm 	x1	x1	x2	x26					
2.	x4	JCBC M6 x 16mm 	3.	JCN NUT M6 x 15mm 	4.	PAN HEAD SCREW M4 x 30mm 	5.	PAN HEAD SCREW M3.5 x 16mm 	6.	12.	x4
7.	x4	ADJUSTER SCREW 	8.	U BRACKET 	9.	5003 L BRACKET 	10.	ALLEN KEY WITH BALL 	11.	11.	x1
											Plastic

AXEL-MAIN SHELVING UNIT - SHORT (1005 x 800mm)

1

- 7.  x 4
ADJUSTER SCREW
-  x 4
Plastic

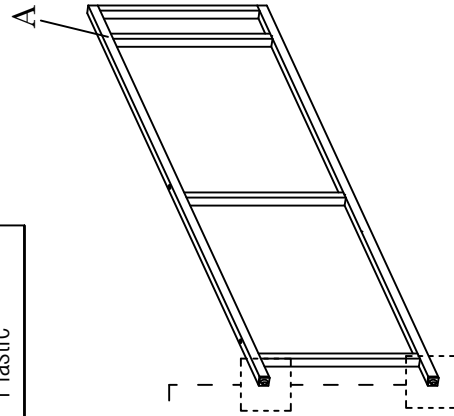
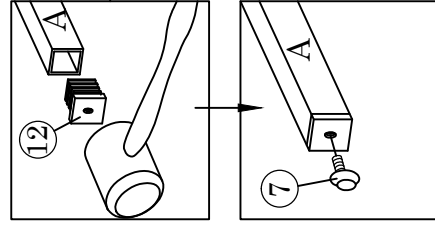

3

*Please make sure the u bracket hang in the same position.

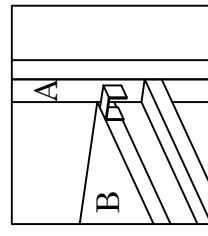
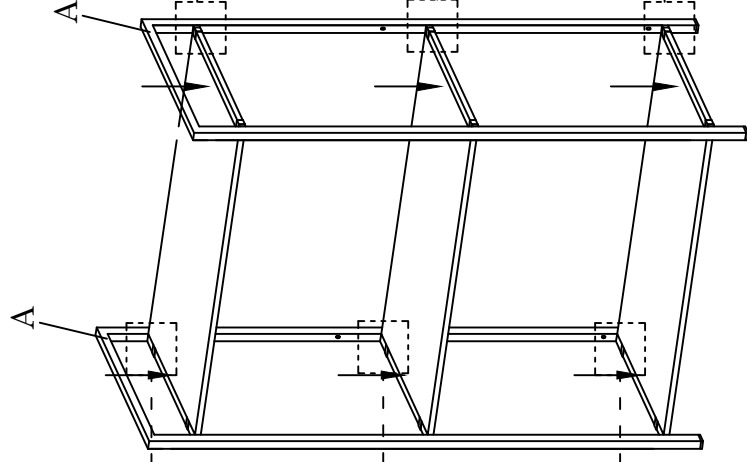
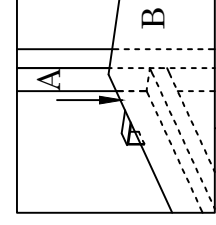

2

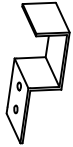

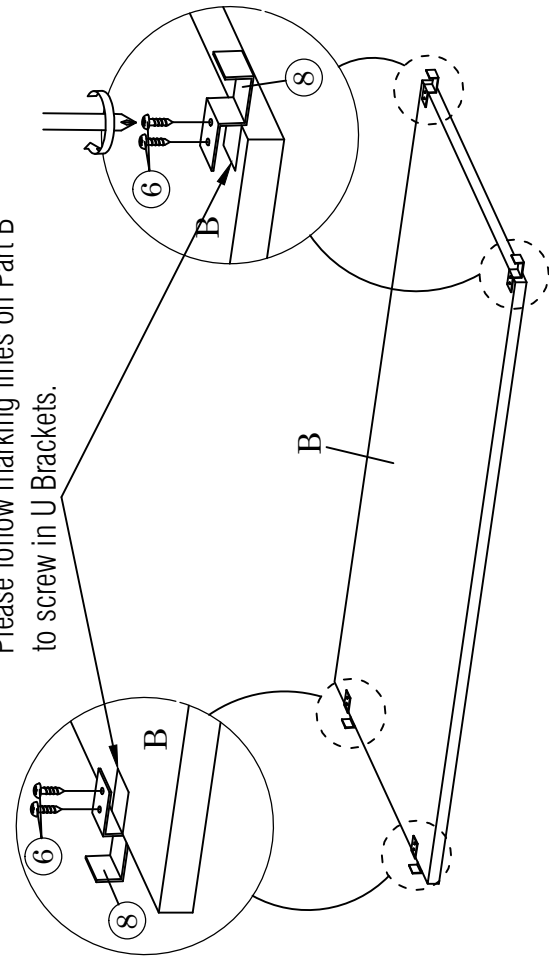

- 6.  x 24 8.  x 12
PAN HEAD SCREW
M3.5 x 16mm

Please follow marking lines on Part B to screw in U Brackets.



AXEL-MAIN SHELVING UNIT - SHORT (1005 x 800mm)

4

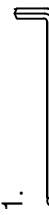

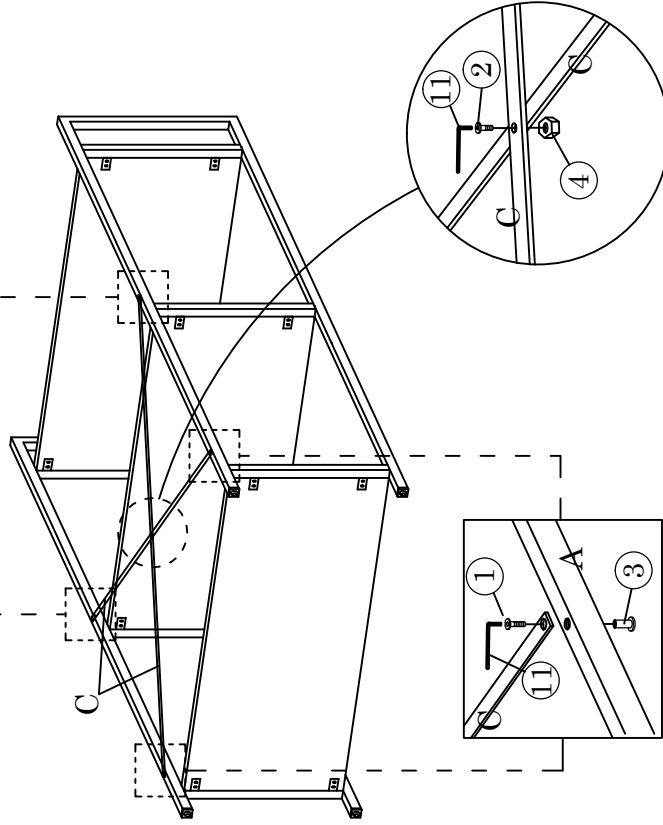
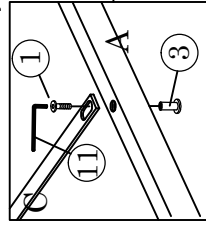

1.  x4	2.  x1	3.  x4
JCBC M6 x 20mm	JCBC M6 x 16mm	JCN NUT M6 x 15mm
	4.  x1	11.  x1
	M6 HEX NUT	ALLEN KEY WITH BALL

*Adjusting part A will assist to align holes before screwing



*Adjusting part A will assist to align holes before screwing.

5

5.  x2	6.  x2
PAN HEAD SCREW M4 x 30mm	PAN HEAD SCREW M3.5 x 16mm
9.  x2	10.  x2
5003 L BRACKET	PLUG

