

# B2C FURNITURE

## ASSEMBLY INSTRUCTIONS

AXEL-MAIN SHELVING UNIT - MEDIUM (1430 x 800mm)

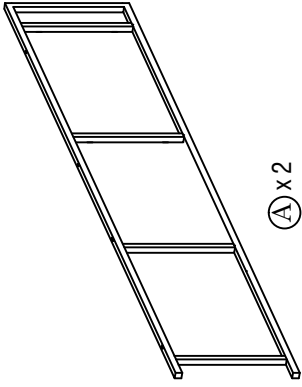



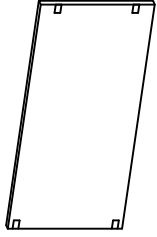









A x 2

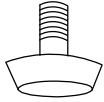

B x 4



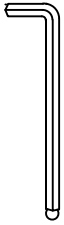

C x 4

1.	 JCBC M6 x 20mm x 8	 JCBC M6 x 16mm x 2	 JCN NUT M6 x 15mm x 8	 M6 HEX NUT x 2	 PAN HEAD SCREW M4 x 30mm x 2	 PAN HEAD SCREW M3.5 x 16mm x 34
7.	 ADJUSTER SCREW x 4	 U BRACKET x 16	 5003 L BRACKET x 2	 PLUG x 2	 ALLEN KEY WITH BALL x 1	 Plastic x 4

# AXEL-MAIN SHELVING UNIT - MEDIUM (1430 x 800mm)

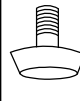
1

7.	x 4	x 4
	ADJUSTER SCREW	
		Plastic

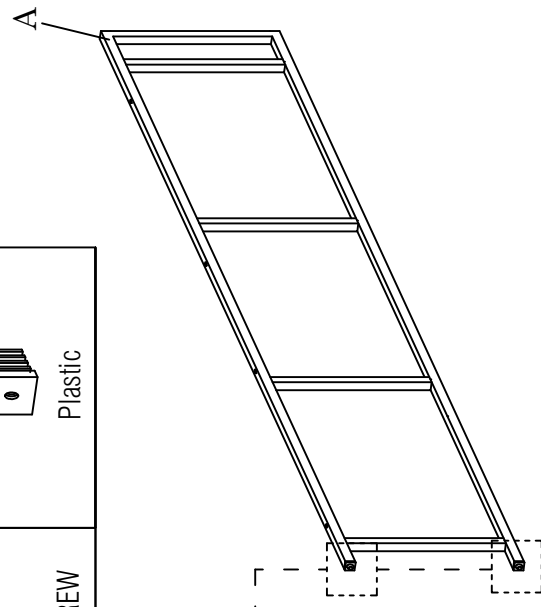
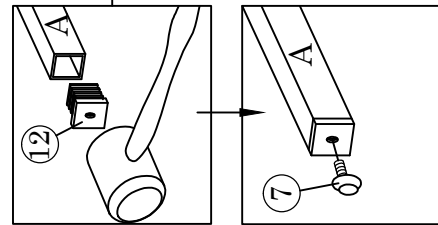

2

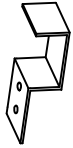
6.	x 32	8.	x 16
			
PAN HEAD SCREW M3.5 x 16mm			

Please follow marking lines on Part B to screw in U Brackets.

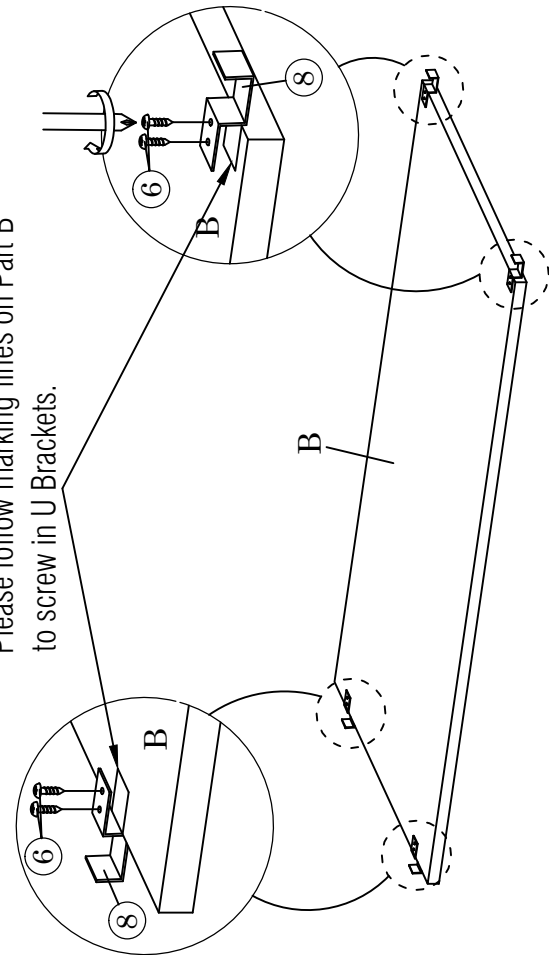



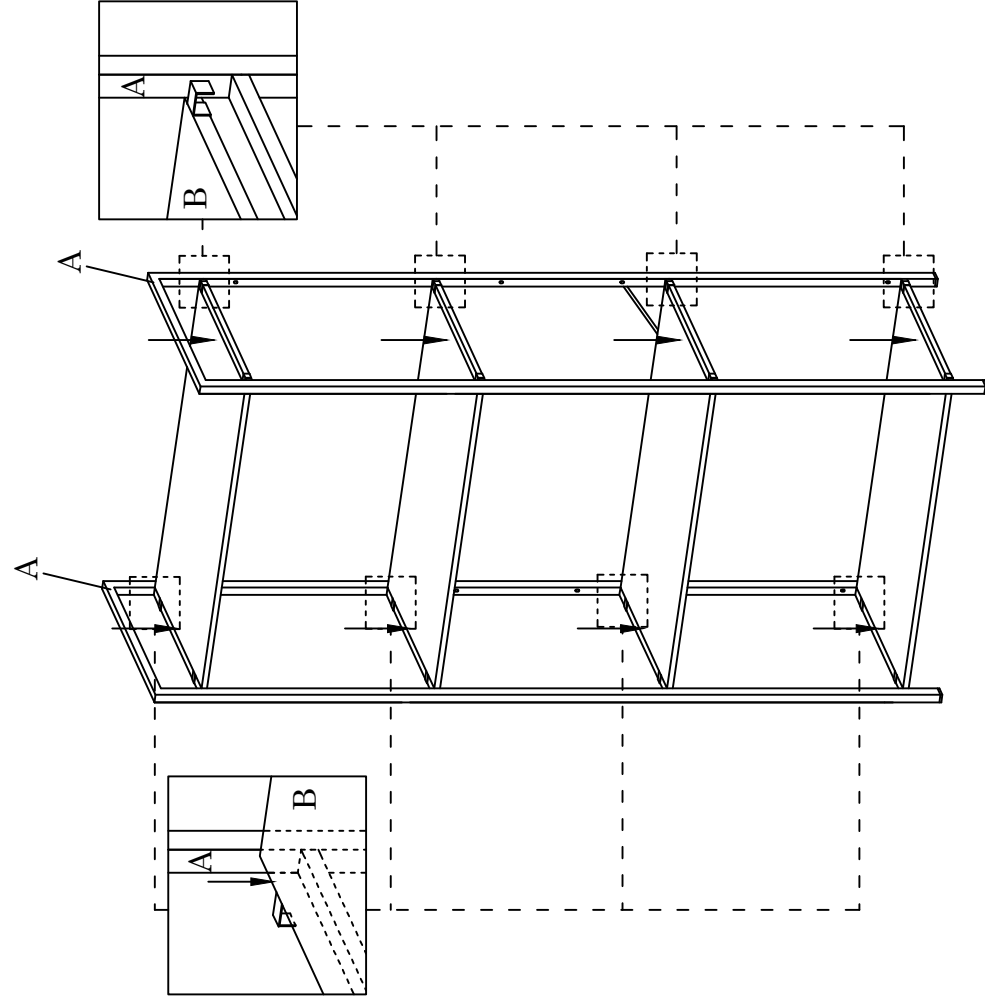

3

\*Please make sure the u bracket hang in the same position.



# AXEL-MAIN SHELVING UNIT - MEDIUM (1430 x 800mm)

4

1.  x 8	2.  x 2	3.  x 8
JCBC M6 x 20mm	JCBC M6 x 16mm	JCN NUT M6 x 15mm
	4.  x 2	11.  x 1
	M6 HEX NUT	ALLEN KEY WITH BALL



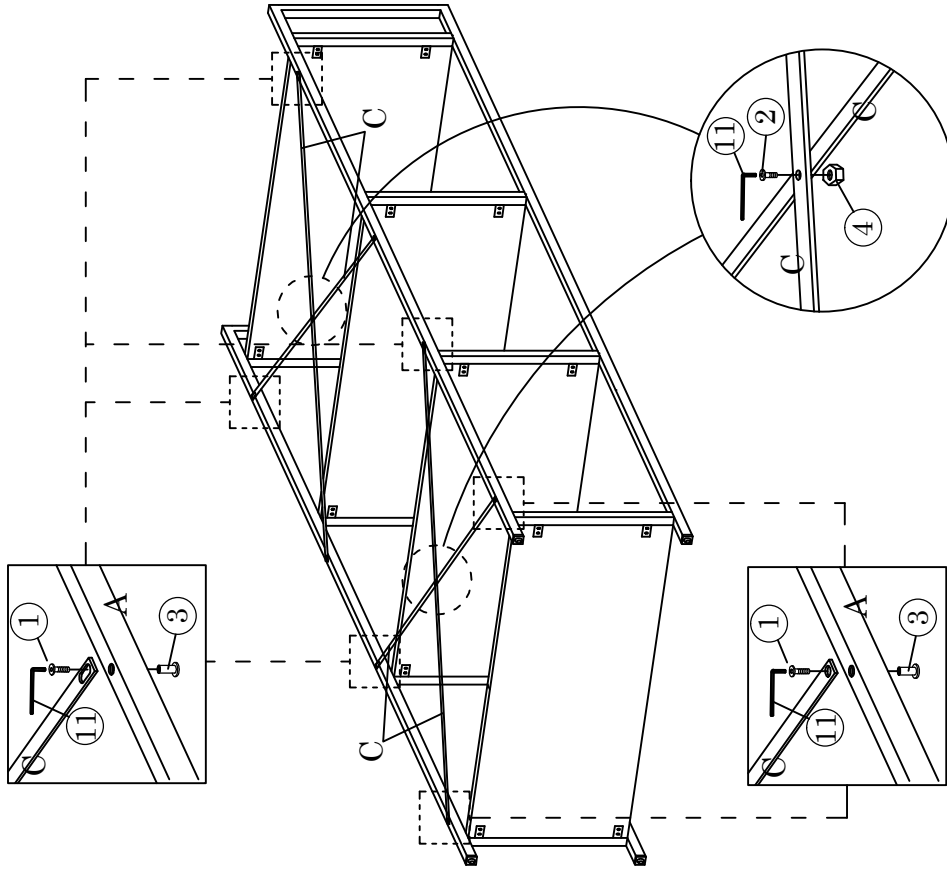

\* Adjusting part A will assist to align holes before screwing.

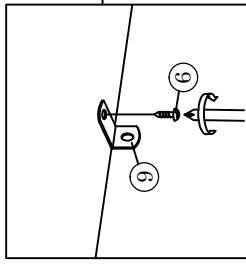

\* Adjusting part A will assist to align holes before screwing.

5



5.  x 2	6.  x 2
PAN HEAD SCREW M4 x 30mm	PAN HEAD SCREW M3.5 x 16mm
9.  x 2	10.  x 2
5003 L BRACKET	PLUG

