

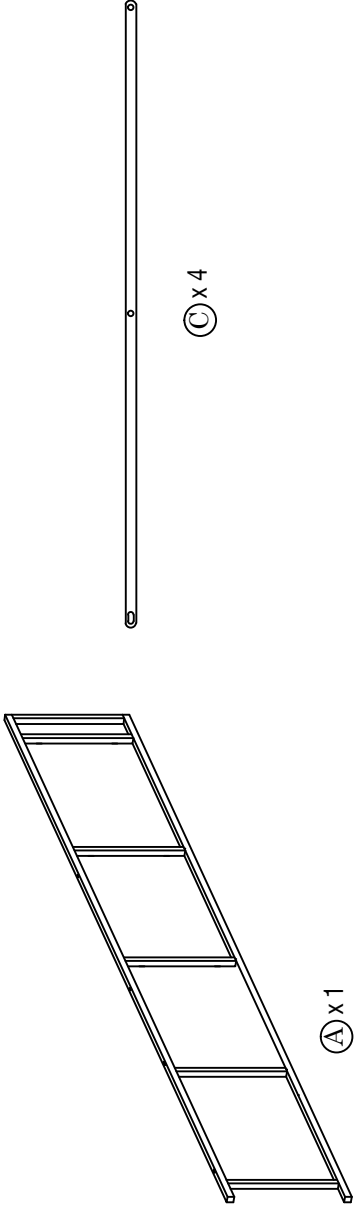











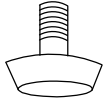





B2C FURNITURE

ASSEMBLY INSTRUCTIONS



AXEL-EXTENSION SHELVING UNIT - TALL (1850 x 800mm)



1.	x4	 JCBC M6 x 20mm	x2	 JCN NUT M6 x 15mm	x2	 PAN HEAD SCREW M4 x 30mm	x42	 PAN HEAD SCREW M3.5 x 16mm
7.	x2	 ADJUSTER SCREW	x20	 5003 L BRACKET	x2	 ALLEN KEY WITH BALL	x2	 Plastic
2.	x4	 JCBC M6 x 16mm	x4	 M6 HEX NUT	x2	 U BRACKET	6.	12.
3.	x2	 U BRACKET	x2	 M6 HEX NUT	x2	 ALLEN KEY WITH BALL	11.	
4.	x4	 JCN NUT M6 x 15mm	x2	 5003 L BRACKET	x2			
5.	x2	 PAN HEAD SCREW M4 x 30mm	x2	 ALLEN KEY WITH BALL	x1			

AXEL-EXTENSION SHELVING UNIT - TALL (1850 x 800mm)

1

- 7.  x 2
- 12.  x 2
- Plastic

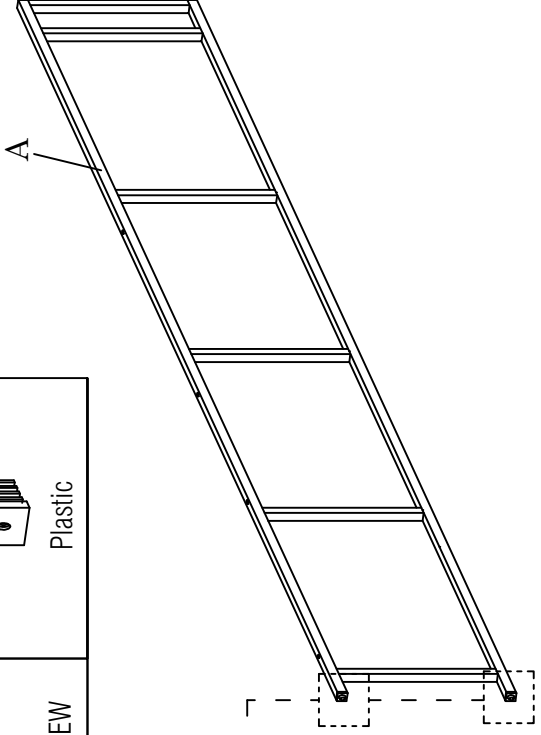
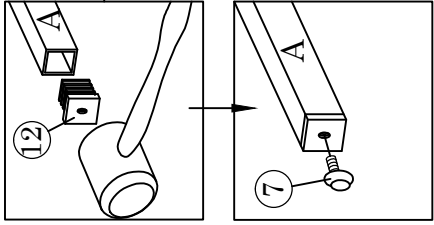

2

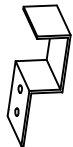
- 6.  x 40 | 8.  x 20
- PAN HEAD SCREW
M3.5 x 16mm

Please follow marking lines on Part B to screw in U Brackets.

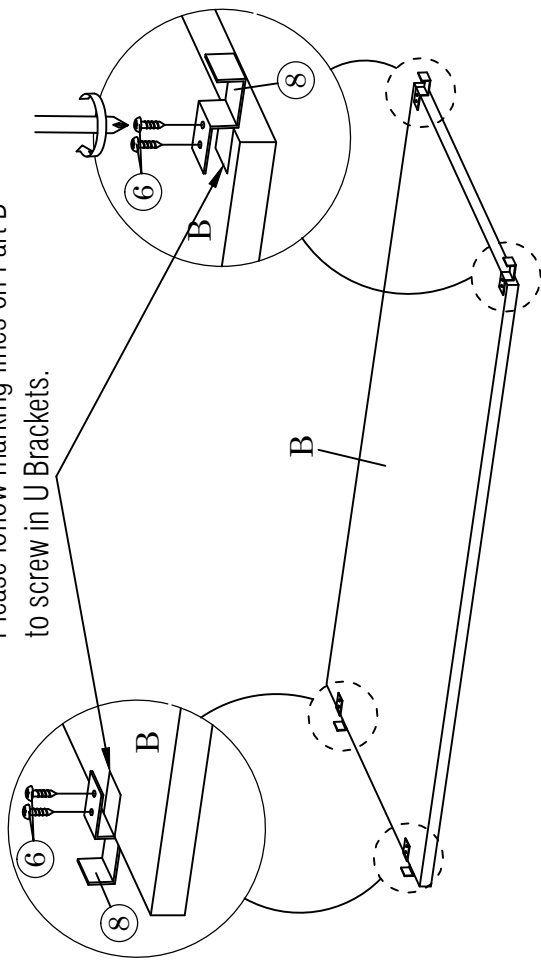

3



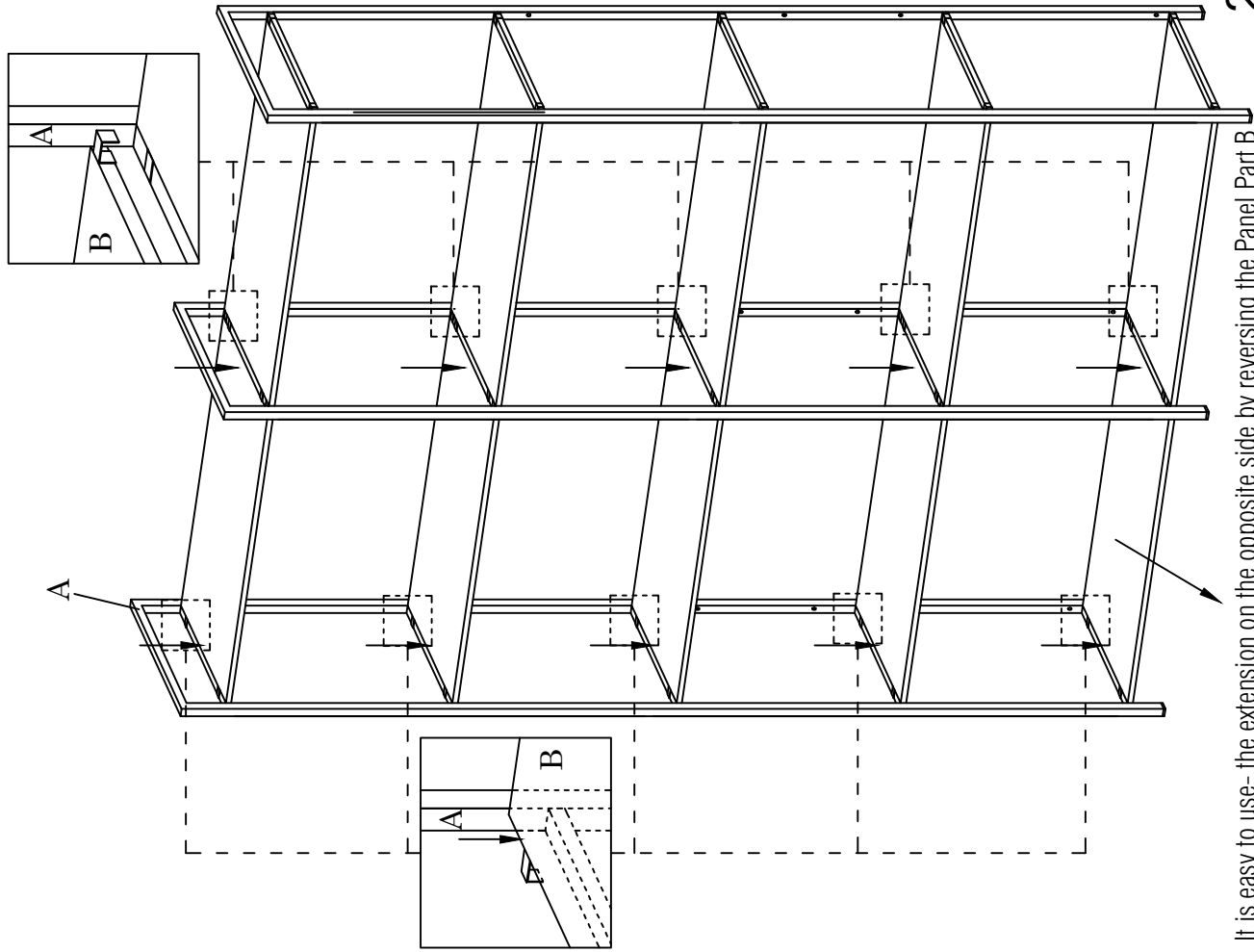

* Please make sure the u bracket hang in the same position.



It is easy to use- the extension on the opposite side by reversing the Panel Part B

AXEL-EXTENSION SHELVING UNIT - TALL (1850 x 800mm)

4

1.  x 4	2.  x 2	3.  x 4
JCBC M6 x 20mm	JCBC M6 x 16mm	JCN NUT M6 x 15mm
	4.  x 2	11.  x 1
	M6 HEX NUT	ALLEN KEY WITH BALL



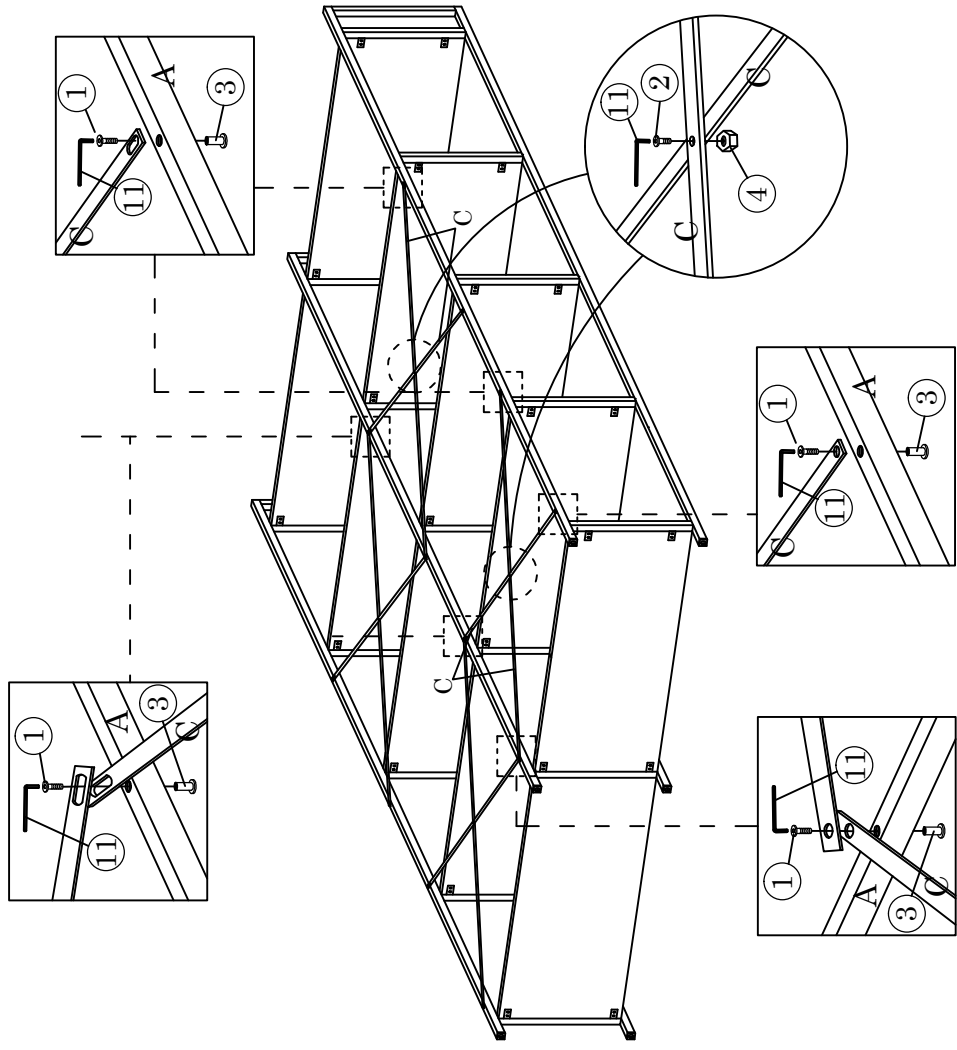

* Adjusting part A will assist to align holes before screwing.

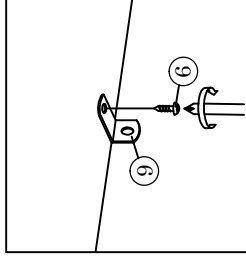

* Adjusting part A will assist to align holes before screwing.

5



5.  x 2	6.  x 2
PAN HEAD SCREW M4 x 30mm	PAN HEAD SCREW M3.5 x 16mm
9.  x 2	10.  x 2
5003 L BRACKET	PLUG

