

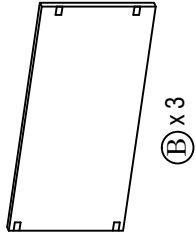

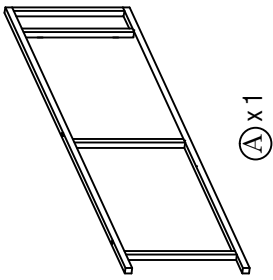









B2C FURNITURE

ASSEMBLY INSTRUCTIONS

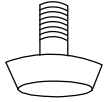
AXEL-EXTENSION SHELVING UNIT - SHORT (1005 x 800mm)



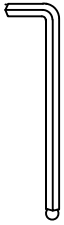

C x2

1.	x2	JCBC M6 x 20mm 	2.	x1	JCBC M6 x 16mm 	3.	x2	JCN NUT M6 x 15mm 	4.	x1	M6 HEX NUT 	5.	x2	PAN HEAD SCREW M4 x 30mm 	6.	x26	PAN HEAD SCREW M3.5 x 16mm 
7.	x2	ADJUSTER SCREW 	8.	x12	U BRACKET 	9.	x2	5003 L BRACKET 	10.	x2	PLUG 	11.	x1	ALLEN KEY WITH BALL 	12.	x2	Plastic 

AXEL-EXTENSION SHELVING UNIT - SHORT (1005 x 800mm)

1

- 7.  x 2
ADJUSTER SCREW
-  x 2
Plastic

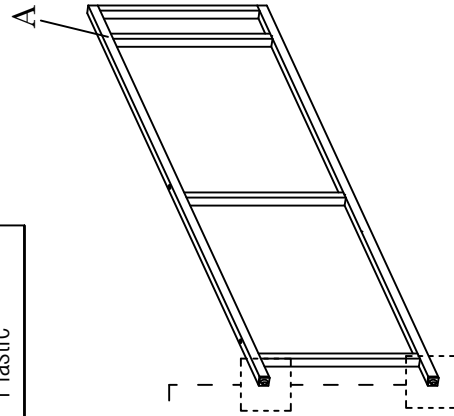
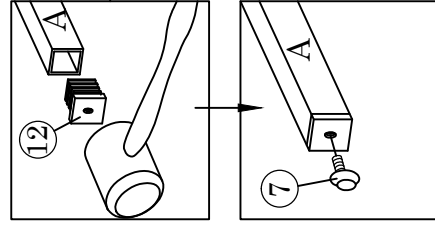

2

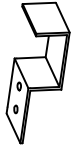
- 6.  x 24
PAN HEAD SCREW
M3.5 x 16mm
- 8.  x 12

Please follow marking lines on Part B to screw in U Brackets.

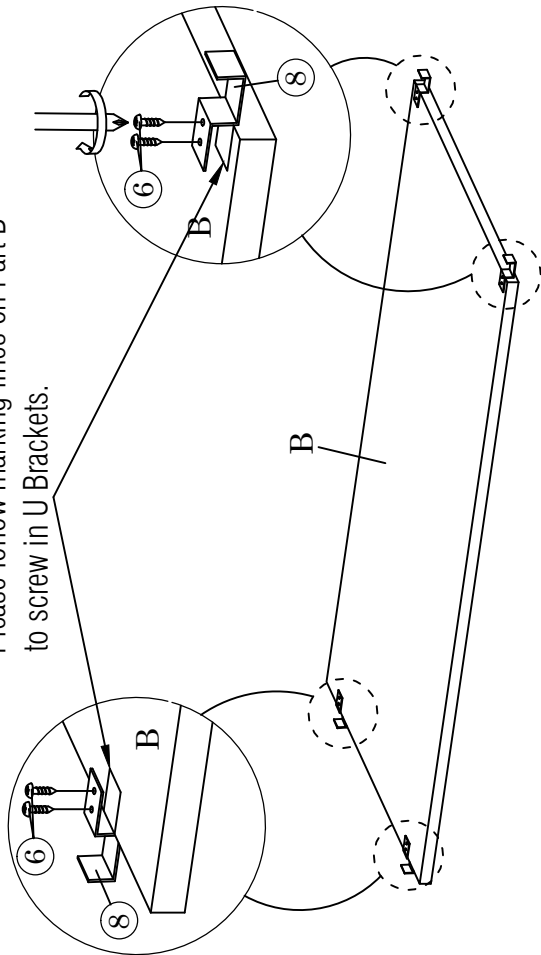

3



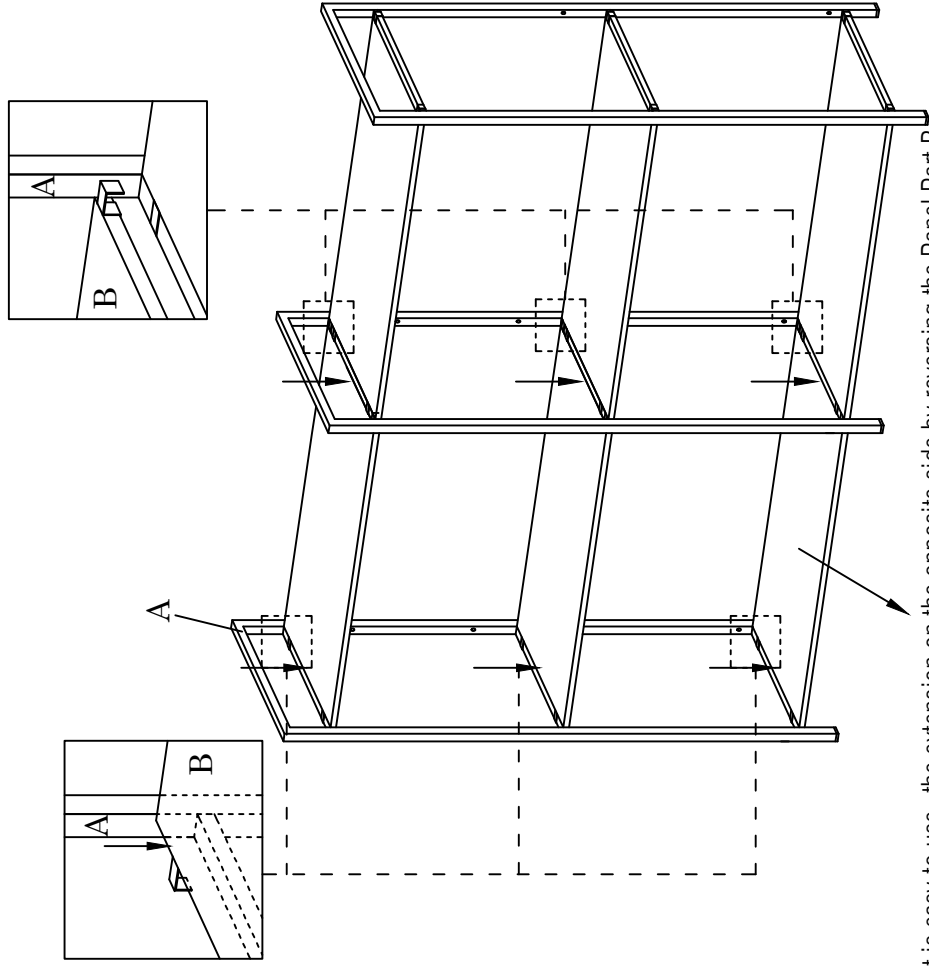

*Please make sure the u bracket hang in the same position.



It is easy to use- the extension on the opposite side by reversing the Panel Part B

AXEL-EXTENSION SHELVING UNIT - SHORT (1005 x 800mm)

4



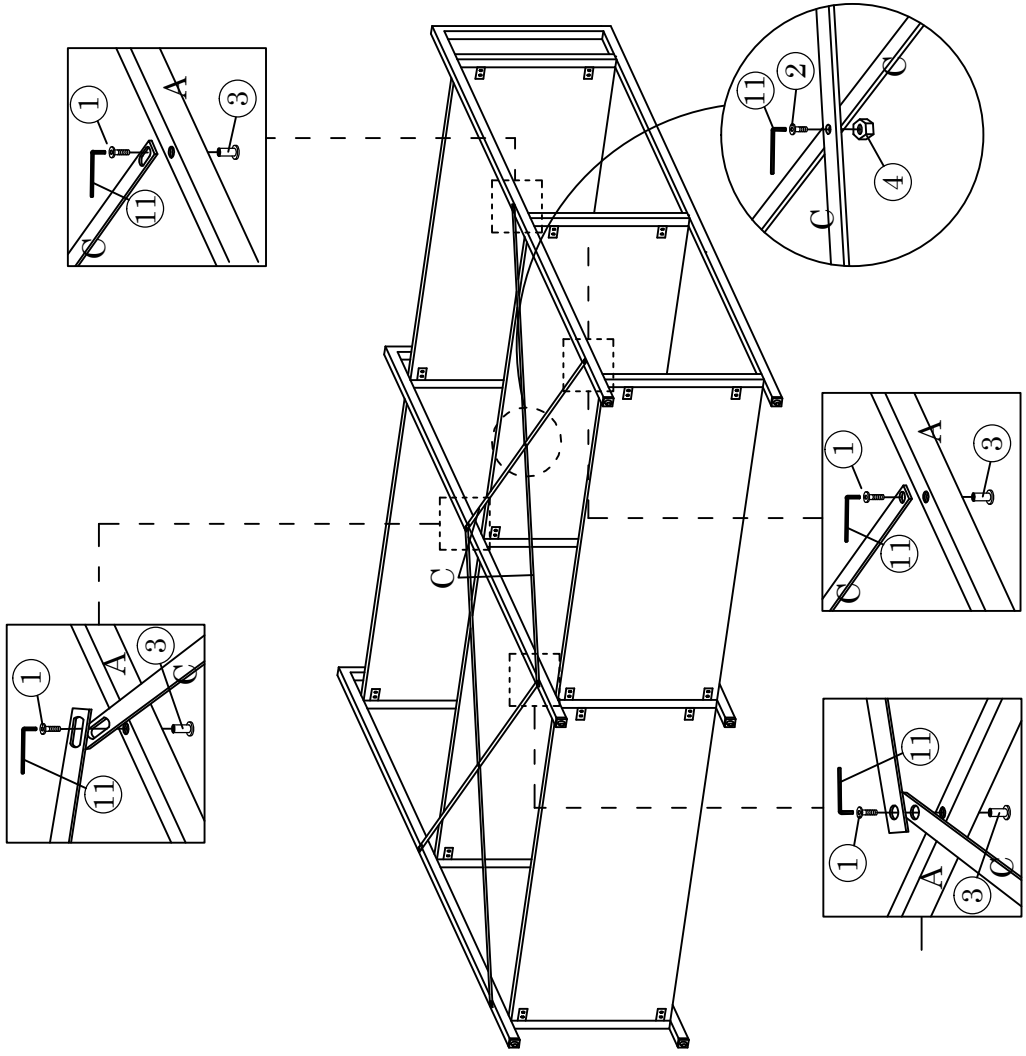

1.  x2	2.  x1	3.  x2
JCBC M6 x 20mm	JCBC M6 x 16mm	JCN NUT M6 x 15mm
4.  x1	11.  x1	
M6 HEX NUT	ALLEN KEY WITH BALL	

*Adjusting part A will assist to align holes before screwing.



*Adjusting part A will assist to align holes before screwing.

5

5.  x2	6.  x2
PAN HEAD SCREW M4 x 30mm	PAN HEAD SCREW M3.5 x 16mm
9.  x2	10.  x2
5003 L BRACKET	PLUG

