

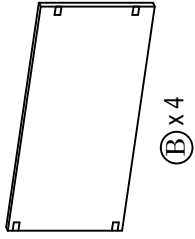

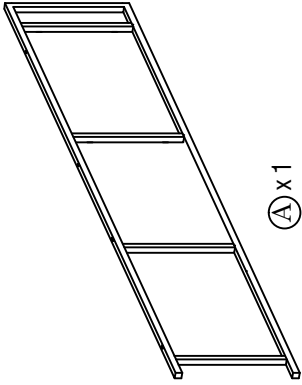







# B2C FURNITURE

## ASSEMBLY INSTRUCTIONS

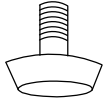

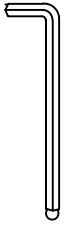
AXEL-EXTENSION SHELVING UNIT - MEDIUM (1430 x 800mm)



1.	x4	 JCBC M6 x 20mm	x2	 JCN NUT M6 x 15mm	x4	4.	 M6 HEX NUT	x2	5.	 PAN HEAD SCREW M4 x 30mm	x2	6.	 PAN HEAD SCREW M3.5 x 16mm	x34
7.	x2	 ADJUSTER SCREW	x16	 5003 L BRACKET	x2	9.	 PLUG	x2	11.	 ALLEN KEY WITH BALL	x1	12.	 Plastic	x2

# AXEL-EXTENSION SHELVING UNIT - MEDIUM (1430 x 800mm)

1

- 7.  x 2
  - 12.  x 2
- ADJUSTER SCREW
- Plastic

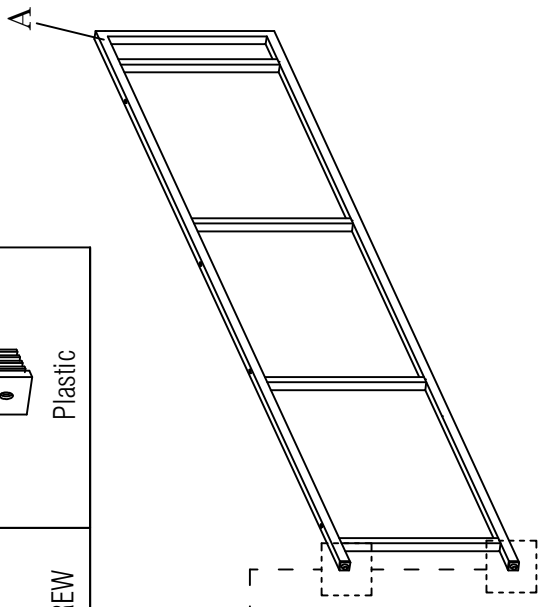
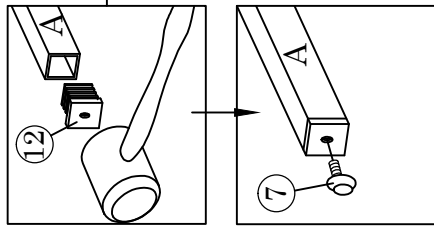

2

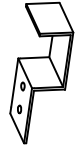
- 6.  x 32
  - 8.  x 16
- PAN HEAD SCREW  
M3.5 x 16mm

Please follow marking lines on Part B to screw in U Brackets.

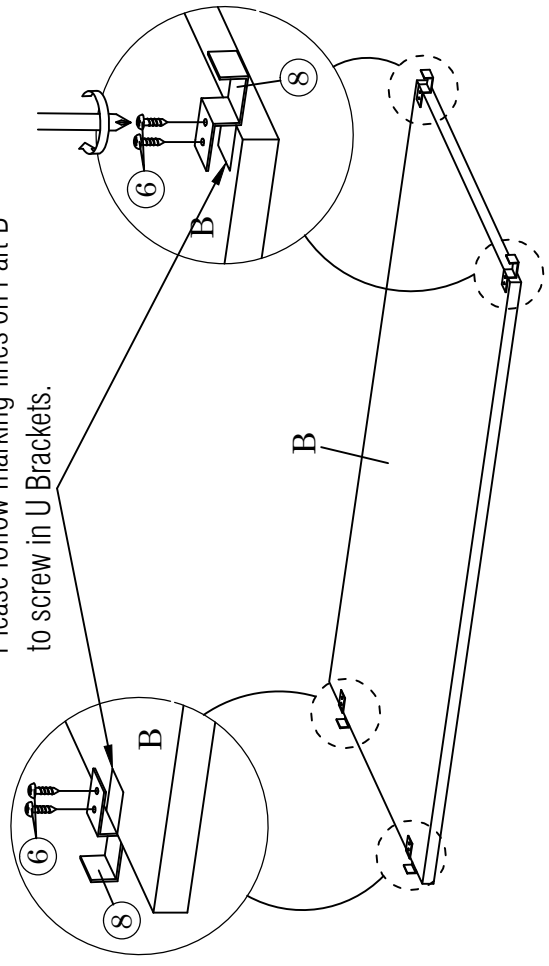



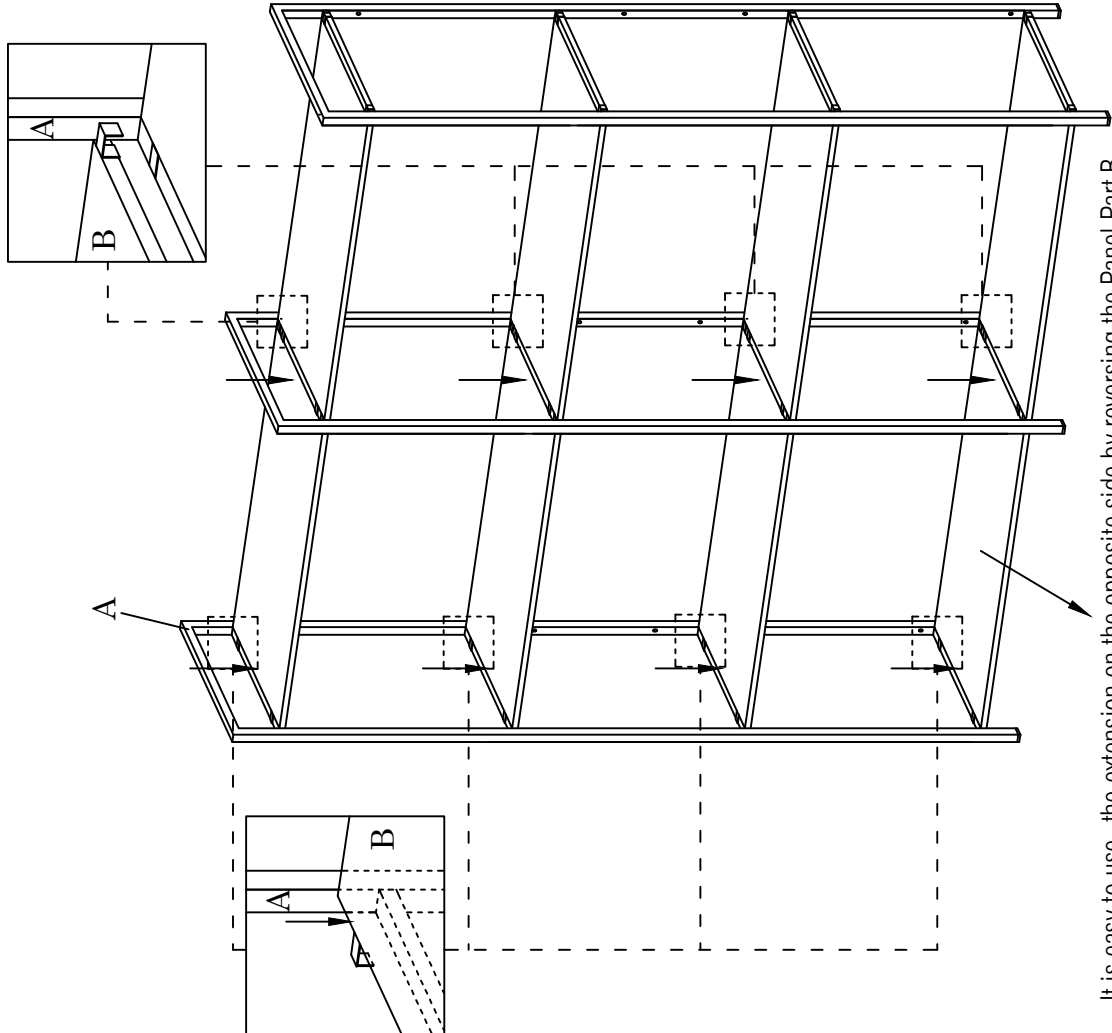

3

\*Please make sure the u bracket hang in the same position.





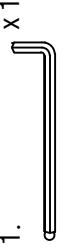

It is easy to use- the extension on the opposite side by reversing the Panel Part B

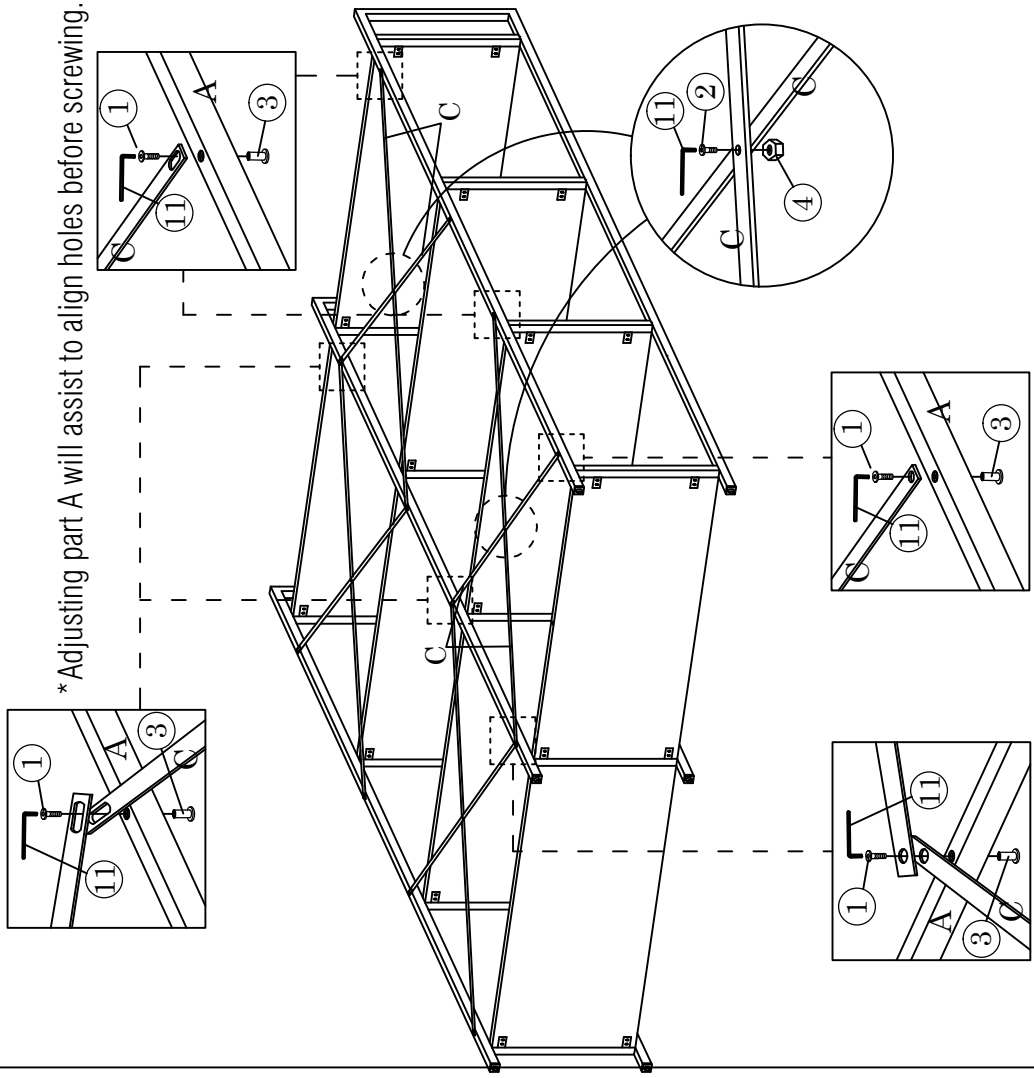
# AXEL-EXTENSION SHELVING UNIT - MEDIUM (1430 x 800mm)

4	1.  x 4	2.  x 2	3.  x 4
	JCBC M6 x 20mm	JCBC M6 x 16mm	JCN NUT M6 x 15mm
		4.  x 2	11.  x 1
		M6 HEX NUT	ALLEN KEY WITH BALL



5.  x 2	6.  x 2
PAN HEAD SCREW M4 x 30mm	PAN HEAD SCREW M3.5 x 16mm
9.  x 2	10.  x 2
5003 L BRACKET	PLUG

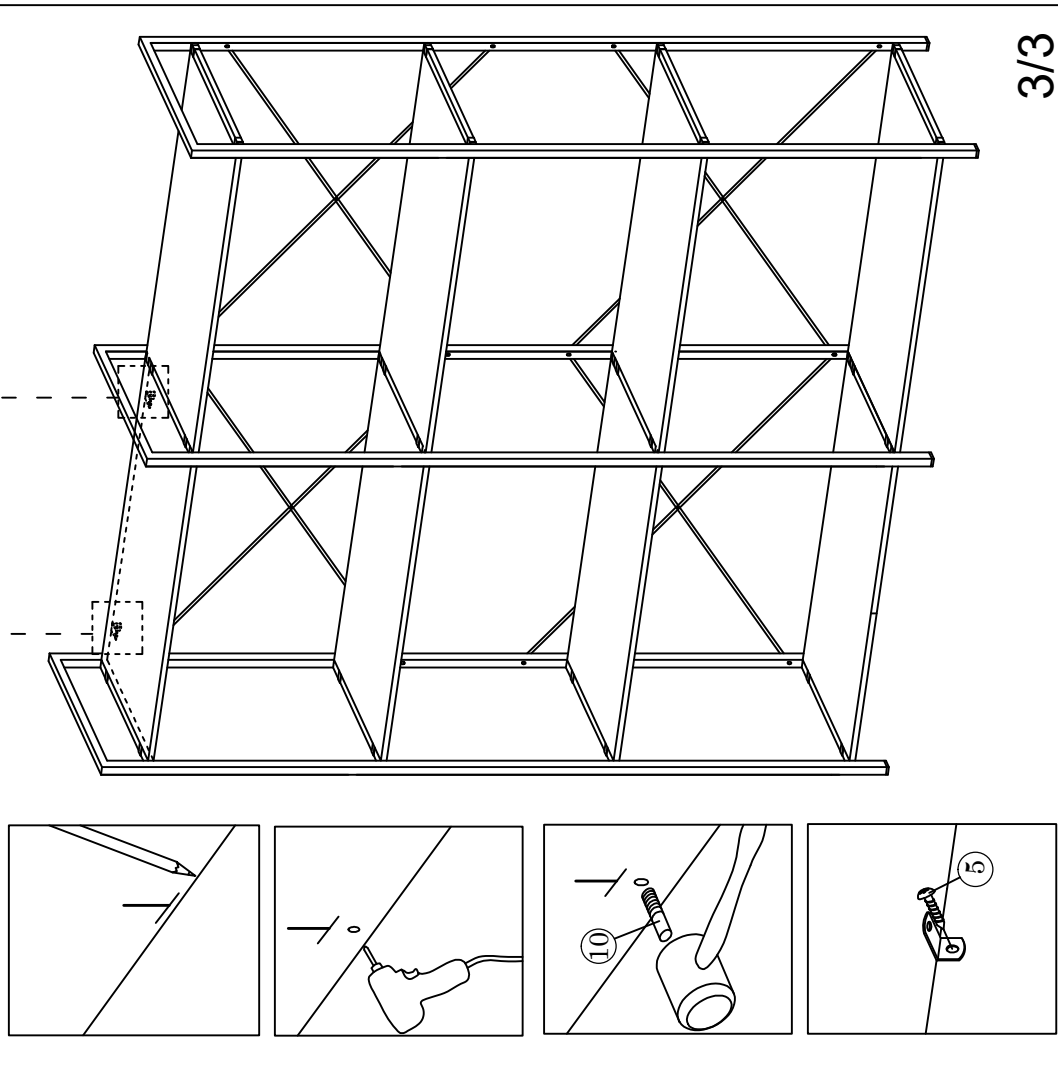

\* Adjusting part A will assist to align holes before screwing.