

milliard™

ROUND TABLE & 4 STOOLS

for kids!



PRODUCT MANUAL



Congratulations on the purchase of your new Milliard Round Table with Stools! Now your kids have their own furniture to work and play on, as well as spill, paint and, of course, eat. It's sized just for them, with lots of storage space to hold all their treasures where no grownups are allowed, and you can rest easy that your family's heirloom furniture in the rest of the house is safe. Win – win for everyone! Enjoy Milliard products and be sure to check out our other great items!

⚠️ WARNING: REVIEW ALL WARNINGS AND INSTRUCTIONS TO REDUCE THE RISK OF SERIOUS INJURY OR DEATH.

The table and chairs must be assembled by an adult.

Carefully inspect the table and chairs after assembly to ensure that they are stable and that there are no exposed screws or other sharp parts.

To avoid falls or strangulation, do not place the table near a window or a corded window treatment.

Do not allow children to climb on the table. The table may tip over or break, which could lead to serious injury or death.

To avoid choking hazards, do not allow children under the age of three to play with toys that contain small parts.

**Did your product arrive damaged or missing parts?
WE'RE HERE TO HELP.**

Our team of dedicated customer care professionals are ready to help you with any questions or concerns. For immediate attention, call us.

Or you can leave a voicemail or email and we guarantee you will hear back from us within one business day.

PHONE: 866-686-4891 **EMAIL:** info@milliardbrands.com

Milliard Enterprises LLC
1980 Swarthmore Ave
Lakewood, NJ 08701 USA
MADE IN CHINA

DISCLAIMER: Milliard™ assumes no liability or responsibility for accidents or injuries to persons or properties associated with the improper use of this product, nor does Milliard condone prohibited or unlawful uses. This product must be used as directed and all safety precautions must be followed at all times in accordance to federal and local laws or regulations. Buyer assumes all risks and liability from misuse of this product and Milliard shall not be held liable beyond the initial purchase cost of the product for any damages arising from its misuse.

PARTS

1

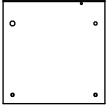

10" STOOL PANEL LEFT (X4)

2

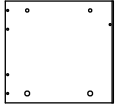

10" STOOL PANEL RIGHT (X4)

3

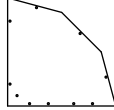

STOOL BOTTOM (X4)

4



5" STOOL PANEL CENTER (X4)

5



5" STOOL PANEL RIGHT (X4)

6



5" STOOL PANEL LEFT (X4)

7



STOOL TOP (X4)

8

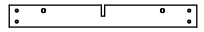

UPPER TABLE SUPPORT (X2)

9

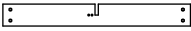

LOWER TABLE SUPPORT (X2)

10



TABLE LEGS (X4)

11

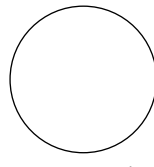

TABLETOP (X1)

A



BOLT (X36)

B



DOWEL NUT (X36)

C



WOOD DOWEL PEG (X32)

D

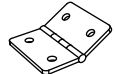

HINGE (X8)

E



SHORT SCREW (X32)

F



LONG SCREW (X20)

G



STOOL PAD (X16)

H

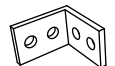

BRACKET (X2)

I



CAM LOCK (X24)

J

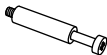

CAM NUT (X24)

K



MEDIUM SCREW (X20)

L



TOOL (X1)

ASSEMBLY

1

» Begin by assembling the stools.

Take one of each **10" stool panel (1)** and **(2)**. Into the **right stool panel (1)**, insert **dowel nuts (B)** into the holes on the wide sides and **wood dowel pegs (C)** into the inner holes on the narrow sides. Attach the left stool panel to the right stool panel by inserting bolts through the holes on the outside of the left stool panel.

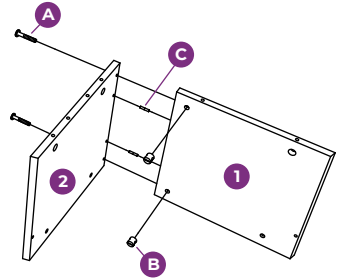

2

Now you will attach the **stool bottom (3)**.

Begin by inserting 3 **dowel nuts (B)** into both the right and left stool panels, as shown. Insert **wood dowel pegs (C)** into the holes in the stool bottom that do not go through and through.

Then turn the whole unit upside down and insert 3 **bolts (A)** into the holes in the stool bottom.

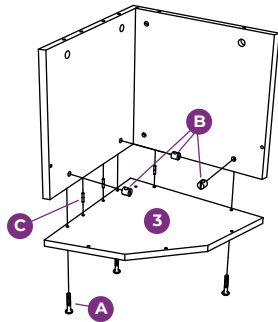

3

In this step you will assemble the stool front.

Line up one of each center, right and left 5" panels (**4, 5, and 6**) and attach them to each other using 2 **hinges (D)** and 8 **short screws (E)**.

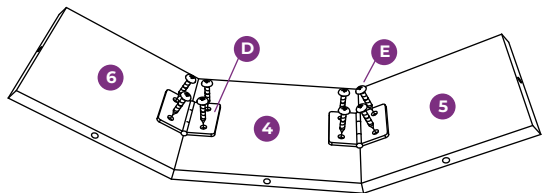

ASSEMBLY

4

Now you will attach the set of 5" panels to the stool bottom using 3 **long screws (F)**.

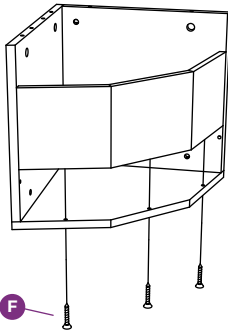

5

Secure the 5" stool panels to the 10" stool panels using another **long screw (F)** on each side.

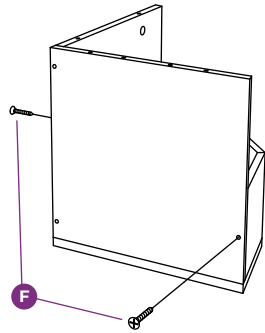

6

Attaching the **stool top (7)**.

Insert 3 **cam locks (I)** into the stool sides and 3 **cam nuts (J)** into the corresponding holes on the stool top. Insert **wood dowel pegs (C)** into the remaining 2 holes in the stool top.

Make sure that the arrows on the cam locks are facing downwards. To lock each cam lock, turn each one clockwise 90 degrees.

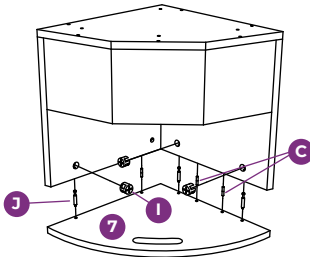

7

Attach 4 **stool pads (G)** using the **medium screws (K)**.

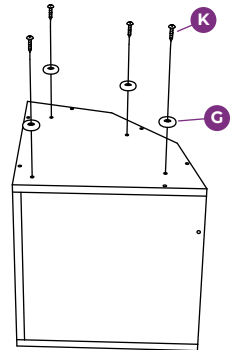

» Repeat steps 1-7 for the remaining 3 stools.

ASSEMBLY

8

» Now begin assembling the table.

Wedge the **upper table supports (8)** into each other and the **lower table supports (9)** into each other.

Note: the upper table supports have holes along the long edge for connecting to the tabletop; the lower table supports have holes in the center for attaching brackets.

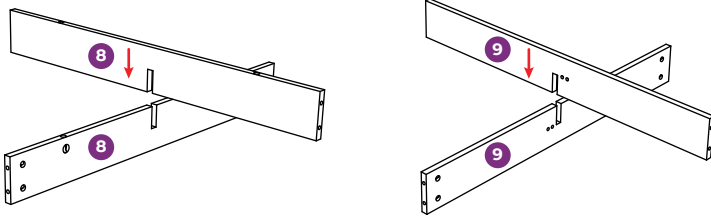

9

Attaching the **table legs (10)** to the table supports.

Note that the holes on the table legs are closer to the edge on one end. This is the end that should connect to the upper table supports. Insert **dowel nuts (B)** into all the holes on the wide side of the table supports. Insert **bolts (A)** into all the holes on the wide sides of the table legs and screw them in.

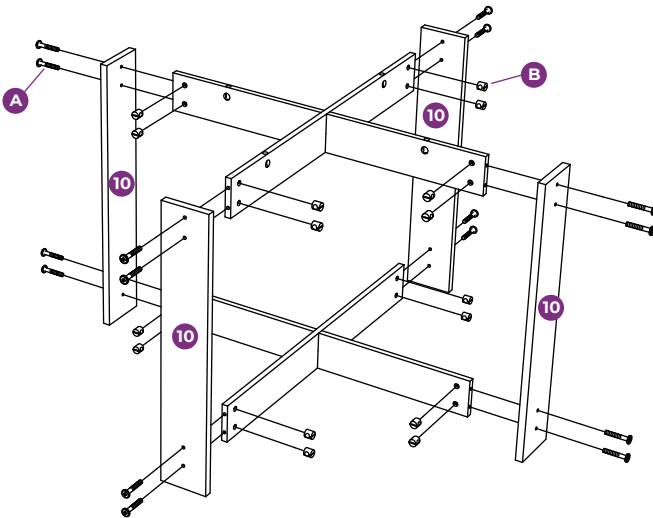

ASSEMBLY

10

Attach the **brackets (H)** on opposite sides of the lower table supports using **short screws (K)**. As mentioned in step 8, the lower table supports have bracket holes in the center.

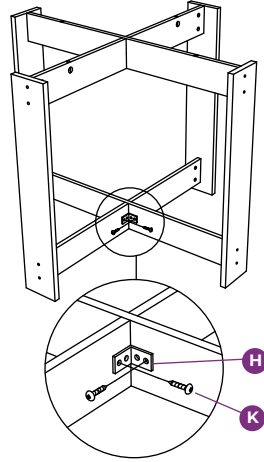

11

Now it is time to attach the **tabletop (11)**. Insert **cam locks (I)** into the holes in both the upper table supports and the tops of the table legs. Make sure that the arrows on the cam locks are facing downwards. Insert **cam nuts (J)** into the corresponding holes on the tabletop. Attach the tabletop to the table support and turn each cam lock clockwise 90 degrees.

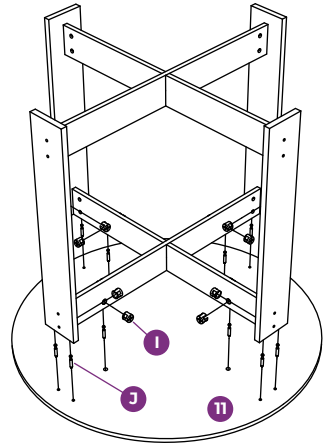

You are done! Great job!

milliard[™]

PHONE: 866-686-4891

EMAIL: info@milliardbrands.com