

HOW TO PUT THIS SH*T TOGETHER

TUSHY Oasis
Non-Electric Bidet Seat



TUSHY

hellotushy.com

Congratulations!

You're minutes away from ultimate booty bliss.
This manual will guide you step by step through your
TUSHY Oasis installation, turning your toilet into total self-care.

Online video resources:
(for our visual learners)

<http://hellotushy.com/oasis>



Table of Contents

4 **Meet This Manual**

5 **Meet Your TUSHY Oasis**

8 **Before You Start**

17 **Prepare Your Toilet**

20 **Connecting Your TUSHY Oasis**

34 **Know Before You Go**

36 **How to Use Your TUSHY Oasis**

40 **Frequently Asked Questions**

42 **Warnings & Safety**

44 **Troubleshooting**

46 **Warranty**

48 **Contact Information**

1 Meet This Manual

Get into the groove

Let's get this POTTY STARTED! Turn on some rump-shakin' TUSHY Tunes. We've assembled the perfect tracks to get you in the mood to upgrade your toilet, your booty, and your life. hellotushy.com/tunes



Get comfy

Lay down a towel or the TUSHY box for some extra padding for your knees.



Have a question?

Our Customer Experience Poo-Rus are ready to help. Email install@hellotushy.com, chat with us on hellotushy.com, or text MYTUSHY to 794-54 (US only) or 1 (888) 599-8926 (Canada only).

*By signing up via text, you agree to receive recurring automated promotional, personalized marketing text messages (e.g. cart reminders), and bumperful puns from TUSHY at the cell number used when signing up. Consent is not a condition of any purchase. Reply HELP for help and STOP to cancel. Msg frequency varies. Msg & data rates may apply. View Terms (<https://hellotushy.com/pages/terms-of-use>) & Privacy (<https://hellotushy.com/pages/privacy-policy>)

2 Meet Your TUSHY Oasis

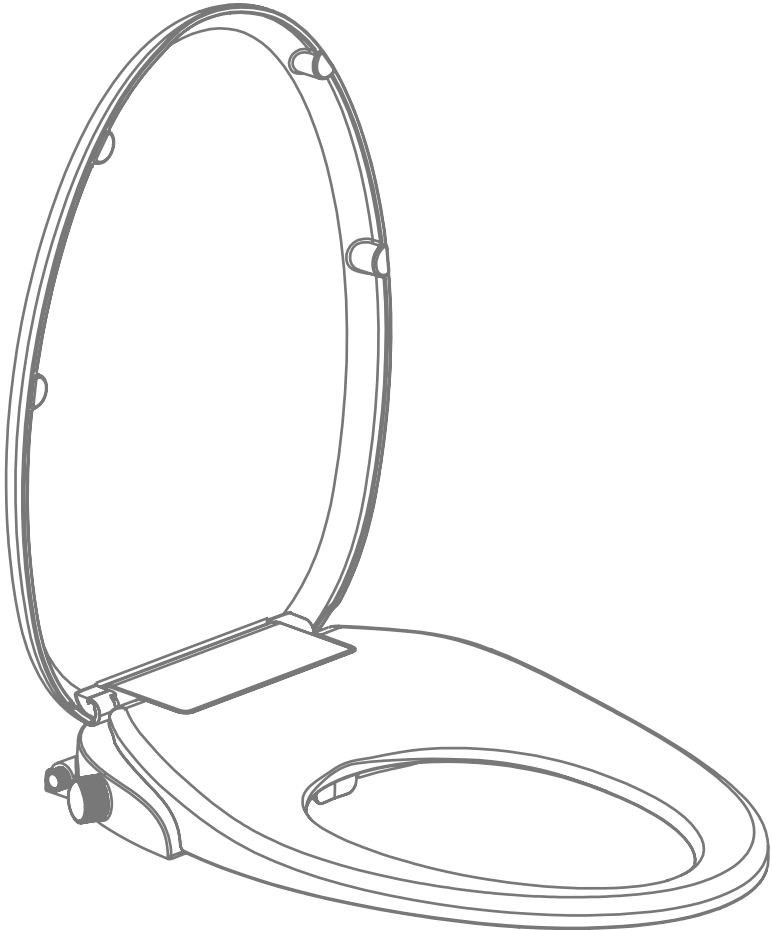

Included parts

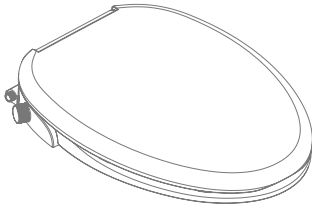

TUSHY Oasis

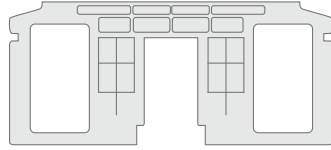

Base Plate
(Attached to the bottom of the TUSHY)



Tank Adapter
($\frac{1}{8}$ " x $\frac{7}{8}$ " x $\frac{3}{8}$ " Compression)



Hot Water Supply Cap

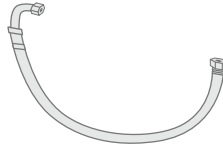

Flexible TUSHY Hose
($\frac{3}{8}$ " x $\frac{3}{8}$ " Compression)

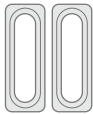

2x Mounting Brackets

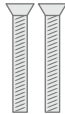

2x Mounting Bolts



2x Top-Mounting Rubber Inserts



2x Bolt Washers

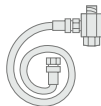

Brass Mini Adapter
($\frac{3}{8}$ " x $\frac{3}{8}$ " x $\frac{3}{8}$ " Compression)
& **Polyurethane Tube**
(6 Feet, $\frac{3}{8}$ " x $\frac{3}{8}$ " Compression)

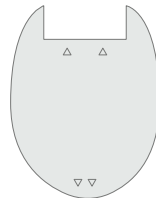

Mounting Template

You'll Also Need:

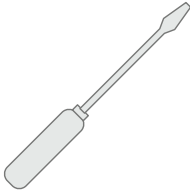

**Flathead
Screwdriver**

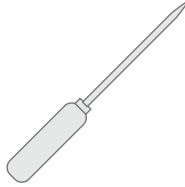

**Phillips Head
Screwdriver**

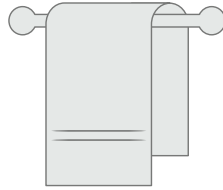

Towels
(for any spills)

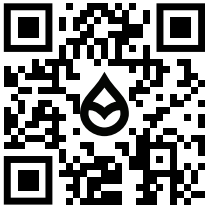

Scan this code to watch
our TUSHY Oasis install video
or go to hellotushy.com/oasis

TUSHY TIP

Keep all of these parts (and this manual) just in case you need them in the future!

3 Before You Start

Warnings and safety

Read all instructions before installing or using your TUSHY Oasis. Failure to do so could result in property damage. Always turn off the water supply valves before installing or performing maintenance on your TUSHY Oasis.

When tightening connections, make sure they are finger tight, but be careful not to overtighten as this could result in leaks or property damage. Make sure you check for leaks after installing your TUSHY Oasis and periodically thereafter.

If you're not sure about something, please consult a plumber or send us an email at install@hellotushy.com.

When using your TUSHY, turn the pressure knob slowly. Increasing the pressure too fast may lead to discomfort or injury.

Check Your Toilet

(There are different kinds of toilets? Who knew?)

1. Which bowl shape do you have?

ROUND

A round bowl is typically shorter and rounder. It is commonly found on older toilets.

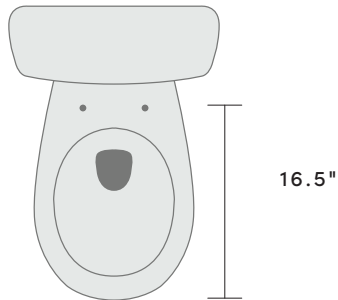

ELONGATED

An elongated bowl is typically longer and more egg-shaped. It is commonly found on newer toilets.

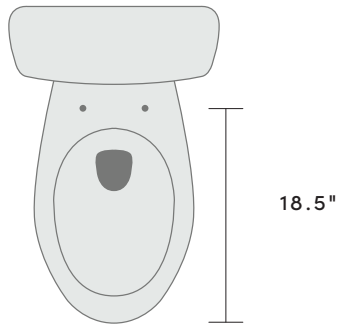

Make sure your TUSHY Oasis matches your toilet's bowl shape. If they don't match or if you are unsure, reach out to install@hellotushy.com and we'll help you out.

2. Which type of toilet do you have?

The Standard

MOST
COMMON



The Standard Toilet is the most common toilet you'll find in the majority of residential homes. It typically has two pieces, consisting of the bowl and the tank, and has a flexible steel hose connection between the water supply and tank. Most importantly, all of the water supply connections are visible. If you've got the Standard, you'll be good to go in no time!

If you have any questions at all,
email install@hellotushy.com
and we will be able to assist you.

The Skirted



Skirted Toilets are a more modern, clean design that may hide the external tank connection. If you are able to access the tank connection, awesome! You shouldn't have too much trouble.

If you aren't able to access the tank connection, check out hellotushy.com/oasisskirted for tips on how to connect these toilets with the valve adapter. We'll get you set up in no time.

If you have any questions at all,
email install@hellotushy.com
and we will be able to assist you.

The Flushometer



The Flushometer Toilet is normally found in commercial buildings, but some residential apartment buildings have these toilets too (looking at you, NYC friends). They have a lever with a powerful flush and no easy access to a water supply connection. At first glance, these toilets don't look TUSHY compatible, BUTT... we have a hack for that. ;)

If you have a flushometer toilet, check out hellotushy.com/flushometer for guidance on how to connect these toilets relying on your sink with a valve adapter and longer hose.

If you have any questions at all,
email install@hellotushy.com
and we will be able to assist you.

The French Curve

MAYBE



Do you oui oui in this type of potty? **French Curve Toilets** are one-piece toilets that are curved in the back. Though they are very high-end, they also tend to be hard to fit when it comes to any bidet seats or attachments.

To see if your toilet is compatible,
check out hellotushy.com/compatibility

If you have any questions at all,
email install@hellotushy.com
and we will be able to assist you.

3. Check your water connection

Before you connect:

Check your toilet's water connections and ensure you have good sink access! It takes 10 seconds.

Cool water connection

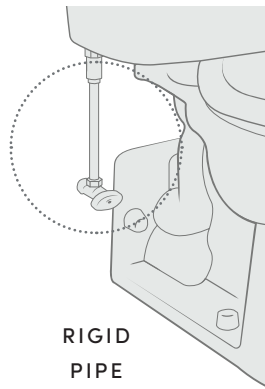
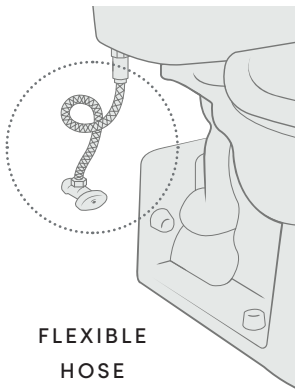

Cool water check:

If you have a flexible hose (left) you're good to go. If you have a rigid pipe, contact our Poo-Rus and we will send you a flexible pipe to replace it. For an installation video on how to replace your rigid pipe, go to hellotushy.com/flexhose.

If you have any questions at all,
email install@hellotushy.com
and we will be able to assist you.

Warm water connection

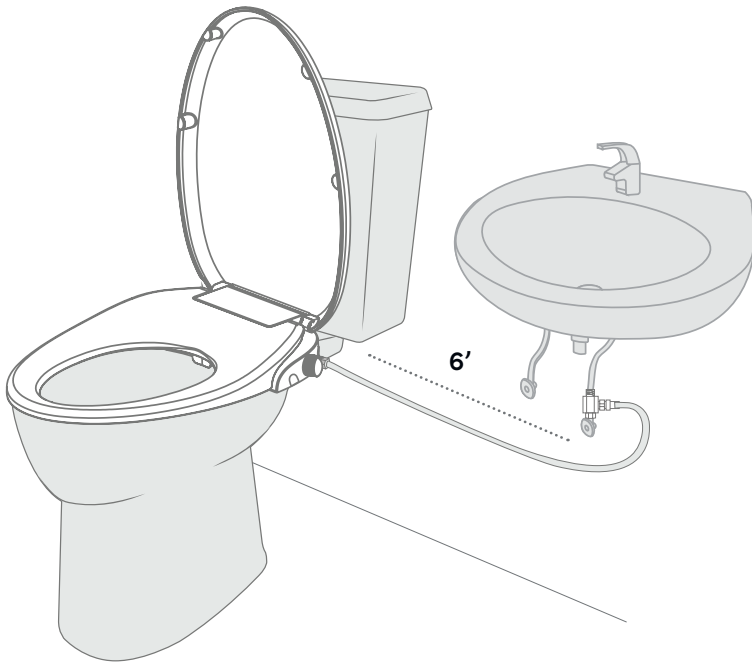

Warm water check:

Make sure you can access the warm water supply under your sink and that the toilet is within 6 feet. Sink too far away? No sweat, grab a longer hose at hellotushy.com/parts.

If you have any questions at all,
email install@hellotushy.com
and we will be able to assist you.

Your TUSHY Oasis

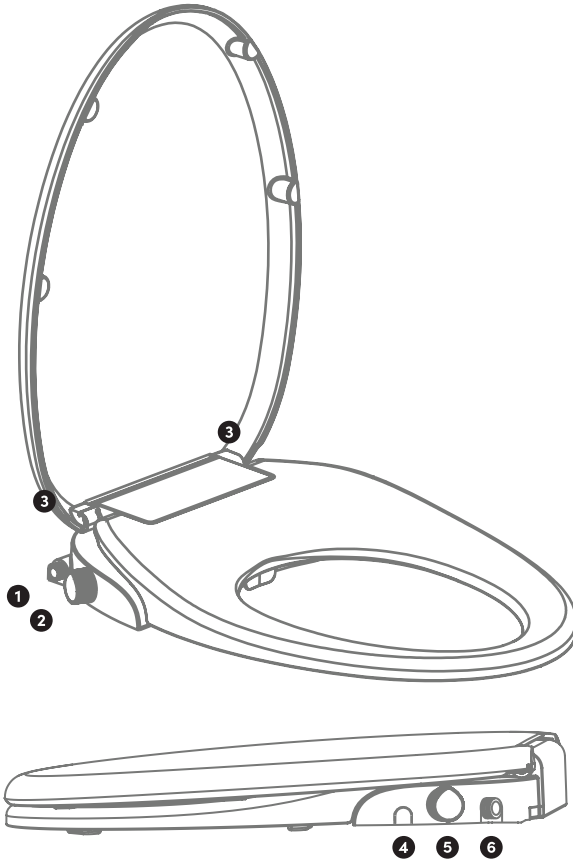

- ❶ Cold water inlet port
- ❷ Pressure knob
- ❸ Lid and seat sliding lock

- ❹ Quick release button
- ❺ Temperature knob
- ❻ Warm water inlet port

4 Prepare Your Toilet

STEP 1 Turn off your water supply valves



A Turn off the warm water valve beneath the sink by turning it clockwise.

⚠ CAREFUL! It might be hot.



B Then, turn off the water valve beside the toilet by turning it clockwise.

TUSHY TIP

If the valve is tight, there may be some mineral buildup. In that case, try twisting in one direction and then the other, each time rotating a little further until it's free to turn all the way around. Slow and steady wins the race!

If you don't have access to the water supply connection beside the toilet, you can use your sink's water supply instead. For an installation video, go to hellotushy.com/sinkconnect.

STEP 2 Empty the toilet tank

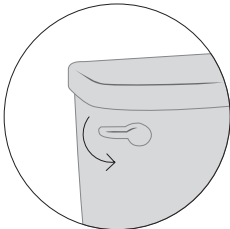

Flush your toilet to drain the tank. Hold down that flusher until the tank empties nearly completely! An inch of water at the bottom is okay, though.

STEP 3 Remove the toilet seat

For most toilet seats, flip up the bolt caps behind the seat with a flathead screwdriver to access the bolts. Turn counterclockwise to loosen the bolts. Remove the seat and either store it (in case you ever need it) or bury it (in case you want to give your old seat a proper goodbye). Just kidding, recycle it!

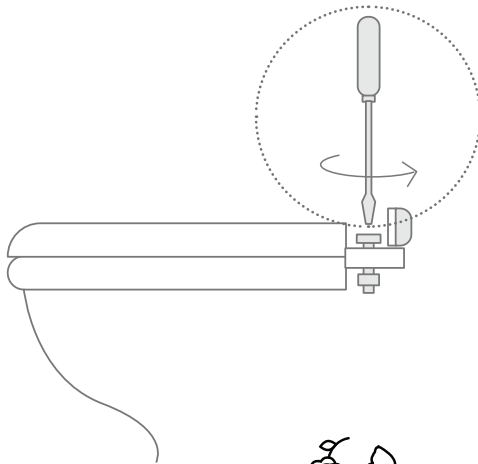
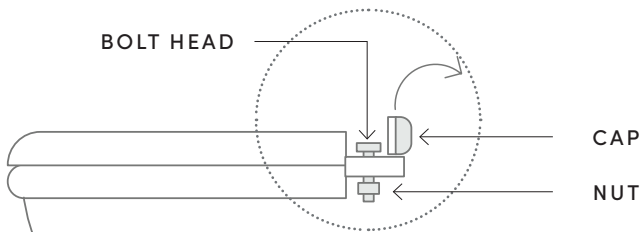

MIGHT WE ADD: YOUR
SH*T SMELLS OF ROSES

TUSHY TIP

You may need to hold the nut on the underside of the bolt with your other hand (using pliers or a towel if necessary) while unscrewing. If your toilet is dirty—hey, it happens!—it's the perfect time to clean it!

Got a unique quick-release or mounted toilet seat?



Simply unscrew the bolts fastening the quick-release mounts to the toilet. You can remove them and store them with your seat if you ever need to reinstall it. The bolts may be under a plastic or metallic cover.



Stuck like
a dingleberry?
Watch a tutorial.

Once you've got the seat off, set it aside and you're done!

5 Connecting Your TUSHY Oasis

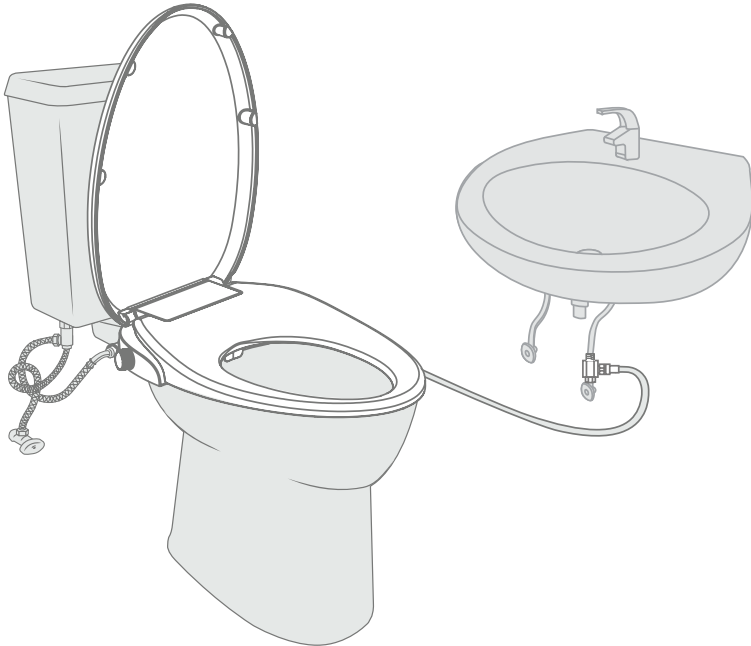

STEP 4 Connect to the cool water

A **Disconnect** the existing flexible hose from your toilet tank by turning it clockwise if you're looking at the connection from above. Be prepared to catch or wipe up some residual water that might spill onto the floor.

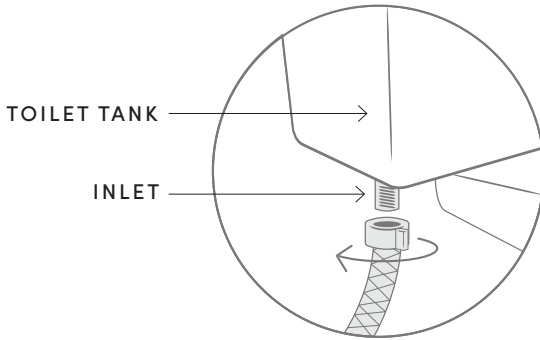

B **Screw** the existing flexible hose to the bottom of the Tank Adapter and then screw the top of the Tank Adapter counterclockwise onto the tank if you're looking from above. Make sure the black rubber gasket is inside the top of the adapter before screwing. Be careful not to overtighten!

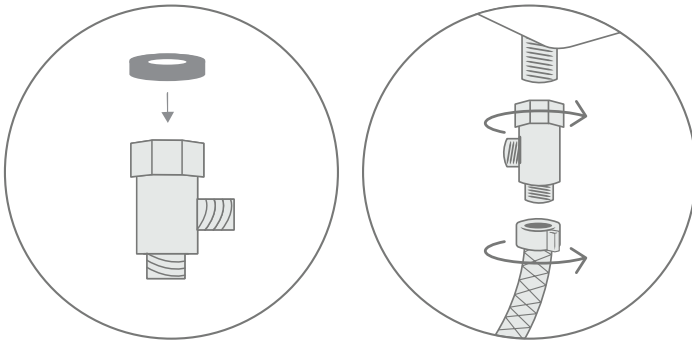

c **Screw** the provided Flexible TUSHY Oasis Hose onto the Tank Adapter's side connection. Be careful not to overtighten!

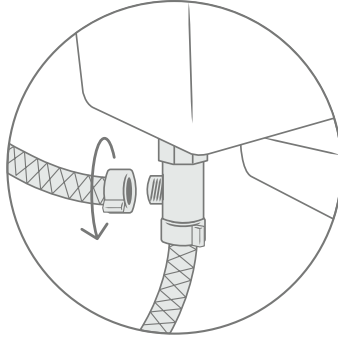

G'DAY TO YOUR
REAR ADMIRAL

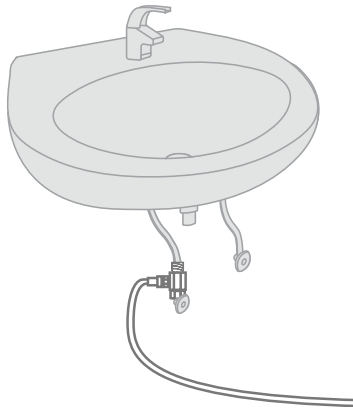

STEP 5 Connect to the warm water

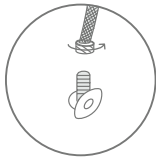

A Disconnect the existing flexible steel hose from the warm water supply valve on your sink by turning it counter-clockwise.

⚠ CAREFUL! It might be hot.

Do you have a rigid metal or plastic pipe? No problem. Visit hellotushy.com/sinkflexhose or your local hardware store to get a flexible hose. (You'll want a flexible steel hose that's $\frac{3}{8}$ " x $\frac{1}{2}$ " compression.)

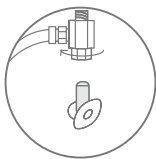

B Fasten the mini adapter to the warm water supply valve by turning its hex nut on the mini adapter clockwise. Make sure to not over-tighten! The adapter doesn't need a lot of force to seal.

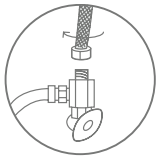

C Reconnect the existing flexible steel hose to the top of the mini adapter by turning it clockwise. Again, make sure to not over-tighten!

Warm water connection didn't work out?

We'll convert your TUSHY Oasis to a TUSHY Wave. Screw the inlet cap provided in the box onto the hot water inlet port. Voila! You can save the warm water part of the installation for another toilet, another day and still use TUSHY. Visit hellotushy.com/inletcap for a how-to video.



STEP 5 Attach your TUSHY Oasis Base Plate to the bowl

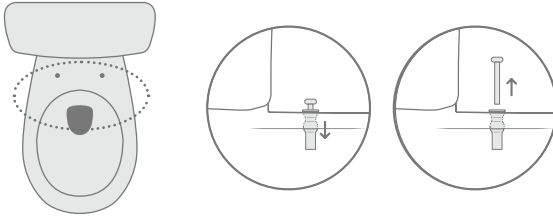

- A** Insert the included Top-Mounting Rubber Inserts and Mounting Bolts into the toilet bolt holes until they are nearly flush with the surface. Keeping the Mounting Bolts inside the Rubber Inserts will provide a firm guide to push the rubber down into the holes. Once the Rubber Inserts are in place, unscrew the Mounting Bolts and set them aside until the end of Step 5.

TUSHY TIP

If you're having trouble getting the Rubber Inserts into the toilet bolt holes, use some soapy water to help them slide in easier!

- B** Place the included Mounting Template on the toilet, aligning its front edge with the front edge of the toilet rim. Remove the Base Plate from the bottom of the TUSHY by pressing the quick release button and sliding it out. Align the Base Plate in the Mounting Template over the toilet bolt holes, ensuring it is centered and straight, with the rubber non-slip pads facing down. Tape the Mounting Template in place for ease throughout this process.

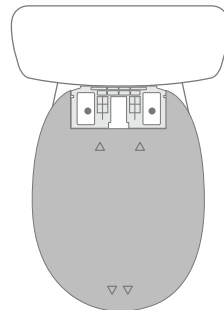

- C** Line up the included Mounting Brackets with the rough edges facing down on the Base Plate directly over the toilet bolt holes. The Mounting Brackets should click into the grooves in the Base Plate to stay in place.

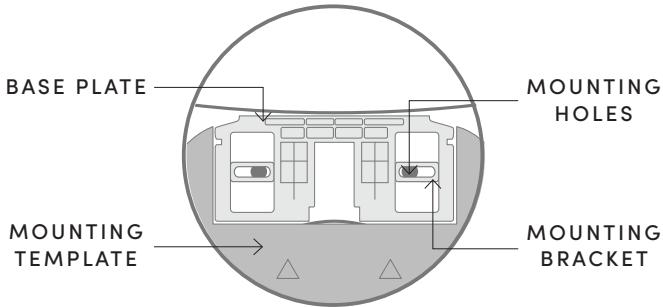

- D** Slide the Bolt Washers onto the Mounting Bolts. Insert the Mounting Bolts through the top of the Mounting Brackets. Tighten them using a Phillips head screwdriver by turning clockwise until the Base Plate is tight enough to stay in place. This could take a little while— just keep screwing. Be careful not to overtighten. Remove the Mounting Template once the bolts are screwed down and the Base Plate is secure.

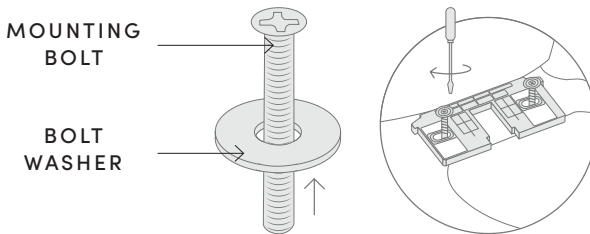

TUSHY TIP

While you're tightening the screws, check intermittently to see if the Mounting Bracket feels snug. If it still wiggles, keep tightening. If it feels snug, you're all set!

STEP 7 Slide your TUSHY Oasis onto the Base Plate

Next, place your TUSHY onto your bowl in front of the Base Plate. You will notice that on the bottom of the main body there are two slots that will slide onto the Base Plate. Line those up with the Base Plate and slide towards the back of your toilet until it clicks into place and securely locks.

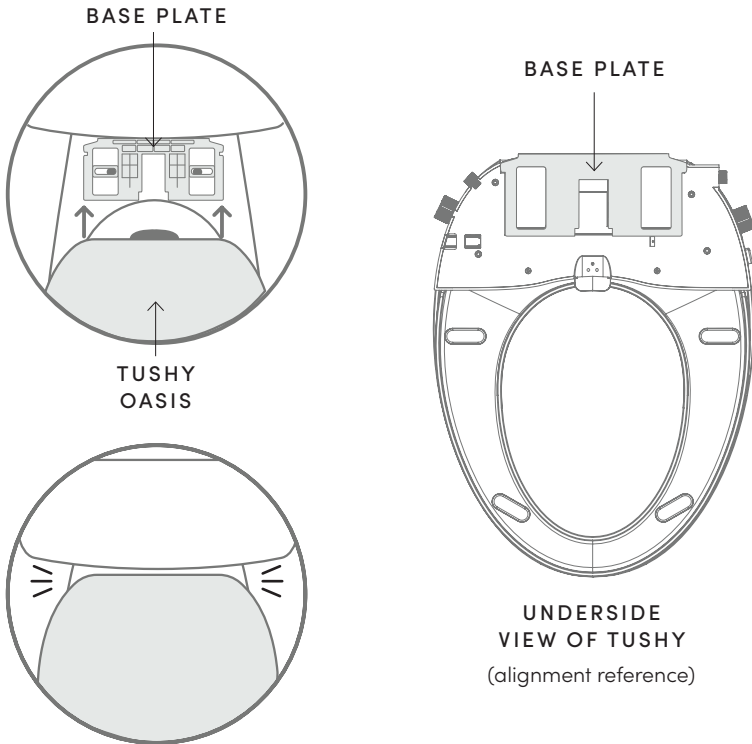

PREPARE TO POOP
WITH EXCELLENCE

Check your TUSHY alignment

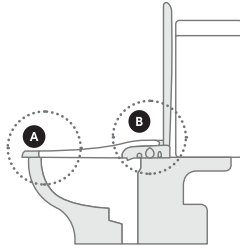

A No lip overhang or underhang

If you need to adjust the position of your TUSHY, measure the amount of overlap at the front of your bowl so you can adjust the Base Plate accordingly.

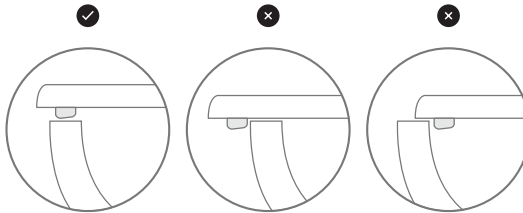

B Sits flat on toilet bowl

Make sure your TUSHY lies flat on your toilet bowl so the nozzle can function properly. Move it forward if the nozzle is resting on the edge of the bowl.

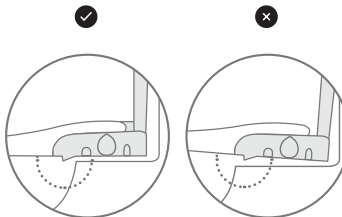

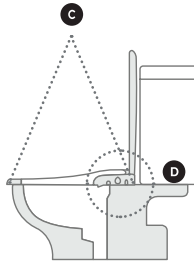

C Centered on bowl

Make sure your TUSHY is straight on the toilet bowl.

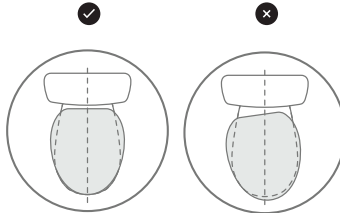

D Enough space for lid

Make sure there is enough space between the TUSHY and your tank so the lid can open properly. If the lid or seat do not stay open because they are hitting the tank, shift the mounting plate forward to give more clearance. See the following TUSHY Tip.

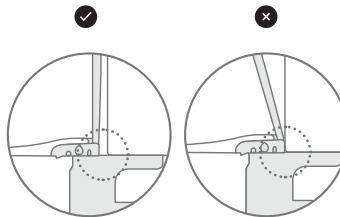

TUSHY TIP

To adjust the TUSHY position, remove the TUSHY from the mounting plate by pressing the Quick Release button on the right hand side and pull the TUSHY away from the tank. Then, loosen the Mounting Bolts and adjust the Base Plate until it is in the desired location before reattaching your TUSHY.

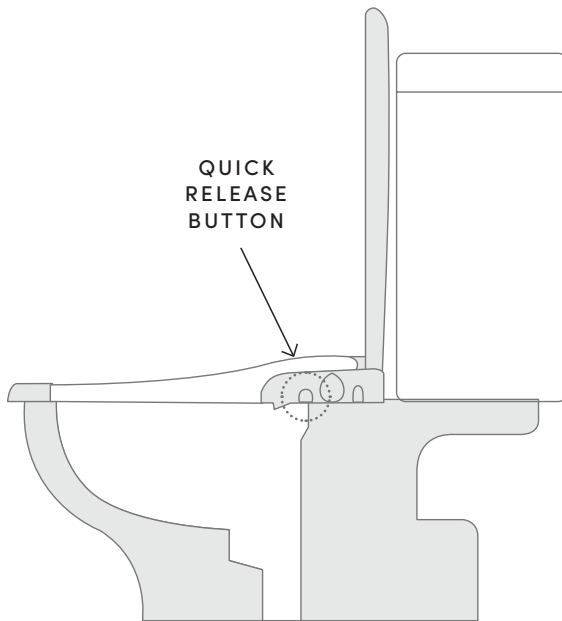

WE DON'T MEAN TO BE
ARISTOCRASS, BUT YOU'RE
THE CREAM OF THE PLOP

STEP 8 Finish the water connection

A Cool Water Connection

Take the elbow end of the Flexible TUSHY Hose attached to the Tank Adapter and screw it onto the cold water inlet port of the TUSHY in a clockwise direction if you are facing the cold water inlet port side of the TUSHY. Do not overtighten—finger tight is just right. If you cannot connect the elbow end of the hose to the inlet port due to space constraints, flip the hose and attach the elbow connector to the tank adapter and the straight hose end to the inlet port of the bidet.

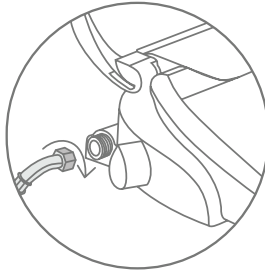

B Warm Water Connection

Take the unattached end of the white Polyurethane Tube that is connected to the warm water valve and screw it onto the warm water inlet port of the TUSHY in a clockwise direction if you are facing the warm water inlet port side of the TUSHY. Do not overtighten—finger tight is just right.

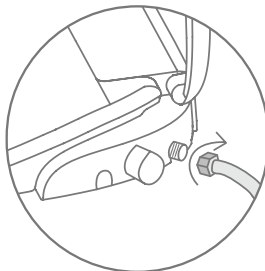

STEP 9 Check for leaks

This is a super important step so that we can avoid any leaks. Nobody wants that.

Turn each valve on and off slowly one time to check the water connections for any leaks. Be sure to touch each hose to ensure water isn't running down them. Once there are no leaks, make sure your water valve is open, leave a towel or a bowl below the connections, and check back in an hour to ensure there are no slow leaks that may not be instantly visible. If you are experiencing leaks, first make sure the black rubber gasket is placed correctly inside of the Tank Adapter. Second, ensure the threads are aligned properly. Third, make sure the hoses and adapters are tightened completely, but remember not to overtighten! If there is any water present after an hour, repeat the steps above. If not, you are good to go!

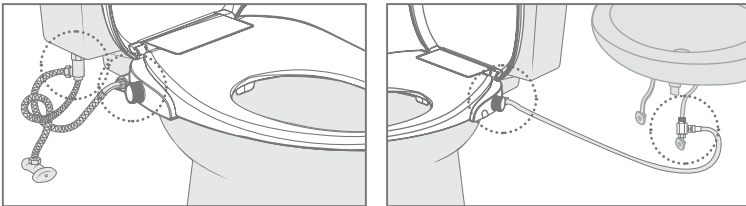

WARNING

If you are still having leaks, flip to our Troubleshooting section before continuing. Slow drips can cause a big headache.

**Your booty is now
ready for the clean
of a lifetime!**

If you have any questions or concerns at all, consult a plumber, email **install@hellotushy.com**, or text us at MYTUSHY to 794-54 (US only) or 1 (888) 599-8926 (Canada only), and we will be able to ASSist you.

6 Know Before You Go

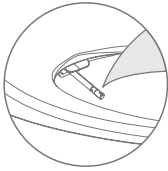

Don't spray until you sit down.

We know you'll be tempted, but unless you want a spray to the face or a soaked bathroom, don't spray until your butt is on that seat.

Turn the pressure knob very slowly.

Adjust the water pressure slowly, starting on the weakest setting and easing into the spray intensity you desire. Be cautious as you turn the pressure knob to avoid discomfort or injury, and find your ideal comfort level.

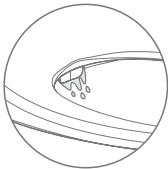

Let the nozzle do its thing.

If you get a little schmutz on the nozzle, don't freak! The self-cleaning nozzle rinses itself off every time you use your TUSHY.

Spray responsibly.

TUSHY's knob increases from a gentle spritz to a powerful wash to accommodate varying home water pressures. If your water pressure is exceptional, using TUSHY at its top setting (especially for a long time) could cause irritation or other issues. TUSHY is meant to wash away the bad bacteria, not power wash the good bacteria. For best butt health practices, talk to your doctor.

External use only.

TUSHY is designed to wash the body parts you can see. As the water comes from your tap, it is not safe nor recommended to use as a douche or enema—doing so is dangerous and will likely cause bodily harm. For best butt health practices, talk to your doctor.

7 How to Use Your TUSHY Oasis

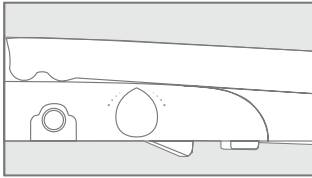

RIGHT SIDE VIEW:
PRESSURE KNOB

Pressure Control Knob

The Pressure Control Knob is located on the right side of the bidet (during use), next to the cold water inlet port.

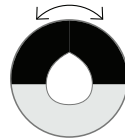

Rear Spray

To wash your booty after pooping, turn the knob counterclockwise while seated (toward the toilet tank). The water pressure increases the more you turn the knob, and every house has different pressure. So go slow to start!

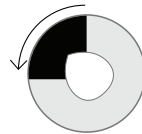

Front Spray

Now do the opposite to clean your front. Bidets are great at cleaning vulvas, too! Slowly turn the knob clockwise while seated (away from the toilet tank) to gradually increase the water pressure.

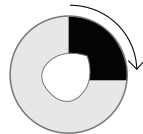

Nozzle Wash

TUSHY Oasis nozzles automatically self-clean when you turn on Rear or Front cleansing mode. This ensures every spray is pristine when it hits your bottom! The nozzles will continue to self-clean everytime you use the TUSHY.

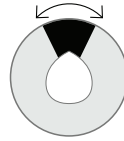

Off

To stop the water flow, turn the knob to its original position between the Rear and Front cleansing modes. You should feel a click when it's turned off.

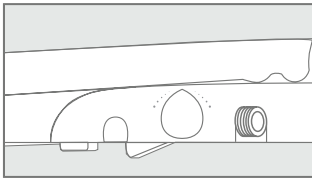
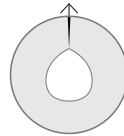

LEFT SIDE VIEW:
TEMPERATURE KNOB

Temperature Control Knob

The Temperature Control Knob is located on the left side of the bidet (during use), next to the warm water inlet port. To adjust the water temperature:

Turn the knob clockwise (away from the toilet tank) to increase the temperature for warmer water.

Turn the knob counterclockwise (toward the toilet tank) to decrease the temperature for cooler water.

WARM COOL

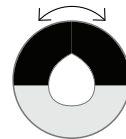

Special functions / features

Removable lid/seat

The TUSHY Oasis has a simple slide-on/off lid and seat for easy removal and cleaning.

To remove the lid: Unlock the lid by lifting it upward and sliding the lock on the left hinge to the LEFT. Shift the left side of the lid back. Then slide the lid to the right to detach from the base.

To replace the lid: With the lid in the open position, slide the lid hinge pin into the hole on the base. Place the lid sliding lock (in the open position) behind the left hinge pin on the base. Slide the lid forward. The base pin will be inside the sliding lock. Then slide the lock to the right to reattach.

To remove the seat: Unlock the seat by lifting it upward and sliding the lock on the right hinge to the RIGHT. Shift the right side of the seat back then close the seat. Slide the seat to the left while gently raising its right side to detach from the base.

To replace the seat: With the seat in the closed position, slide the lid hinge pin into the base. Place the seat sliding lock (in the open position) behind the right hinge pin on the base. Slide the seat forward. The base pin will be inside the sliding lock. Lift the seat up then slide the lock to the left to refasten.

- ① Lid sliding lock
- ② Seat sliding lock

Removable lid/seat

LID REMOVAL

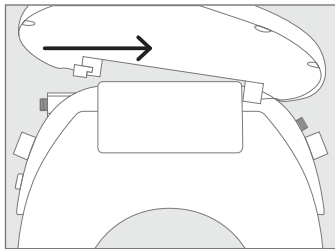
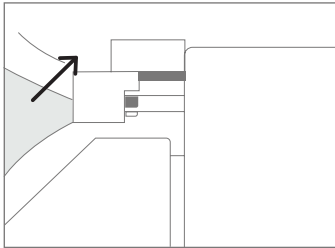
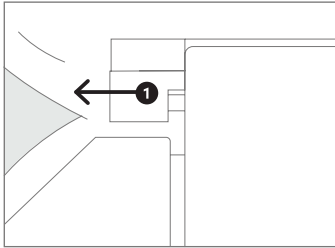
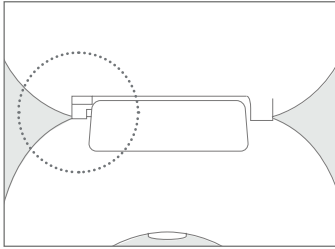

SEAT REMOVAL

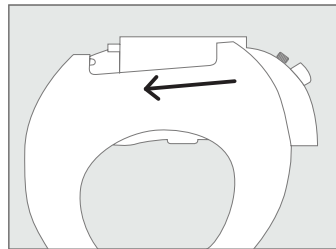
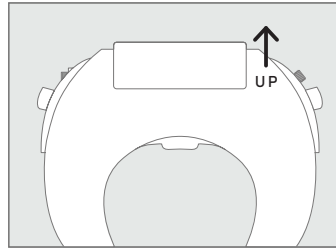
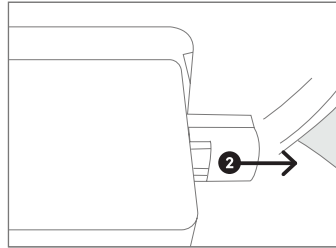
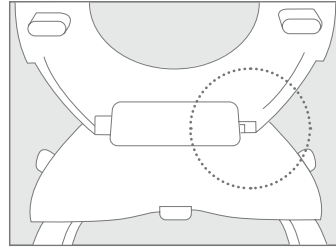

8 Frequently asked questions

Ok, but(t) how do I dry off?

If your booty is too busy to air dry, you can pat dry with our reusable, ultra-comfy TUSHY Bum Towels or our super sustainable, 3-ply Bamboo Toilet Paper designed to be extra absorbent. Using TUSHY dramatically reduces the amount of TP needed by 80%. Endless, irritating wiping turns into just a few nice pats when you're using TUSHY!

What will my friends think when they see my bum towel in the bathroom?

That you're a freakin' genius who not only cares for the planet, but also knows how to save money! If you lived in Europe, you'd have monogrammed bum towels for the whole family, so school your house guests about the ills of TP and show them the bidet side of life.

I need an extra doodad to install my TUSHY. What do I doo?

Just like butts, there is a wide variety of toilets. In an effort to support our sustainability goals, we send you the standard parts in your TUSHY install kit that we anticipate you'll need. However, if you have any installation trouble, please reach out to us directly as we have free and easy solutions for almost any issue you come across. Please contact us at install@hellotushy.com and we'll take care of you!

How do I clean my TUSHY bidet?

You should clean TUSHY as frequently as you do your toilet. The TUSHY Oasis has an easily removable lid/seat for fast cleaning around the hinges. Use a neutral PH mild cleaner to wipe down surfaces (avoid spraying directly onto your TUSHY) and manually pull down the nozzles. The nozzles are retractable and only come out of their poo-free cocoons when in use. You can also use the hands-free nozzle wash feature, which cleans by running water over the outside of the nozzles. And if you're looking for a new toilet brush, check out the sleek, eco-friendly TUSHY Brush!

⚠ CAUTION: Avoid using harsh chemicals such as bleach or bleach-based products on your TUSHY's water hoses. These can cause the hose to crack and lead to leaks and water damage.

9 Warnings & Safety

Read all instructions before installing or using your TUSHY.

Failure to do so could result in property damage, injury or death. Always turn off the water supply before installing or performing maintenance on your TUSHY.

When tightening connections, make sure they are tight, but be careful not to overtighten as this could result in leaks or property damage. Make sure you check for leaks after installing your TUSHY and periodically thereafter.

When using your TUSHY, turn the pressure knob slowly. Increasing the pressure too fast may lead to discomfort or injury.

Important Safeguards

Keep children away during the installation process and exercise caution when using the device around children. To avoid the danger of suffocation, keep the plastic bags away from babies and children. Do not use this bag in cribs, beds, carriages, or playpens. This bag is not a toy.

Do not attempt to open or perform internal maintenance on the TUSHY Oasis as this could result in injury, and will impact the performance of the bidet as well as void the limited warranty.

Read all instructions before using.

WARNING: Do not stand on the TUSHY. Doing so could result in property damages, injury or death.

WATER HAMMER WARNING: In the event that a loud banging noise occurs in the existing plumbing during installation, please cease using the device and consult a plumbing professional in order to prevent voiding your warranty and/or damaging your TUSHY.

⚠ CAUTION: Avoid using harsh chemicals such as bleach or bleach-based products on your TUSHY's water hoses. These can cause the hose to crack and lead to leaks and water damage. Consult the cleaning instructions in section 8: Frequently Asked Questions.

10 Troubleshooting

	PROBLEM	POSSIBLE CAUSES	POSSIBLE SOLUTIONS
1	My roommates, friends, loved ones won't stop using my TUSHY.	TUSHY's awesomeness	Buy them one for their birthday.
2	There is leaking from the TUSHY body or hose connections.	<ol style="list-style-type: none"> 1. The black rubber gasket(s) are not properly installed on the hose or adapters. 2. The tank adapter threads were cross-threaded or stripped during installation. 3. The TUSHY or hose may need to be replaced (very rare). 	<ol style="list-style-type: none"> 1. Make sure that the black gasket(s) are properly installed on both ends of the Flexible TUSHY Hose, the Brass Mini Adapter & Polyurethane Tube, and the Tank Adapter Brass Mini Adapter. 2. Contact us to request a replacement adapter. 3. Contact us to request a replacement part or TUSHY.
3	There's no access to cool water next to my toilet.	<ol style="list-style-type: none"> 1. You have a flush-o-meter or commercial toilet. 2. You have a wall-mounted toilet or a unique plumbing situation that doesn't allow you to connect at the water valve at the wall. 	<ol style="list-style-type: none"> 1. If you know the flushometer kit will work for you, you can purchase it on our Spare Parts page at hellotushy.com/parts. 2. Visit hellotushy.com/sinkconnect for guidance on how to set TUSHY up with your sink connection instead!
4	The 3/8" mini adapter for TUSHY Oasis doesn't fit well on my sink's warm water connection.	<ol style="list-style-type: none"> 1. We bet you live in California where sometimes the connection is 1/2" rather than the US standard. 2. We bet you live in Europe where sometimes the connection is a G3/8 thread instead of the US standard. 3. We bet you have a unique plumbing setup. 	<ol style="list-style-type: none"> 1. Purchase the 1/2" Metal Adapter on our Spare Parts page at hellotushy.com/parts. 2. Purchase the TUSHY G3/8 European Adapter on our Spare Parts page at hellotushy.com/parts. 3. Contact our customer support at install@hellotushy.com so we can get you set up!

10 Troubleshooting

	PROBLEM	POSSIBLE CAUSES	POSSIBLE SOLUTIONS
5	Never have I ever removed a toilet seat. Help.	Your existing toilet seat might have special quick-release mounts.	Simply unscrew the bolts fastening the quick-release mounts to the toilet. Flip to page 19 for a visual aid!
6	I can't remove the Oasis from my toilet.	You're not a bidet engineer.	Press the Quick Release Button on the right side (if you're facing the toilet) and pull the bidet toward you.
7	I can't remove the bidet seat or lid from the Oasis.	You're human — and probably a visual learner.	Scan the QR code below for a helpful toot-orial!
8	Lid or Seat do not stay up.	Tank lid is preventing lid or seat from reaching vertical position.	Shift the TUSHY forward. To move forward, remove the TUSHY from the Mounting Plate by pressing the Quick Release button on the right hand side and pull the TUSHY away from the tank. Then, loosen the Mounting Bolts and slide the Mounting Plate forward until lid/seat stay up and then tighten bolts.



Scan for more troubleshooting support and video tutorials.

11 One Year Limited Warranty

1. TUSHY warrants this product to be free from defects in materials and workmanship under conditions of normal use for a period of one (1) year from the date of purchase. This warranty is extended only to the original purchaser and is not transferable if the original purchaser sells or otherwise transfers the product. TUSHY may require proof of purchase to determine whether a claim falls within the warranty period.

2. To report any product issues and to open a claim under the warranty, contact TUSHY at warranty@hellotushy.com. TUSHY will reach out to you to attempt to help resolve the issue.

3. If a defect covered by this warranty arises, TUSHY's obligations under this warranty are limited to repair or replacement, at TUSHY's option, provided that such products were used in accordance with the instructions. Replacement may be of the same or similar product at TUSHY's discretion and based on availability. TUSHY reserves the right to inspect the product to confirm that the issue is covered by this warranty.

4. TUSHY is not responsible for the cost of return shipping of this product.

5. This warranty does NOT apply to:

- Damage or loss that occurs during shipment.
- Damage, loss, or injury resulting from negligent or improper use or the user's failure to follow instructions and safety warnings.
- Damage or loss resulting from modification of the product.
- Damage or loss resulting from normal "wear and tear" of the product.
- Damage based on claims of personal injury or property damage, including, but not limited to, claimed damages that are incidental, or consequential in nature.

6. THIS WRITTEN WARRANTY IS THE ONLY WARRANTY MADE BY TUSHY. REPAIR OR REPLACEMENT AS PROVIDED UNDER THIS WARRANTY SHALL BE

THE EXCLUSIVE REMEDY AVAILABLE TO THE PURCHASER.
TUSHY SHALL NOT BE RESPONSIBLE FOR LOSS OF USE OF THE PRODUCT
OR FOR OTHER INCIDENTAL, SPECIAL, OR CONSEQUENTIAL DAMAGES
OR EXPENSES INCURRED BY THE PURCHASER OR A THIRD PARTY, OR FOR
ANY OTHER EXPENSES NOT SPECIFICALLY STATED ABOVE. EXCEPT TO THE
EXTENT PROHIBITED BY THE APPLICABLE LAW, ANY IMPLIED WARRANTIES,
INCLUDING THOSE OF MERCHANTABILITY AND FITNESS FOR A PARTICULAR
PURPOSE, ARE EXPRESSLY LIMITED TO THE DURATION OF THIS WARRANTY.
SOME STATES DO NOT ALLOW LIMITATIONS, SO THE ABOVE LIMITATION AND
EXCLUSION MAY NOT APPLY TO YOU.

7. This warranty gives you specific legal rights, and you may also have other
rights which vary from state to state.



YOUR MAJESTY,
YOUR THRONE AWAITS

12 Contact Information: The TUSHY Poo-Rus

We bend over backwards for your backside. Find a helpful bidet concierge every day at hellotushy.com — chat with a real pooping human!

Support Center

Self-service more your thing?

Visit hellotushy.com/support

Text Us

Keep us in your back pocket!

Text MYTUSHY to 794-54 (US only) or 1 (888) 599-8926 (Canada only)

EMAIL US

Say Hi!

Comments! Compliments! Butt puns!

hello@hellotushy.com

Have General Qs?

i.e. shipping options, product availability:

questions@hellotushy.com

Need a Hook-up With the Hook-Up?

Install help, spare parts, and troubleshooting:

install@hellotushy.com

Subscriptions

Change address, change frequency, or cancel by logging in at hellotushy.com

Returns

Send it back?! OK, I guess.

hellotushy.com/returns

@hellotushy   

OASIS IM V2