

[Skip to content](#)

Manuals+

User Manuals Simplified.



WELLTURN F800 GPS Outdoor Wireless Dog Fence System User Guide

June 11, 2022 June 11, 2022 [Leave a comment on WELLTURN F800 GPS Outdoor Wireless Dog Fence System User Guide](#)

[Home](#) » [WELLTURN](#) » WELLTURN F800 GPS Outdoor Wireless Dog Fence System User Guide 

WELLTURN F800 GPS Outdoor Wireless Dog Fence System User Guide



Contents [hide](#)

[1 HOW IT WORKS](#)

[2 QUICK OPERATING INSTRUCTIONS](#)

[3 DESCRIPTION OF PRODUCTS](#)

[4 PRODUCT PARAMETERS](#)

[5 DESCRIPTION OF BUTTONS](#)

[6 DESCRIPTION OF SCREEN ICONS](#)

[7 PRODUCT CHARGING AND INSTALLATION OF CONTACT POINTS COMPONENTS](#)

[8 STATIC STIMULATION TEST](#)

[9 FUNCTION OPERATION](#)

[10 WEARING PRECAUTIONS](#)

HOW IT WORKS

Working principle of F800 outdoor GPS wireless fence:

1. The center point and the safe radius distance are set through GPS satellite positioning, and your pet can move freely within the set safe range.



Beyond the radius range

Within the radius range

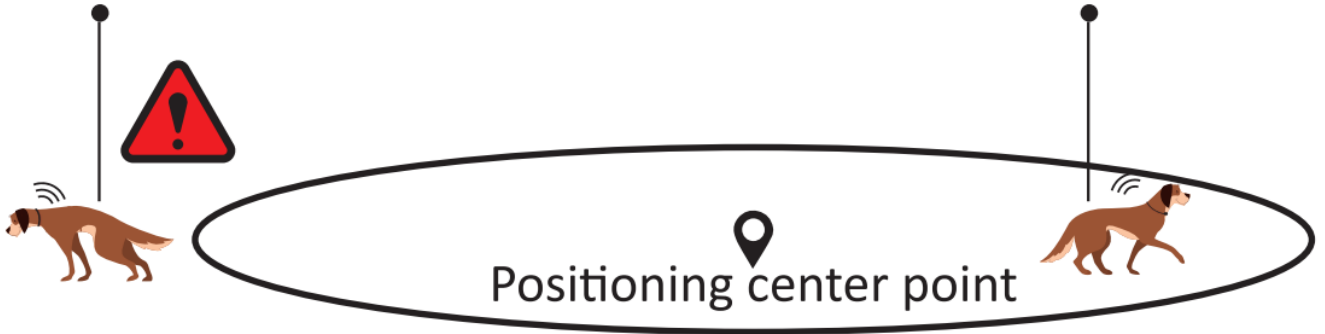

2. When your pet is beyond the set safe distance range, the product will be triggered to work, giving tone, vibration and static stimulation warning; when your pet returns to the set safe distance range, the product will stop the punishment.
3. In essence, you should train your pet how to turn off the product punishment.

QUICK OPERATING INSTRUCTIONS

1. Turn on/off

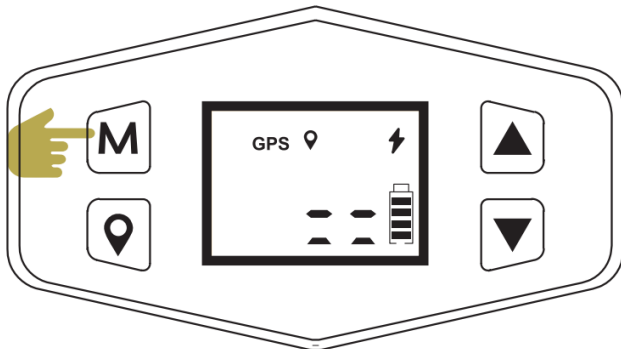

- Press and hold the M button for about 3S to turn on/off the product

2. GPS signal searching

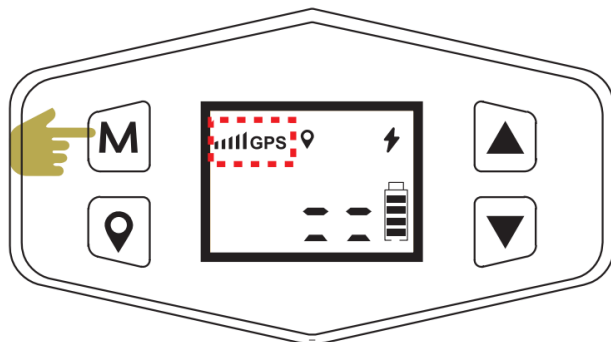

- Turn on the product to enter the GPS search signal state, and the screen displays GPS and flashing = = icon. After the signal is found, the GPS shows a different number of signal bars, and it is recommended to use the product at full signal bars.

3. Center point positioning

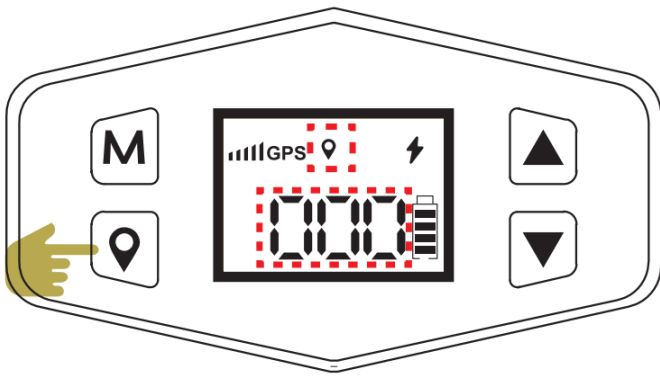

- It is necessary to position the center point before the first use. When the screen goes on, press and hold the positioning button, and the screen displays the positioning icon and 000, indicating that the positioning is successful. (If there is no positioning icon and 000, the positioning is not successful)

4. Automatic memory function

- The automatic memory function enables the product to automatically recall the center-point and the safe radius distance of the last positioning each time when turned on, and it is necessary to reposition the center point and the safe radius distance if the training place is changed.
- Turn on

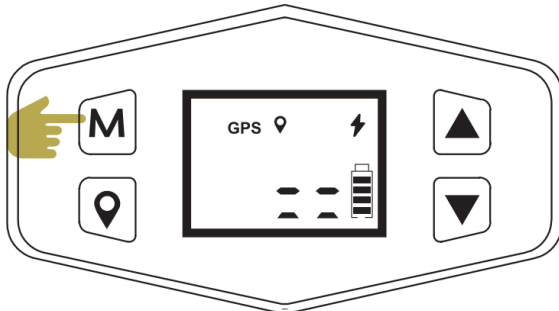

- Automatically remember the center point and the safe radius distance of the last positioning, and reposition the center point and the safe radius distance if the place is changed

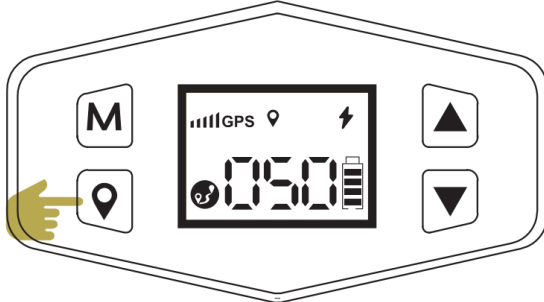

5. Safe radius distance setting

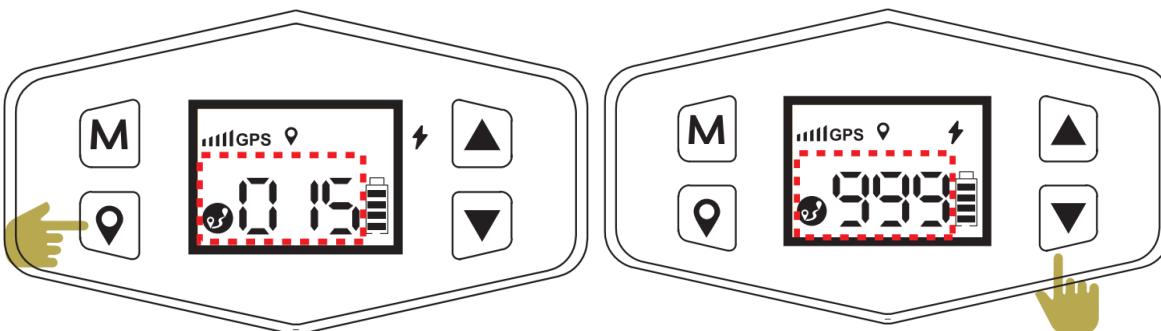

- After the positioning is successful, click the positioning button again, the distance icon and the distance number flash on the screen, and then press the up/down button to adjust to the desired safe radius distance (15-999 yards), the distance is automatically confirmed after 55, or click the positioning button to confirm it manually.

The minimum radius distance is 15 yards, and the maximum radius distance is 999 yards (1 yard = 0.9144 meters)

6. How to measure the distance

- Please leave the center point after both center point and maximum radius distance 999 yards are set up, then walk to the boundary where you want to stop at, now the distance shown on the screen is the yards away from the center point, and this yard is the most reasonable safe radius distance.

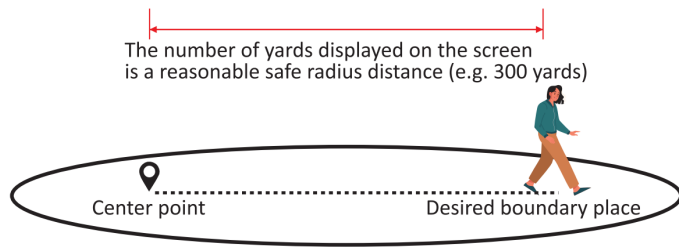

After completing this step of setting, you can put the product on the dog and start using it.

The F800 outdoor GPS wireless fence only needs a collar receiver (transmitter not needed) to work with GPS positioning technology, and can cover the outdoor area with a radius up to 999 yards. There are two training modes, i.e. automatic mode and fixed mode, and adjustable 6 levels of separate vibration and static stimulation, which makes it easier to train your dog.

DESCRIPTION OF PRODUCTS

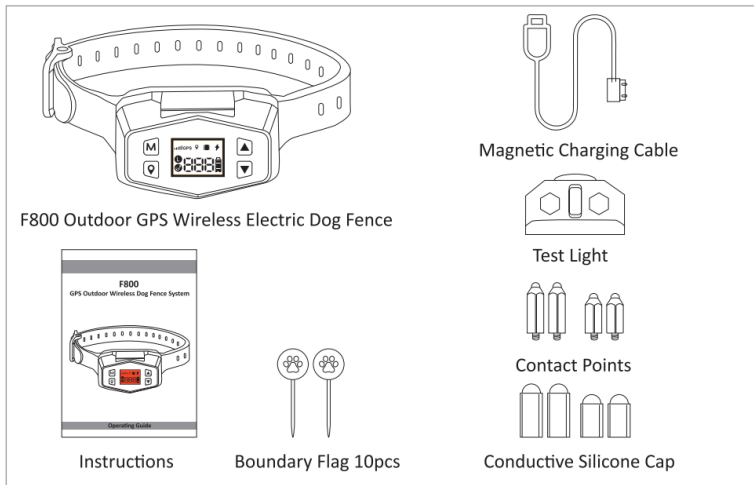

PRODUCT PARAMETERS

Pet weight: over 20 lbs (not suitable for small-sized dogs)
Collar size: 8.46-23.82in
Collar material: TPU Working mode: automatic mode + fixed mode
Working level: 6 levels Charging mode: magnetic charging
Battery capacity: 1500mAh
Product material: ABS Waterproof grade: IPX7

DESCRIPTION OF BUTTONS

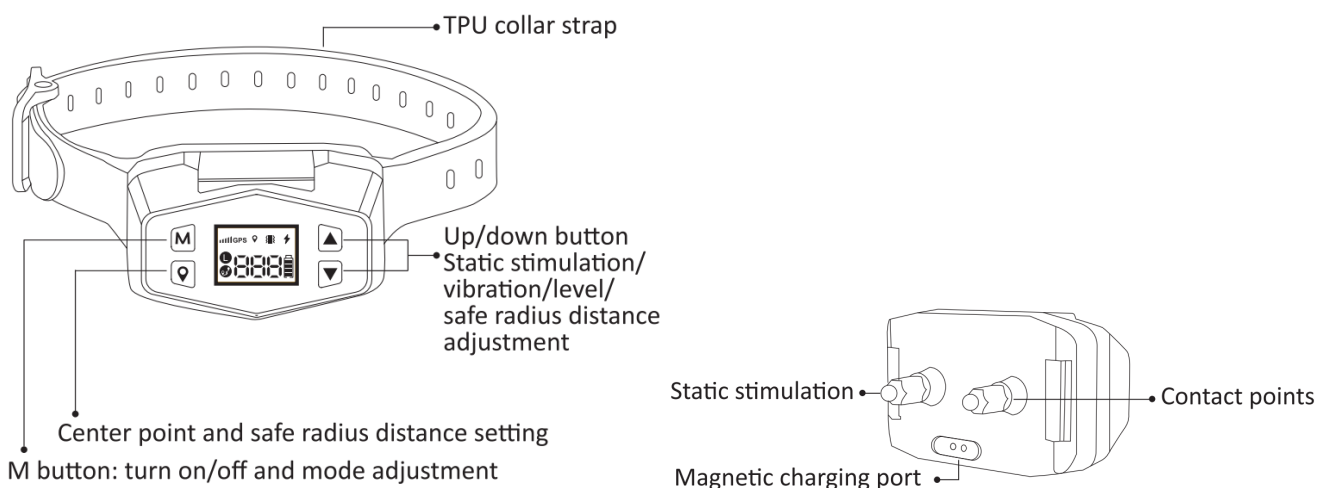

DESCRIPTION OF SCREEN ICONS

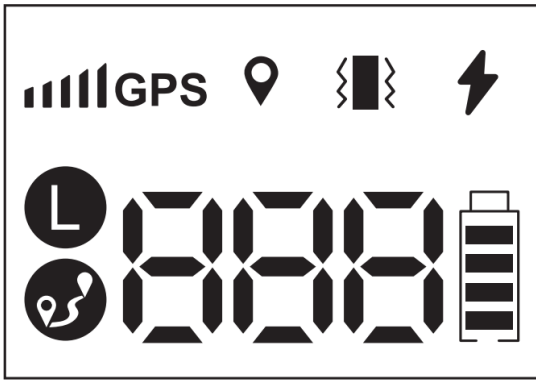

GPS signal icon: The stronger the GPS signal, the more the signal bars



Positioning icon: When the center point is positioned successfully, this icon is displayed; when it is not positioned, the icon flashes, and the product beeps for 55



Battery power icon: It is displayed in four bars when fully charged.



Vibration mode: If this icon is on, it indicates that the product is currently in vibration mode setting



Static stimulation mode: If this icon is on, it indicates that the product is currently in static stimulation mode setting



L level strength icon: It is the level icon displayed during operation



Safe radius distance icon: When the distance icon is displayed, the number represents the currently set safe distance radius, which is not displayed when it is not set



Waiting icon: When it flashes, it indicates that the GPS search is in progress; when it does not flash, it indicates an undetermined center point or a sleep state.



No signal icon: If the product still does not find the GPS signal within 6 minutes, it goes into the deep sleep state, and the GPS will be suspended to reduce the power consumption.



Protection mode: After every 6 levels of punishment, the product enters the lmin protection mode, the screen displays P and beeps, and this mode lasts for one minute to enter the next cycle.

PRODUCT CHARGING AND INSTALLATION OF CONTACT POINTS COMPONENTS

Tips: Please fully charge the product before use

Charging: Contact the magnetic charging cable port with the charging port, and the product can be charged once they are adsorbed to each other. When charging, the red light is always on, and the green light is always on when fully charged.

1. Install the contact points.

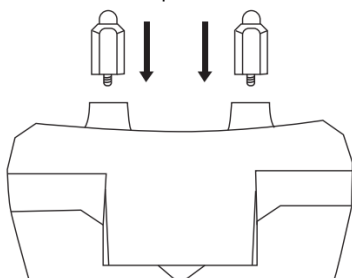

2. Tighten the static stimulation column with the test light.

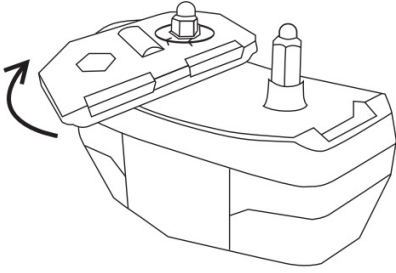

3. Install the conductive silicone cap.

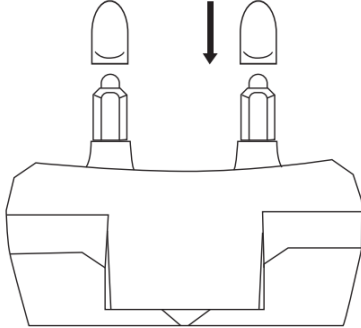

STATIC STIMULATION TEST

Test on Static stimulation:

Firstly adjust the product to Fixed mode with level 6 of static stimulation, then put the test light on the contact points, and go beyond the radius range, the test light goes on when static works.

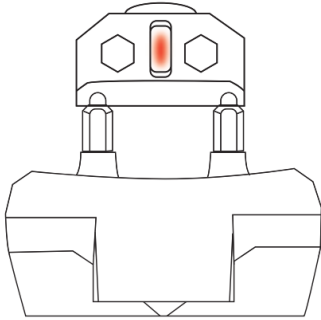

FUNCTION OPERATION

1. Turn on/off

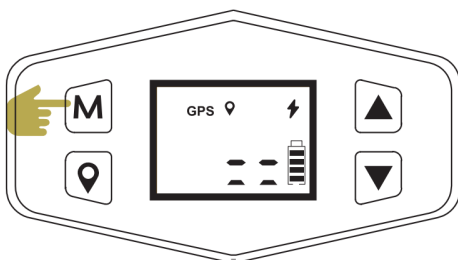

- Press and hold for 3S to turn on the product: It beeps once, and the screen goes on Press and hold for 35 to turn off the product: It beeps twice, and the screen goes out

2. GPS signal searching

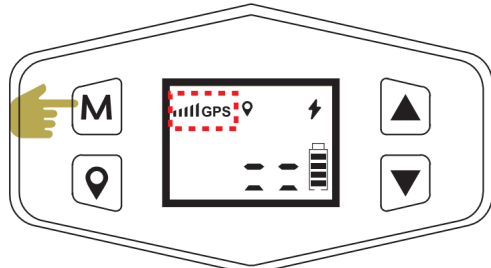

- Turn on the product to enter the GPS search signal state, and the screen displays GPS and flashing = = icon. After the signal is found, the GPS shows a different number of signal bars, and it is recommended to use the product at full signal bars.

3. Center point positioning

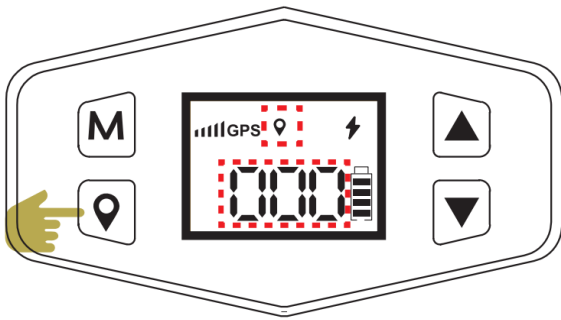

- It is necessary to position the center point before the first use. When the screen goes on, press and hold the positioning button, and the screen displays the positioning icon and 000, indicating that the positioning is successful. (If there is no positioning icon and 000, the positioning is not successful)

4. Automatic memory function

- The automatic memory function enables the product to automatically recall the center-point and the safe radius distance of the last positioning each time when turned on, and it is necessary to reposition the center point and the safe radius distance if the training place is changed.
- Turn on

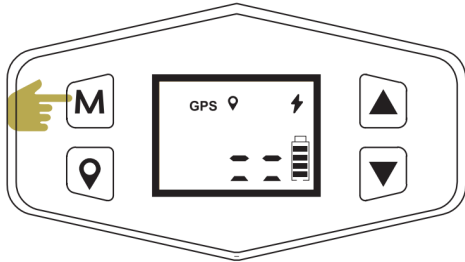

- Automatically remember the center point and the safe radius distance of the last positioning, and reposition the center point and the safe radius distance if the place is changed

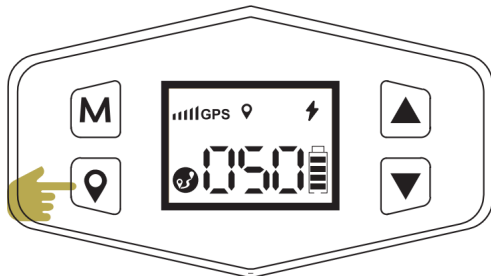

5. Safe radius distance setting

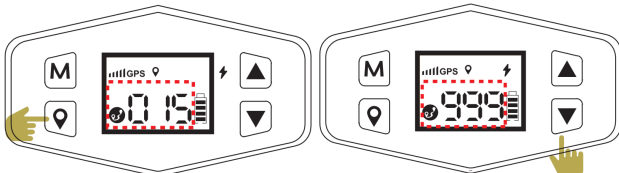

- After the positioning is successful, click the positioning button again, the distance icon and the distance number flash on the screen, and then press the up/down button to adjust to the desired safe radius distance (15-999 yards), the distance is automatically confirmed after 55, or click the positioning button to confirm it manually. The minimum radius distance is 15 yards, and the maximum radius distance is 999 yards (1 yard = 0.9144 meters)

Press the up/down button to adjust the safe radius distance: press and hold for less than 3 seconds to increase the distance with an increment of 1 yard, and then increase with an increment of 10 yards.

6. How to measure the distance

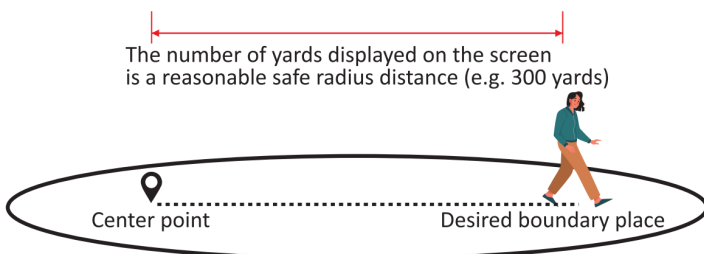

- Please leave the center point after both center point and maximum radius distance 999 yards are set up, then walk to the boundary where you want to stop at, now the distance shown on the screen the yards away from the center point, and this yard is the most reasonable safe radius distance.

7. How to adjust Vibration and Static stimulation

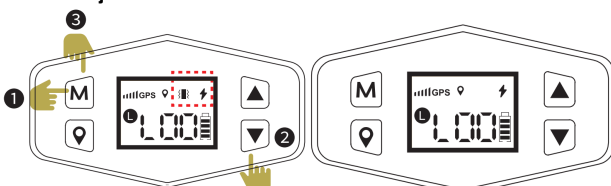

- After turning on the product, press the M button when the screen is on, and the static stimulation/vibration icon flashes. Select the static stimulation/vibration icon through the up/down button, and then press the M button to confirm the flashing mode, and only the confirmed icon is displayed on the screen after confirmation.

8. How to adjust Automatic mode and Fixed mode

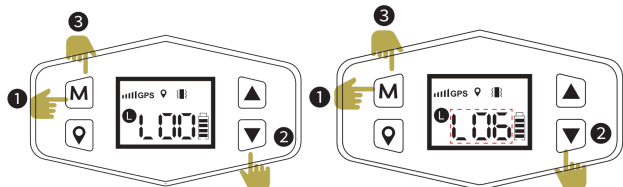

Automatic mode L00

Fixed mode L01-L06

- Training mode adjustment: In case of mode adjustment, 100 represents the automatic mode, and L01-L06 represent the fixed mode. After confirming the static stimulation or vibration mode, press the M button, the L icon flashes to enter the level adjustment, adjust L00-L06 through the up/down button, and then press the M button for confirmation. (The factory default setting is automatic mode + static stimulation)

Description of Mode Levels

Level state Static stimulation mode Remarks



Level 2

Automatic/fixed mode

Level 3

Level 4

Level 5

Level 6

Level state Vibration mode

Level 1

Level 2

The automatic mode automatically works from level 1 to level 6; the fixed mode needs to be set manually

Automatic/fixed mode

Level 3 

Level 4 

Level 5 

Level 6 

9. Description of p protection mode

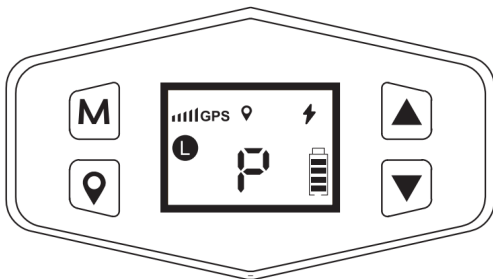

1. When your pet goes beyond the set safe radius distance range, the product will be triggered to work and give the first round of tone/vibration/static stimulation warning (there will be 6 punishments if your pet does not return to the safe distance, and the product will enter the protection mode after 6 punishments and make a tone prompt for one minute to stop the vibration and static stimulation punishment).
2. After the end of the first round of protection mode, if your pet has not returned to the set safe distance range, the product will give the second round of punishment (6 punishments, after which the tone will last until the battery is dead or your pet returns to the safe radius).

- in any case, after your pet returns to the set safe distance range, the product will stop the punishment.

WEARING PRECAUTIONS

Please read and follow the instructions in this Operating Guide.

- A collar worn for too long or made too tight on the pet's neck may cause skin damage ranging from redness to pressure ulcers; this condition is commonly known as bed sores.
- Avoid leaving the collar on your pet for more than 12 hours per day.
- When possible reposition the collar on the pet's neck every 1 to 2 hours. Check the fit to prevent excessive pressure; follow the instructions in this Operating Guide. Never connect a lead to the electronic collar; it will cause excessive pressure on the contacts.
- When using a separate collar strap for a lead, don't put pressure on the electronic collar.
- Wash your pet's neck area and the contacts of the collar weekly with a damp cloth. Examine the contact area daily for signs of a rash or a sore.
- If a rash or sore is found, discontinue use of the collar until the skin has healed. If the condition persists beyond 48 hours, see your veterinarian.
- These steps will help keep your pet secure and comfortable. Millions of pets are comfortable while they wear stainless steel contacts. Some pets are sensitive to contact pressure. You may find after some time that your pet is very tolerant of the collar. If so, you may relax some of these precautions. It is important to continue daily checks of the contact area. If redness or sores are found, discontinue use until the skin has fully healed.

WEARING METHOD

1. Please follow these steps for wearing: (incorrect wearing will affect the effect)
 1. **A.** Make sure the receiver is off, and keep the dog in a comfortable standing position.
 2. **B.** Place the receiver in the middle of the dog's neck with the switch button facing up, and check the tightness of the receiver collar. The standard is that there is room for a finger between the collar and the dog's neck. Wearing too loose or too tight will affect the normal operation of the product.
 3. **C.** If installed correctly, the receiver/collar will not move on the dog. In this case, the contact point may rub against the skin and cause irritation. If the receiver/collar is too tight, the dog may have difficulty in breathing.
 4. **D.** If the collar strap is too long, it can be cut off with scissors.

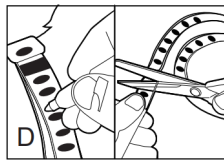
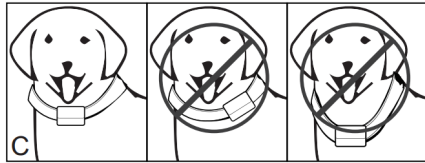
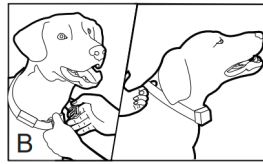
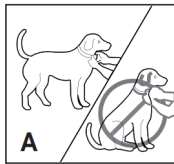

Documents / Resources



[WELLTURN F800 GPS Outdoor Wireless Dog Fence System](#) [pdf] User Guide
F800, 2ATOXF800, GPS Outdoor Wireless Dog Fence System, F800 GPS Outdoor Wireless Dog Fence System

Related Manuals / Resources



[Polar Grit X Outdoor Watch with GPS User Manual](#)

Polar Grit X Outdoor Watch with GPS User Manual - Optimized PDF Polar Grit X Outdoor Watch with...

[SOLIOM Outdoor Wireless Solar Camera S800 V1 User Manual](#)

Outdoor Wireless Solar Camera S800 V1



[SimpliSafe CM3000 Wireless Outdoor Security Camera User Guide](#)

GETTING STARTED Use the included cable to charge your battery Charging takes around 5 hours. The 3 LEDs...



[PHILIPS Inara hue Personal Wireless Outdoor Wall Lighting User Manual](#)

PHILIPS Inara hue Personal Wireless Outdoor Wall Lighting Overview Installation STEP-1 STEP-2 STEP-3 STEP-4 STEP-5 STEP-6 STEP-7 STEP-8...

Leave a comment

Your email address will not be published.

Comment

Name

Email

Website

Save my name, email, and website in this browser for the next time I comment.

[Manuals+](#)

- [home](#)
- [privacy](#)