



**SINGER®**

| momento

# User Guide

Square Press

## **IMPORTANT SAFETY INSTRUCTIONS**

When using an electrical appliance, basic safety precautions should always be followed, including the following:

Read all instructions before using this product.

Keep the instructions at a suitable place close to the machine. Make sure to hand them over if the machine is given to a third party.

### **DANGER — TO REDUCE THE RISK OF ELECTRIC SHOCK:**

The plug on the power supply is used as the disconnect device. The machine should never be left unattended when plugged in. The electrical socket, to which the machine is plugged in should be easily accessible. Always unplug this machine from the electric outlet immediately after using and before cleaning, removing covers, lubricating or when making any other user servicing adjustments mentioned in the instruction manual.

### **WARNING — TO REDUCE THE RISK OF FIRE, ELECTRICAL SHOCK, OR INJURY:**

- This appliance is intended for use by adults. The appliance can be used with adult supervision by (i) children aged from 8 to 12 years and (ii) persons with reduced physical, sensory or mental capabilities or lack of experience and knowledge if they have been given instruction concerning use of the appliance in a safe way and understand the hazards involved. Cleaning and user maintenance shall not be made by children without supervision. It is not allowed for anyone to play with the machine. Children up to 8 years are not allowed to use the machine.
- To reduce the risk of contact with hot water emitting from steam vents, check appliance before each use by holding and facing it away from body and operating steam button.
- Unwind and straighten power cord and remove cardboard soleplate cover before use.
- This appliance is intended for household and residential use only. This product is not approved for commercial applications. Use appliance only for its intended use.
- To protect against a risk of electric shock, do not immerse the appliance in water or other liquids. The appliance should always be turned off before plugging or unplugging from outlet.
- Always disconnect appliance from electrical outlet when filling with water emptying or when not in use.
- Do not allow cord to touch hot surfaces. Let the press cool completely before putting away. Coil the cord loosely around the press when storing.
- Do not operate appliance with a damaged cord or if the appliance has been dropped or damaged.
- If the appliance or power cord is damaged, it must be replaced by manufacturer, its service agent, or similarly qualified technician in order to

avoid a hazard.

- To avoid the risk of electric shock, do not disassemble the appliance. Take, or ship it to a qualified service person for examination and repair. Incorrect reassembly or repair can cause a risk of fire, electric shock, or injury to persons when appliance is used.
- Burns can occur from touching hot metal parts, hot water or steam. Use caution when you turn the steam press upside down – there may be hot water in the tank.
- Never open the water tank door while the appliance is in use. The steam pressure could result in burns. Only open the door when the press is cool and unplugged.
- To reduce the likelihood of circuit over load, do not operate another high wattage appliance on the same circuit.
- If an extension cord is absolutely necessary, a cord with an ampere rating equal to or greater than the maximum rating of the press shall be used. A cord rated for less amperage can result in a risk of fire or electric shock due to overheating. Care shall be taken to arrange the cord so that it cannot be pulled or be tripped over.
- The press should be used on a stable surface and placed on a stable surface. When placing the press on its heel, the press must be rested on a stable surface.
- Never drop or insert an object into any opening (electrical or other), and do not use if one of the openings is blocked.
- Do not use outdoors.
- Do not operate where aerosol (spray) products are being used or where oxygen is being administered.
- Clean the appliance only with a dry or slightly damp cloth.
- Use only approved and supplied parts and accessories.
- Use of any other kind of accessory is not recommended.
- The press is not to be used if it has been dropped, if there are visible signs of damage or if it is leaking.
- Read and follow all important notices in this guide.
- Align the press's soleplate so it is secured onto the stand which is designed to accurately fit the press's soleplate. Failure to do so may result in burns to surfaces. Do not place stand on an uneven surface as this may result in burns to surfaces that come into contact with the soleplate.
- To reduce the risk of electric shock, this product has a polarized plug (one blade is wider than the other). This plug is intended to fit in a polarized outlet only one way. When the plug does not fit fully in the outlet, reverse the plug. When it still does not fit, contact a qualified electrician to install the proper outlet. Do not change the plug in any way.

## **IMPORTANT INSTRUCTIONS FOR APPLIANCES WITH SHORT POWER-SUPPLY CORDS:**

- a. A short power-supply cord (or short detachable power-supply cord) is provided to reduce the risks resulting from becoming entangled in or tripping over a longer cord.
- b. Extension cords (or longer detachable power-supply cords) are available and are not prohibited from being used when care is exercised in their use.
- c. When an extension cord is used.
  1. The marked electrical rating of the detachable power-supply cord or extension cord shall be no less than the marked electrical rating of the product.
  2. The longer cord shall be arranged so that it does not drape over the counter-top or tabletop where it is capable of being tripped over, snagged, or pulled on unintentionally, especially by children.

## **SAVE THESE INSTRUCTIONS**

## **INTRODUCTION**

### **Intended Use**

The optimal uses are described in these instructions. This product is not intended for industrial or commercial use

Additional assistance, by region, may be found online at [www.singer.com](http://www.singer.com)

You can find a digital version of this manual online at [www.singer.com](http://www.singer.com)

# Overview

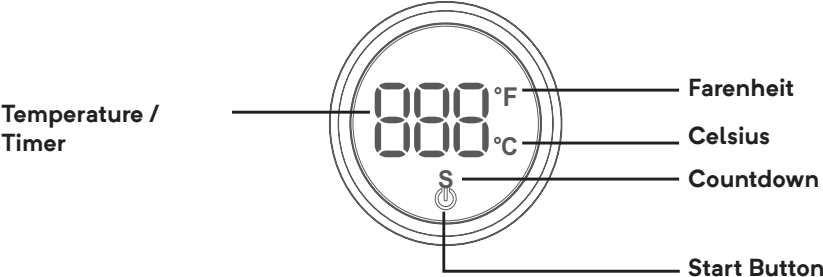
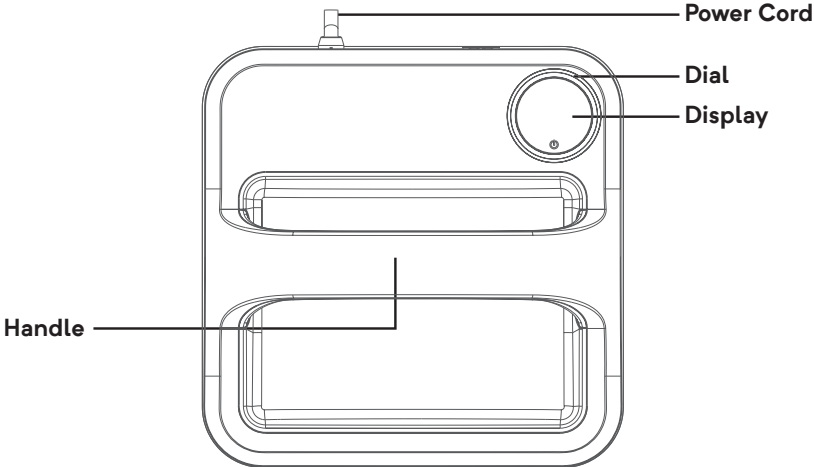

# Accessories list

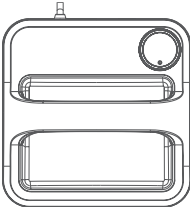

Main machine

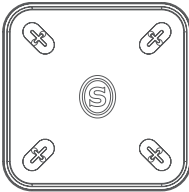

Insulated tray

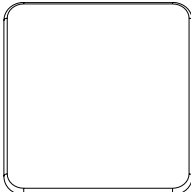

High temperature resistant pressing mat



User manual

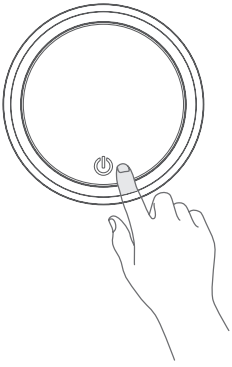

1. **Startup.**  
Plug the machine into a wall outlet and short press the start button to start the machine. Machine will be in standby mode when plugged in until powered on.  
To turn on press the start button.
2. **Shutdown**  
Press and hold the start button for 3s to shut down.
3. **Auto shutdown**  
The machine will automatically shut down if there is no operation within 30 min.

## Temperature Unit Conversion

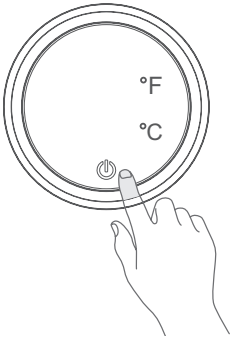

1. In standby mode.
2. Press and hold the start button for 6s.
3. Turn the dial to select the required temperature unit.
4. Short press the start button to start the machine.

## Temperature setting:

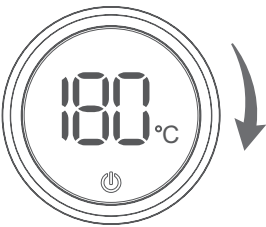

1. Turn the dial half a turn to the right.
2. Enter the temperature setting mode after a beep sound.
3. Turn the dial to the right again to increase the temperature.
4. Turn the dial to the left again to reduce the temperature (-).

## Timer settings:

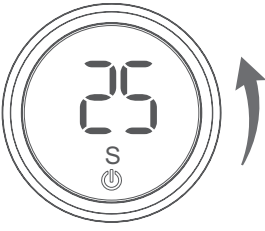

1. Turn the dial half a turn to the left.
2. Enter the timer setting mode after a beep sound.
3. Turn the dial to the right again to increase the time (+).
4. Turn the dial to the left again to decrease time (-).

## Ready to start



1. When ready to use press after machine has reached desired temperature, to start timer press center of display to start the timer.
2. When timer is complete, press center of display to acknowledge timer and stop beep.

## Non-Original Parts and Accessories

The warranty does not cover any defect or damage caused by the use of non-original accessories or parts.

## INTELLECTUAL PROPERTY

SINGER and the Cameo “S” Design are exclusive trademarks of The Singer Company Limited S.à.r.l. or its Affiliates. MOMENTO is an exclusive trademark of Singer Sourcing Limited LLC or its Affiliates. © 2024 The Singer Company Limited S.à.r.l. or its Affiliates. All rights reserved.

*We reserve the right to change the machine equipment and the assortment of accessories without prior notice, or make modifications to the performance or design. Such modifications, however, will always be to the benefit of the user and the product.*



Please note that on disposal, this product must be safely recycled in accordance with relevant National legislation relating to electrical/electronic products. Do not dispose of electrical appliances as un-sorted municipal waste, use separate collection facilities. Contact your local government for information regarding the collection systems available. When replacing old appliances with new ones, the retailer may be legally obligated to take back your old appliance for disposal free of charge.

If electrical appliances are disposed of in landfills or dumps, hazardous substances can leak into the groundwater and get into the food chain, damaging your health and well-being.



## Cleaning and Maintenance

1. Turn off the power button, and unplug from outlet.
2. Some parts may still be hot, don't touch by hand before cooling down.
3. Clean the surface with a damp cloth. Do not use abrasive cleaning balls to scrub to avoid damaging the coating.
4. Wipe the inner and outer surfaces of this product with a soft wrung wet cloth. Do not directly clean this product with water.
5. Before this product is used or stored, all parts must be cleaned, dried with a dry cloth and assembled back to the original positions for next use.

## Basic Product Parameters

<b>Product name:</b>	Heat Press Machine
<b>Heating method:</b>	Electrical heating coil
<b>Rated voltage/frequency:</b>	120V~60Hz
<b>Rated power</b>	670W
<b>Temperature range:</b>	40°C-205°C (104°F-401°F)
<b>Time range:</b>	1-1999s
<b>Model:</b>	momento Square Press
<b>Heating plate size:</b>	12" x 10" / 9" x 9" / 6" x 7"

### **MANUFACTURER**

VSM Group AB, **SVP WORLDWIDE**

Soldatorpsgatan 3, SE-55474 Jönköping, SWEDEN

