

ASTER

KING SINGLE BUNK BED

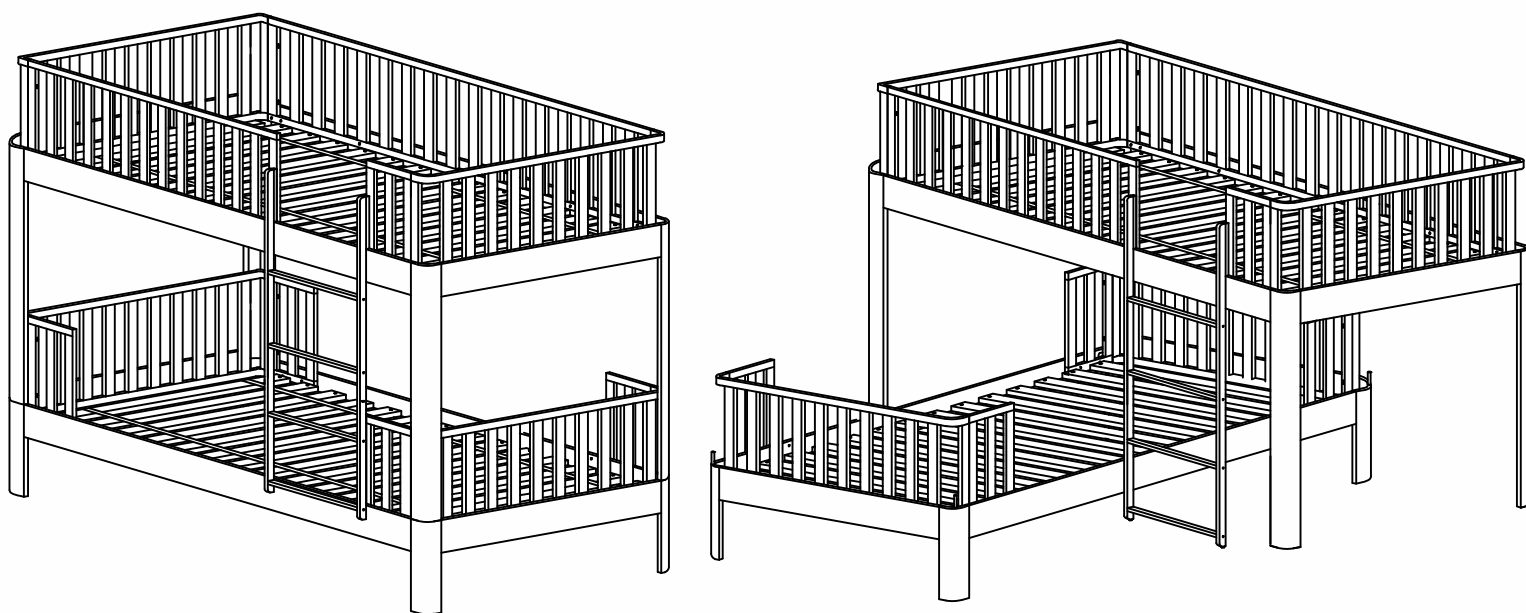





This product can be assembled as one bunk bed or two standalone beds.



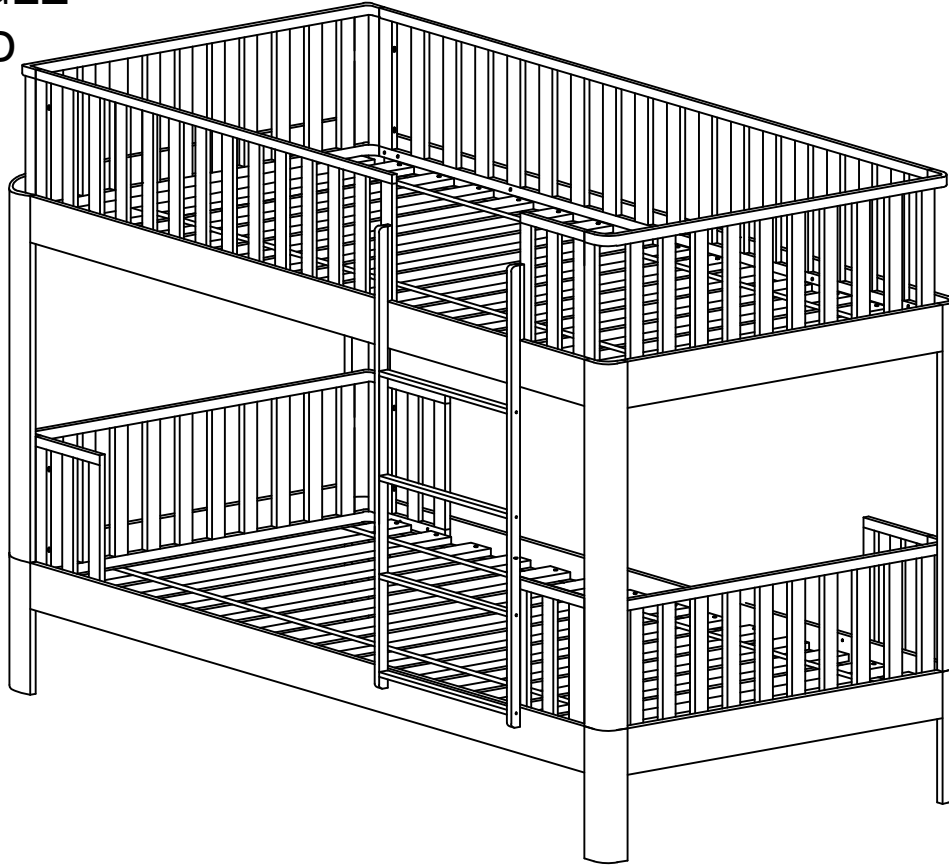





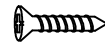

- To assemble as bunk bed, go to the instructions on page 10 after step 13
- To assemble as two standalone beds, go to the instructions on page 12 after step 13
- Please do not throw away any of the packaging or instructions until you have checked all the components and hardware and have successfully completed the assembly
- Before starting the assembly, please spend a short time looking through this leaflet.
- We suggest building your item on a soft surface such as a rug or carpet, or even the packaging this item arrived in. This will help protect the product and your floor!
- Please only use the appropriate tools needed for each task as indicated or mentioned.
- Ensure you have 2 people if your product is heavy or large, or awkward for you.
- Assemble all components loosely until the final stages.
- Keep the assembly tools with the instructions. depending on use, it will be necessary to perform maintenance or upkeep on your product.
- Please keep small pieces out of reach of small children
- If you encounter any issues or concerns before, during or after assembly, be they large, small or strange, please let us know at customer@b2cfurniture.com.au We have a dedicated support team with solutions and remedies ready to put them into action for you.
- Final step, enjoy your furniture!

ASTER

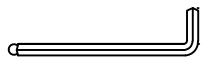
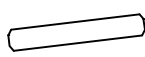
KING SINGLE BUNK BED



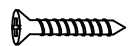



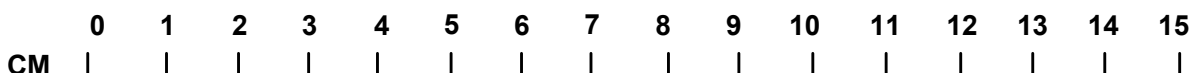



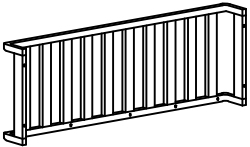

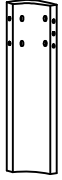

-  M6
-  M8
-  M10

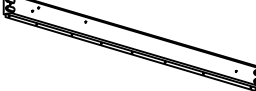
				
JCCA M6 x 60mm	U-Washer	M6 x 13mm	M4 x 32mm	M8 x 30mm
1.(x32)	2.(x32)	3.(x32)	4.(x50)	5.(x28)
				
ALLEN KEY WITH BALL	M9.5 x 105mm	M6 x 20mm	M6 x 50mm	M6 x 35mm
6.(x1)	7.(x4)	8.(x6)	9.(x27)	10.(x31)
				
Adjuster	M4 x 45mm	M6 x 70mm		
11.(x2)	12.(x16)	13.(x3)		

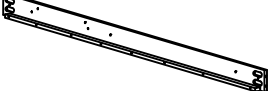
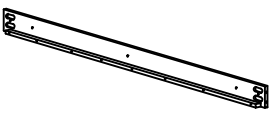
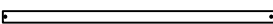
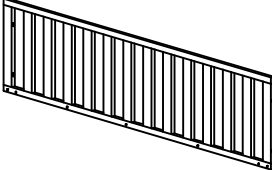
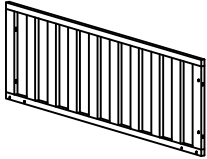

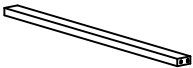
ASTER KING SINGLE BUNK BED

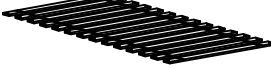
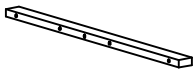
<p>①</p>  <p>A.(x4)</p>	<p>②</p>  <p>B.(x3)</p>	<p>③</p>  <p>C.(x1)</p>	<p>④</p>  <p>D.(x1)</p>	<p>⑤</p>  <p>E.(x4)</p>
<p>⑥</p>  <p>F.(x4)</p>	<p>⑦</p>  <p>G.(x4)</p>	<p>⑧</p>  <p>H.(x1)</p>	<p>⑨</p>  <p>I.(x1)</p>	<p>⑩</p>  <p>J.(x1)</p>
<p>⑪</p>  <p>K.(x1)</p>	<p>⑫</p>  <p>L.(x3)</p>	<p>⑬</p>  <p>M.(x1)</p>	<p>⑭</p>  <p>N.(x1)</p>	<p>⑮</p>  <p>O.(x1)</p>
<p>⑯</p>  <p>P.(x1)</p>	<p>⑰</p>  <p>Q.(x4)</p>	<p>⑰</p>  <p>R.(x2)</p>	<p>⑱</p>  <p>S.(x1)</p>	<p>⑲</p>  <p>T.(x4)</p>

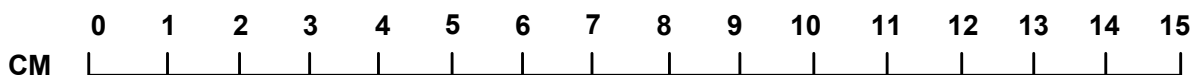

1.

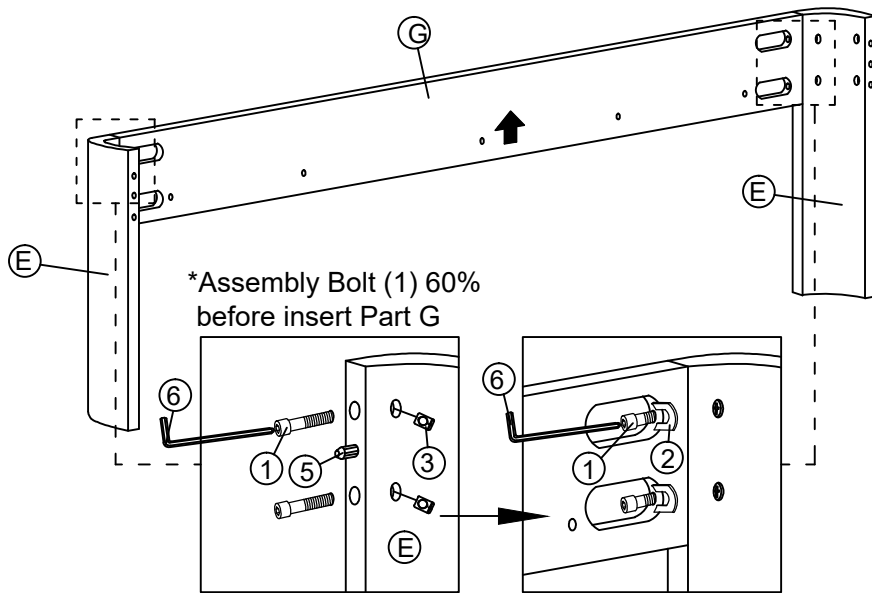

2.

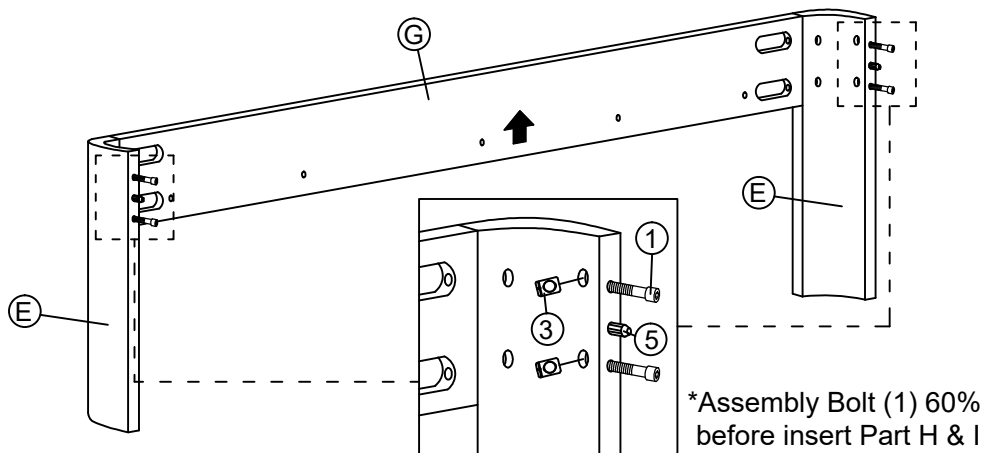

3.

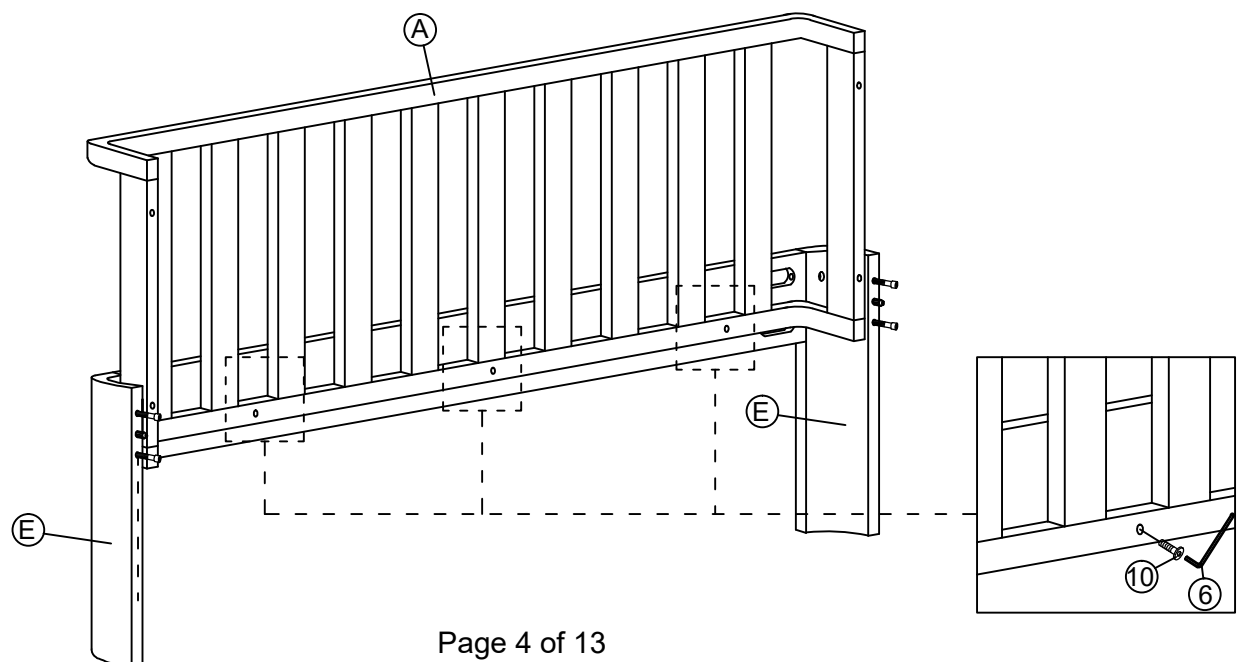

4.

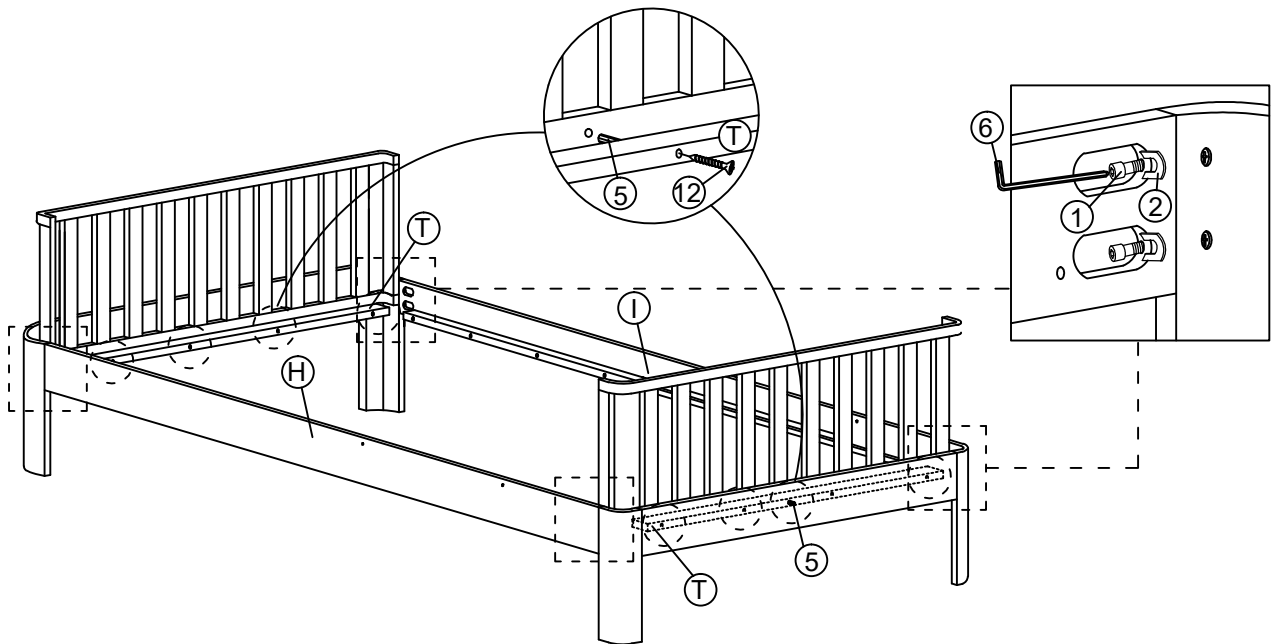

5.

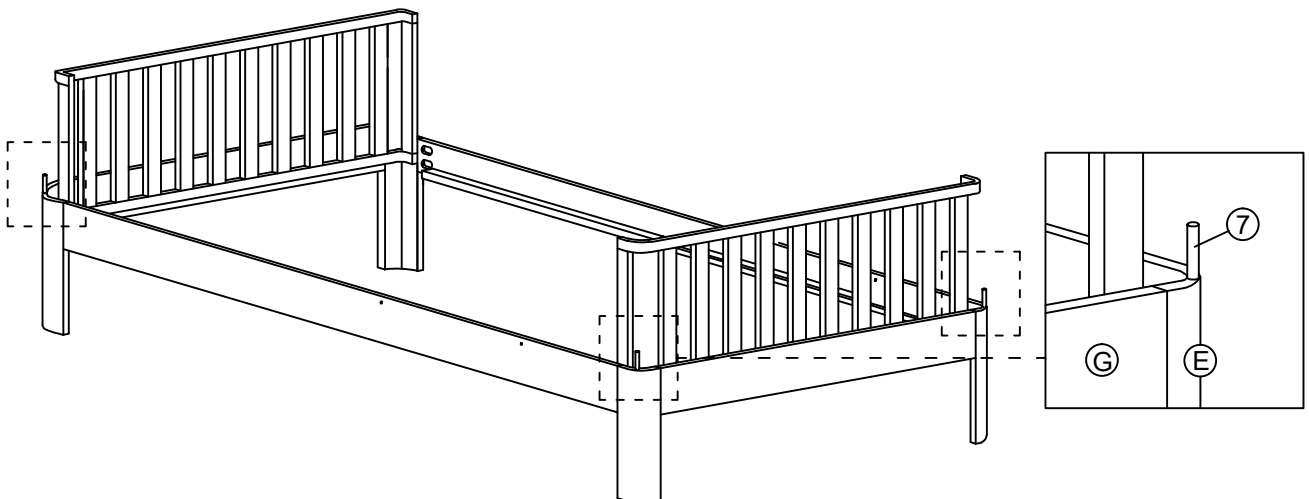

6.

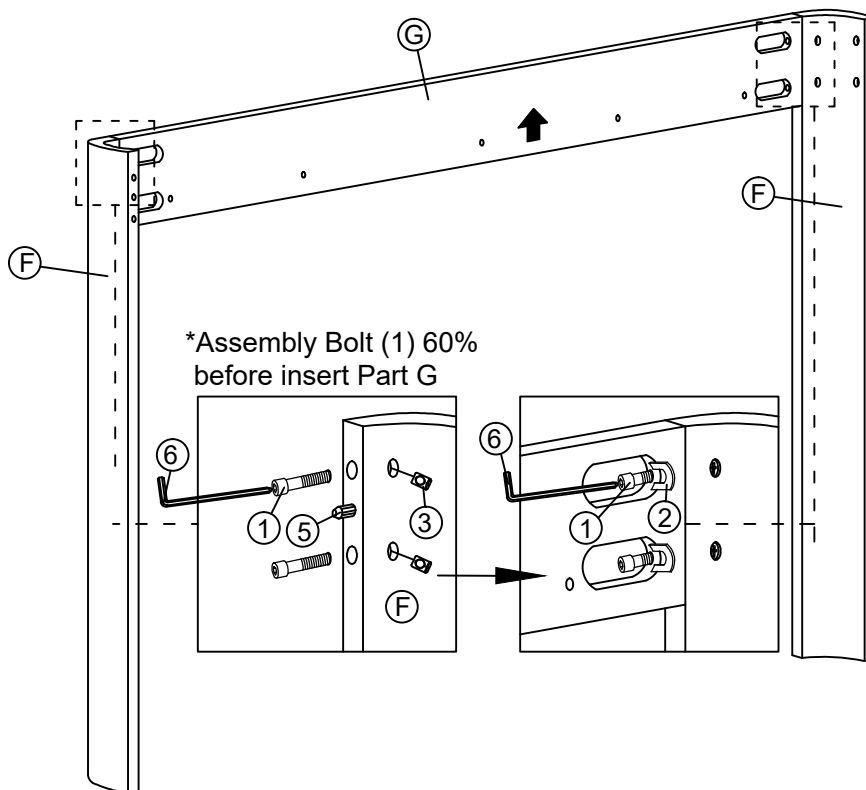

7.

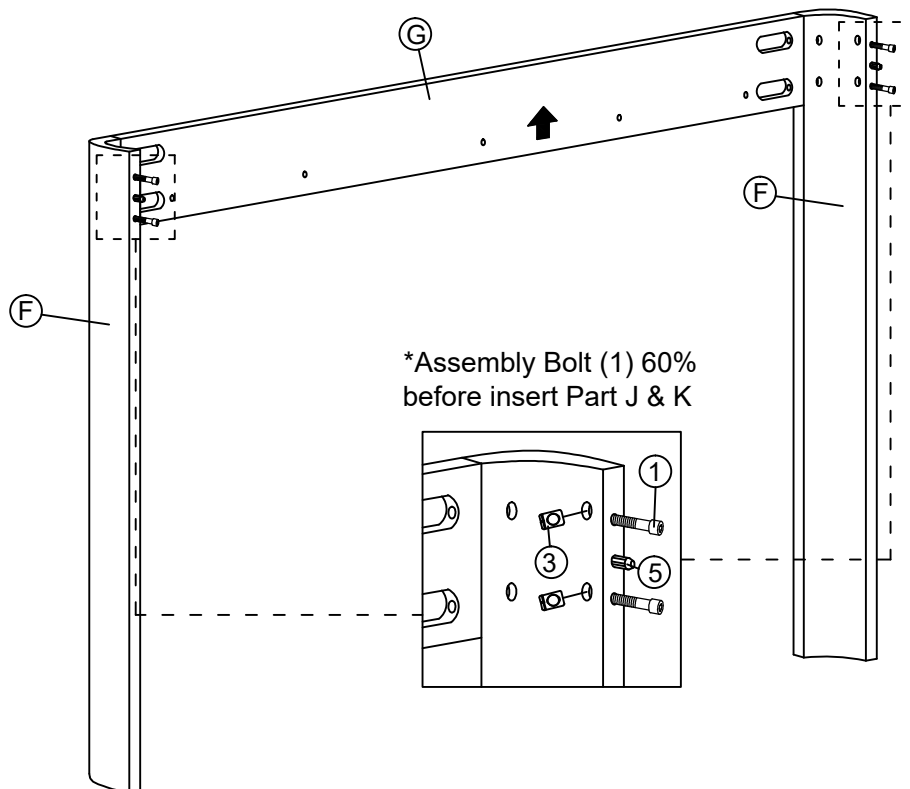

8.

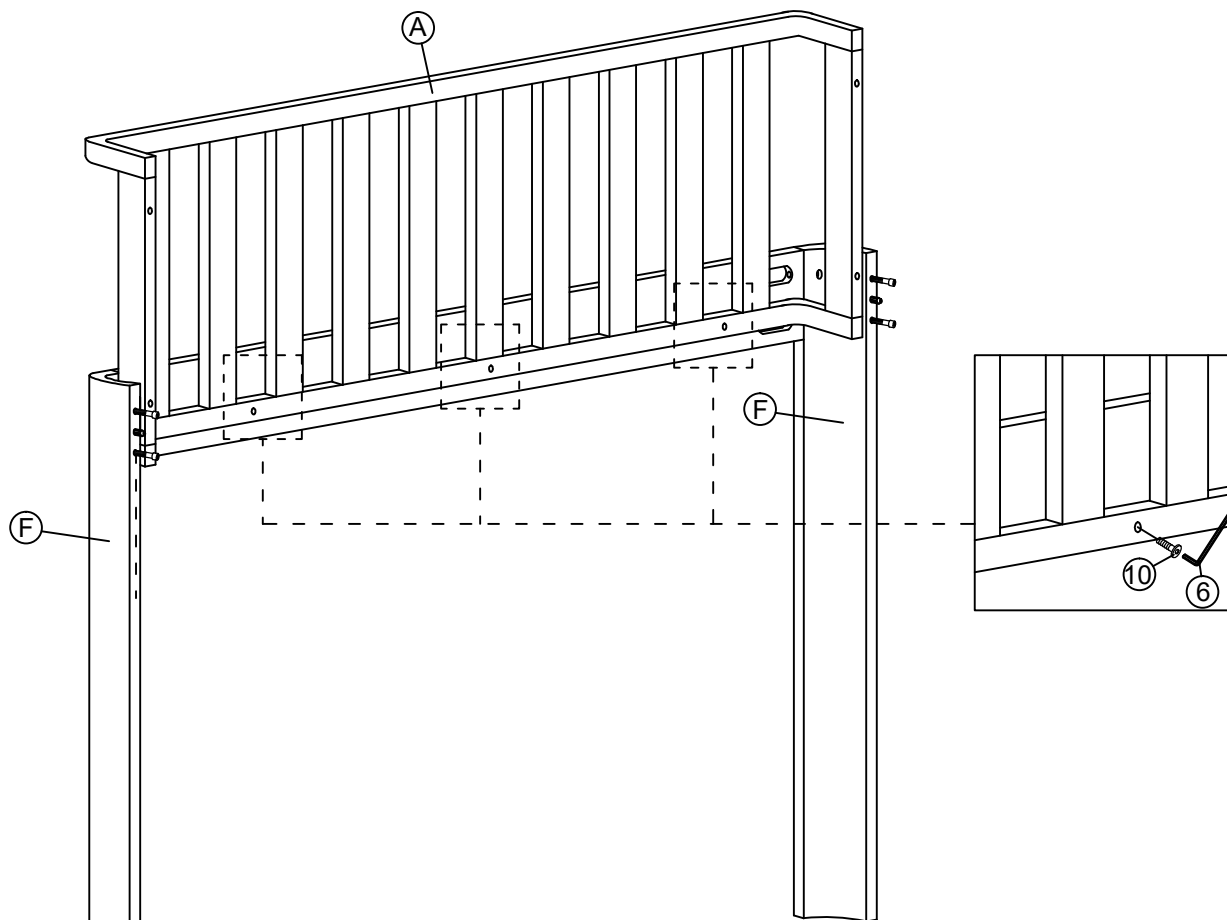

9.

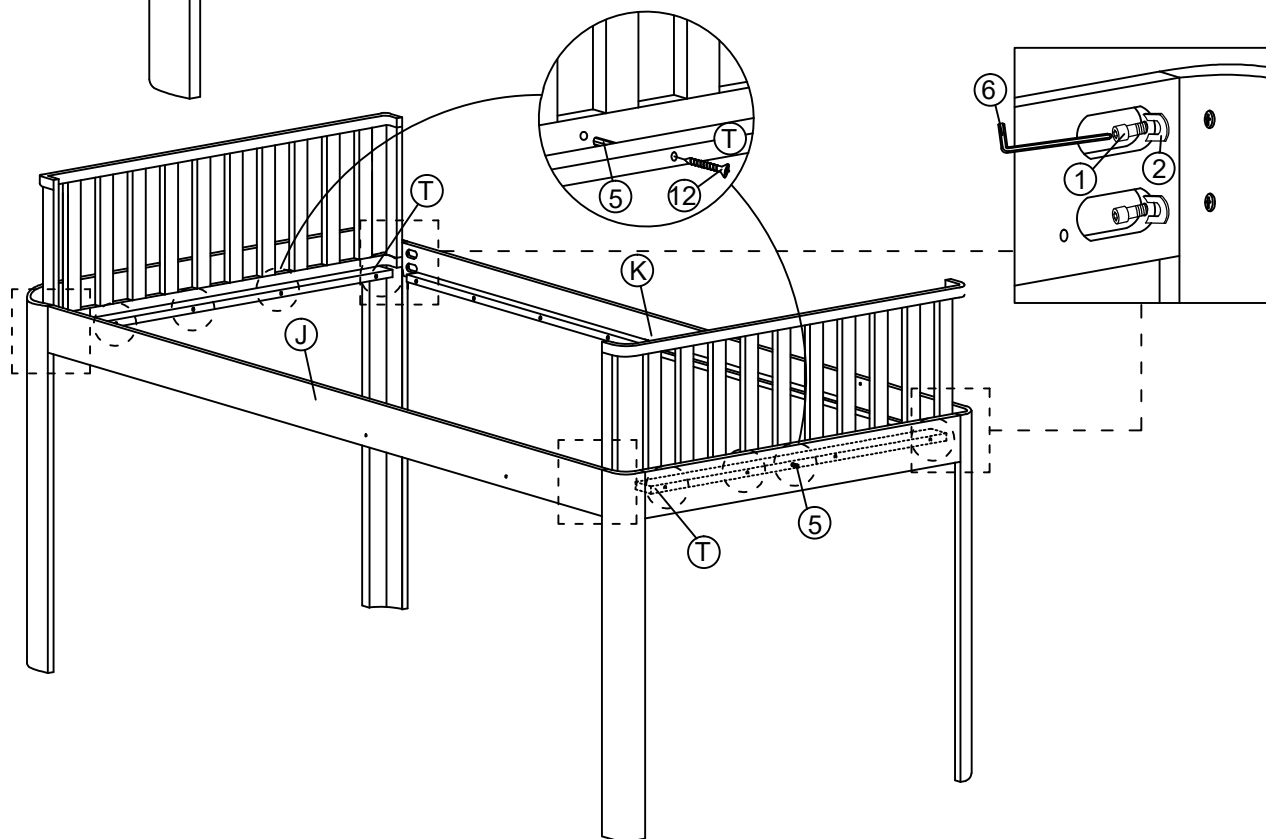

10.

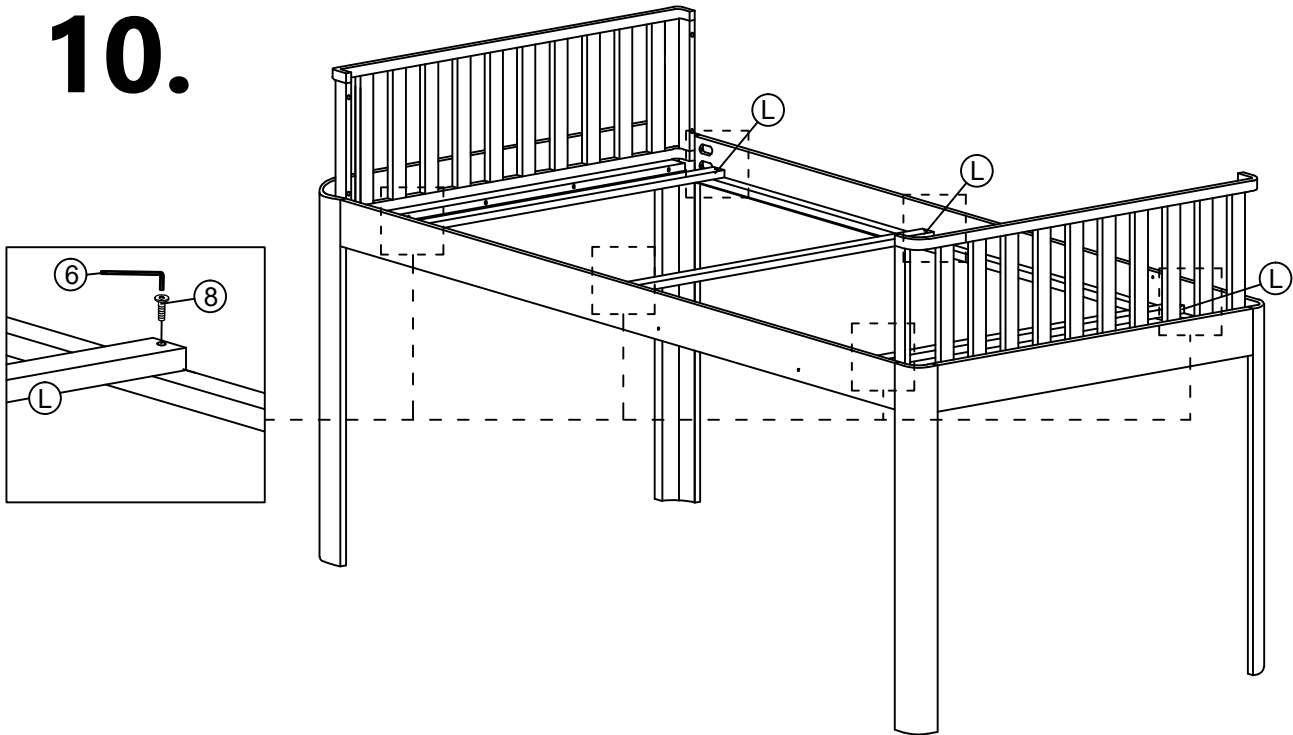

11.

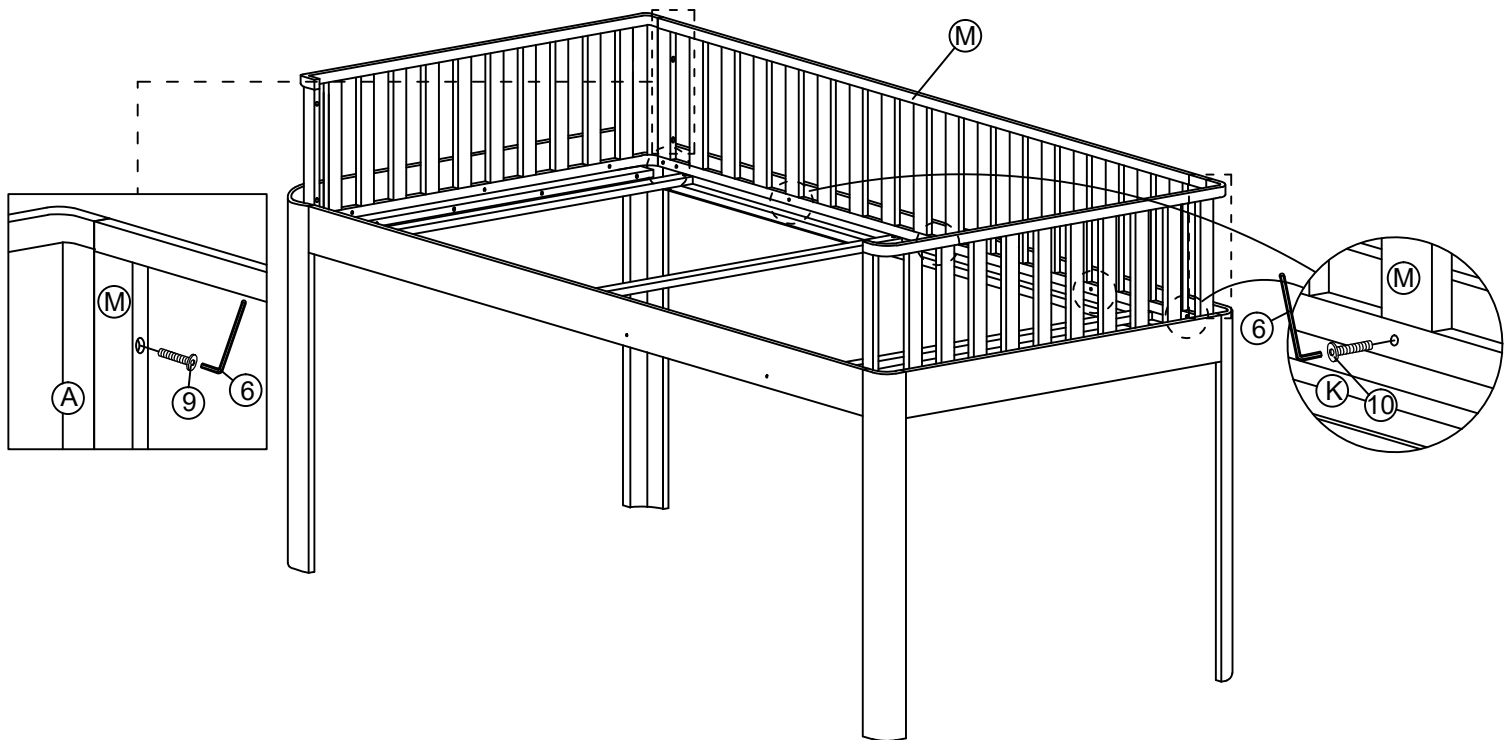

12.

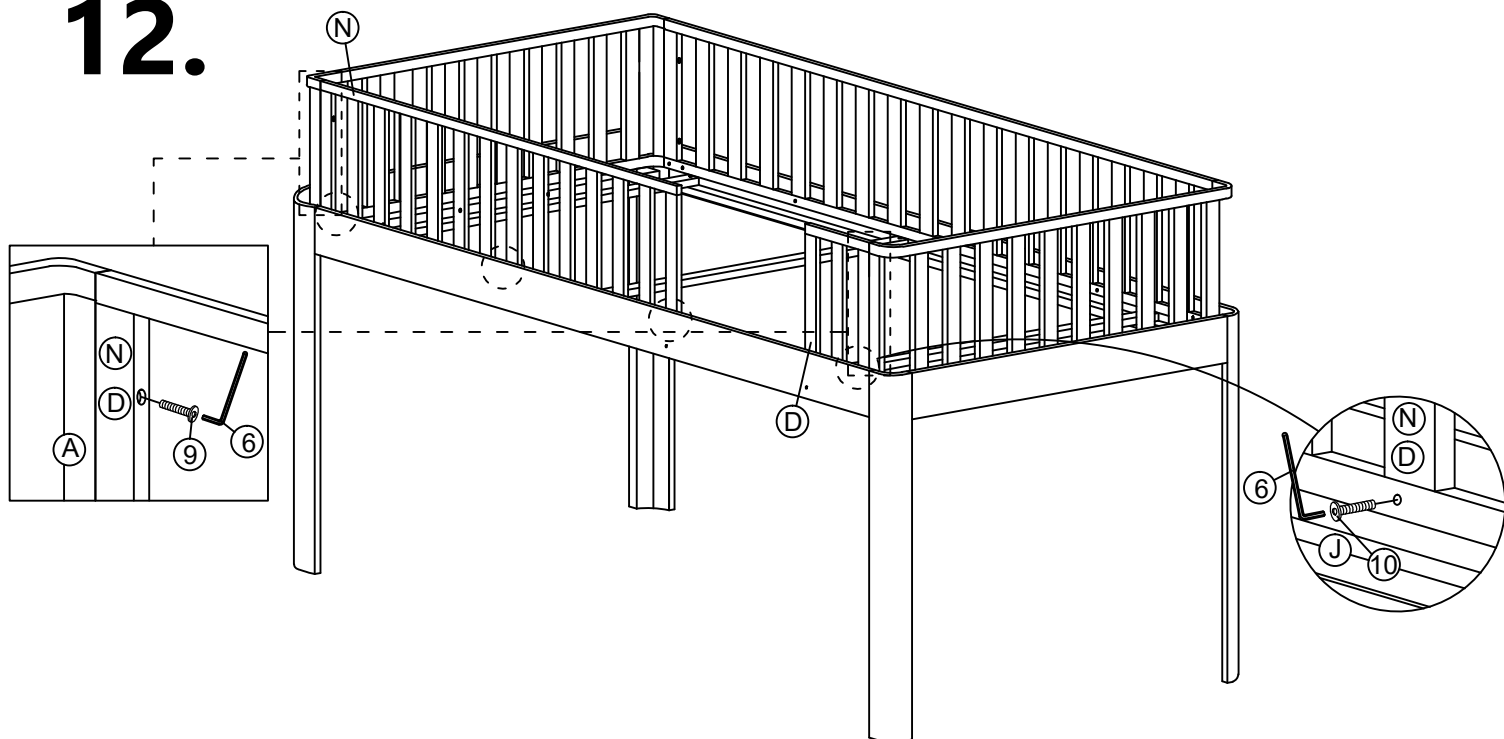

13.

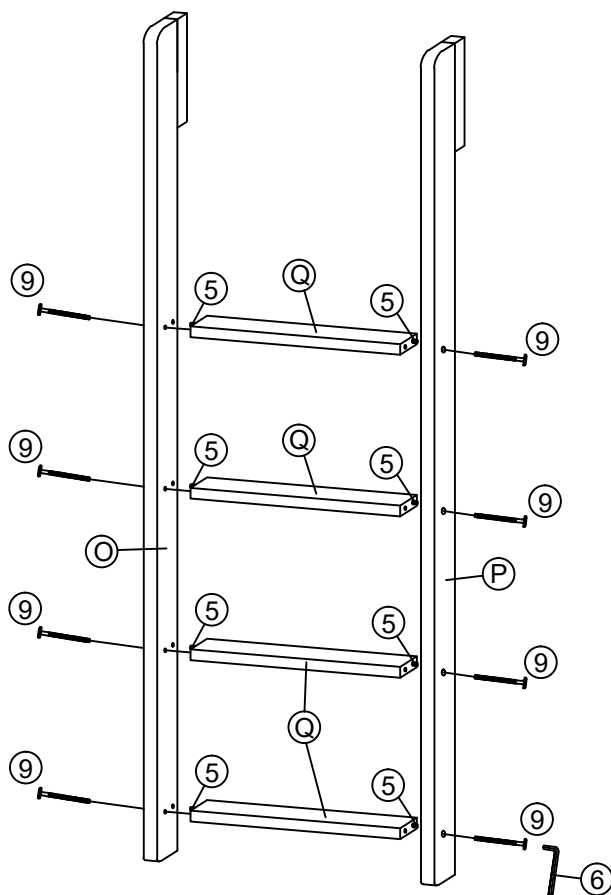

14.

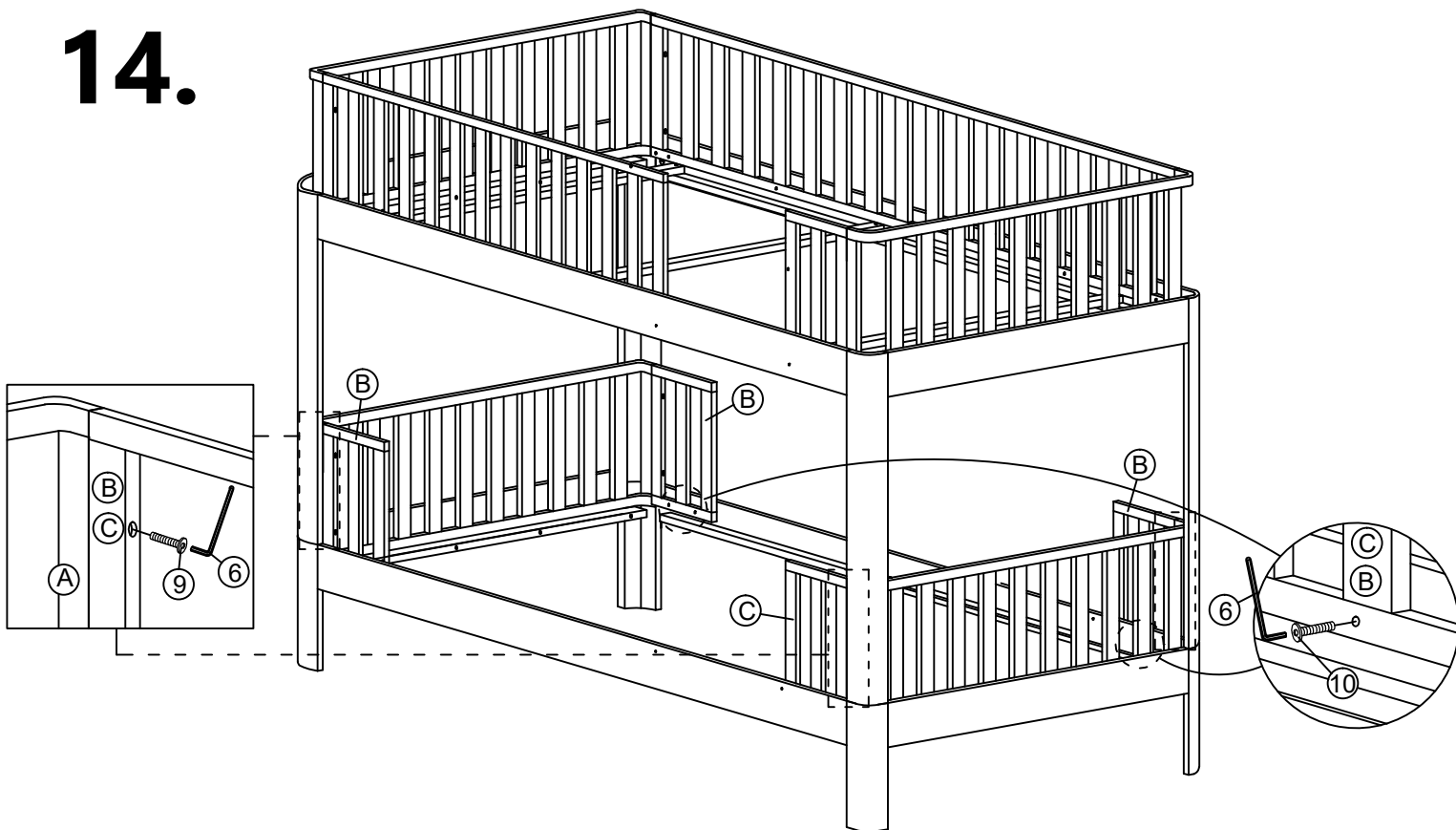

15.

*Bunk Bed connection hole

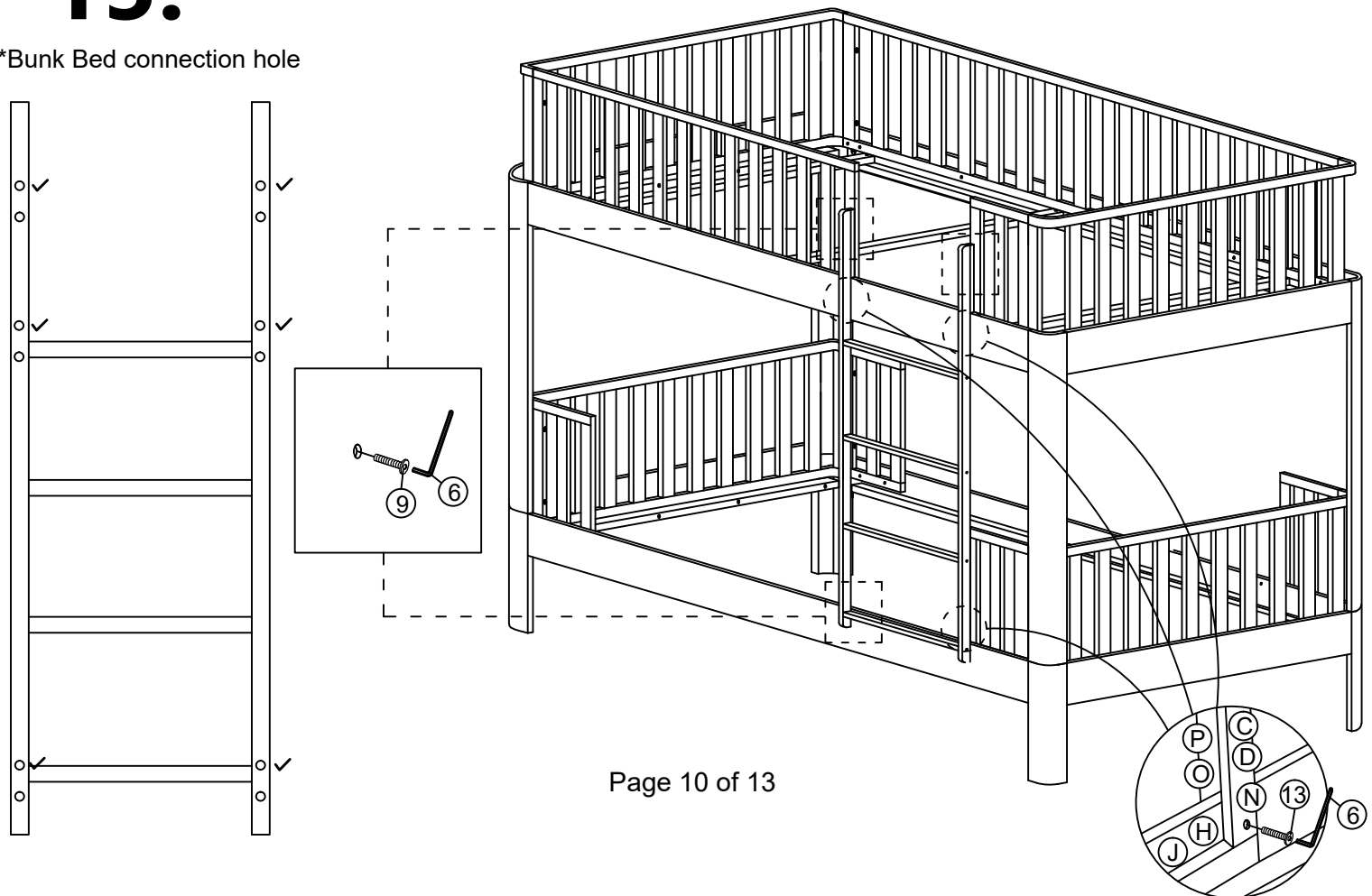

16.

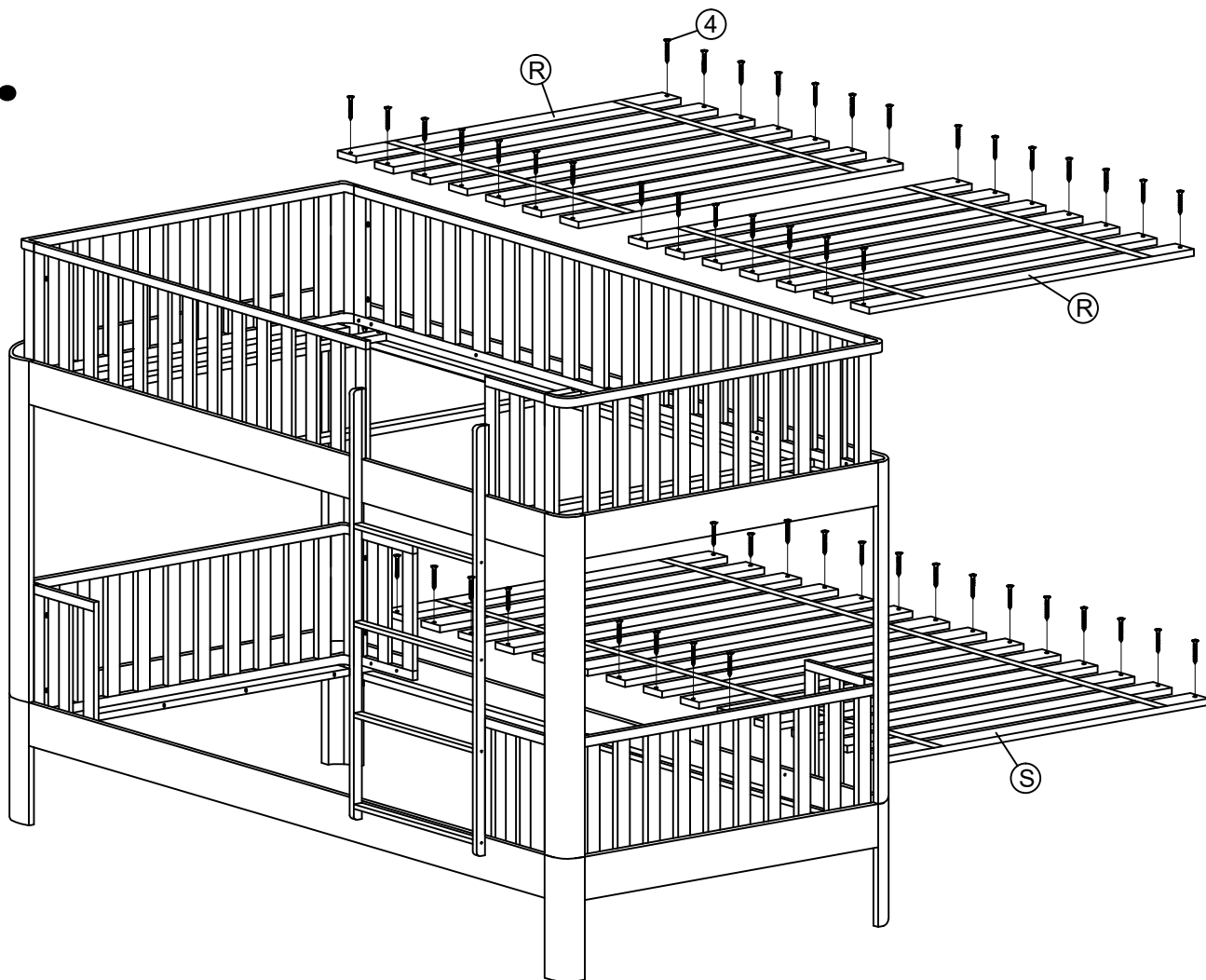

OPTION 2

Assembly Instructions

B2C FURNITURE

14.

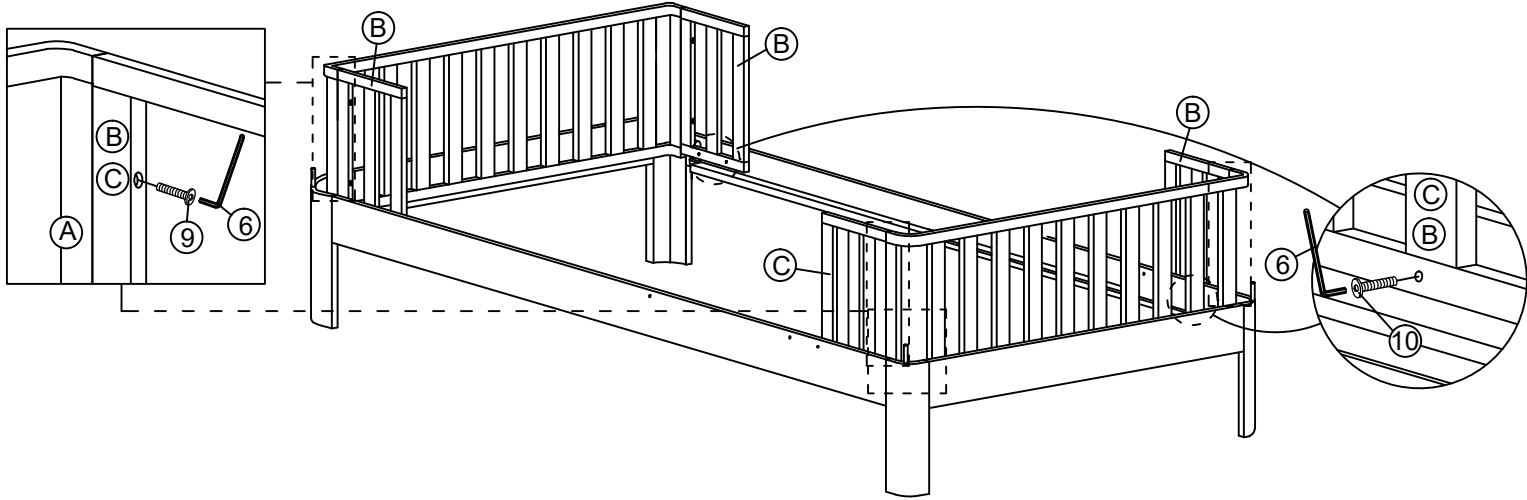

15.

*Bunk Bed connection hole

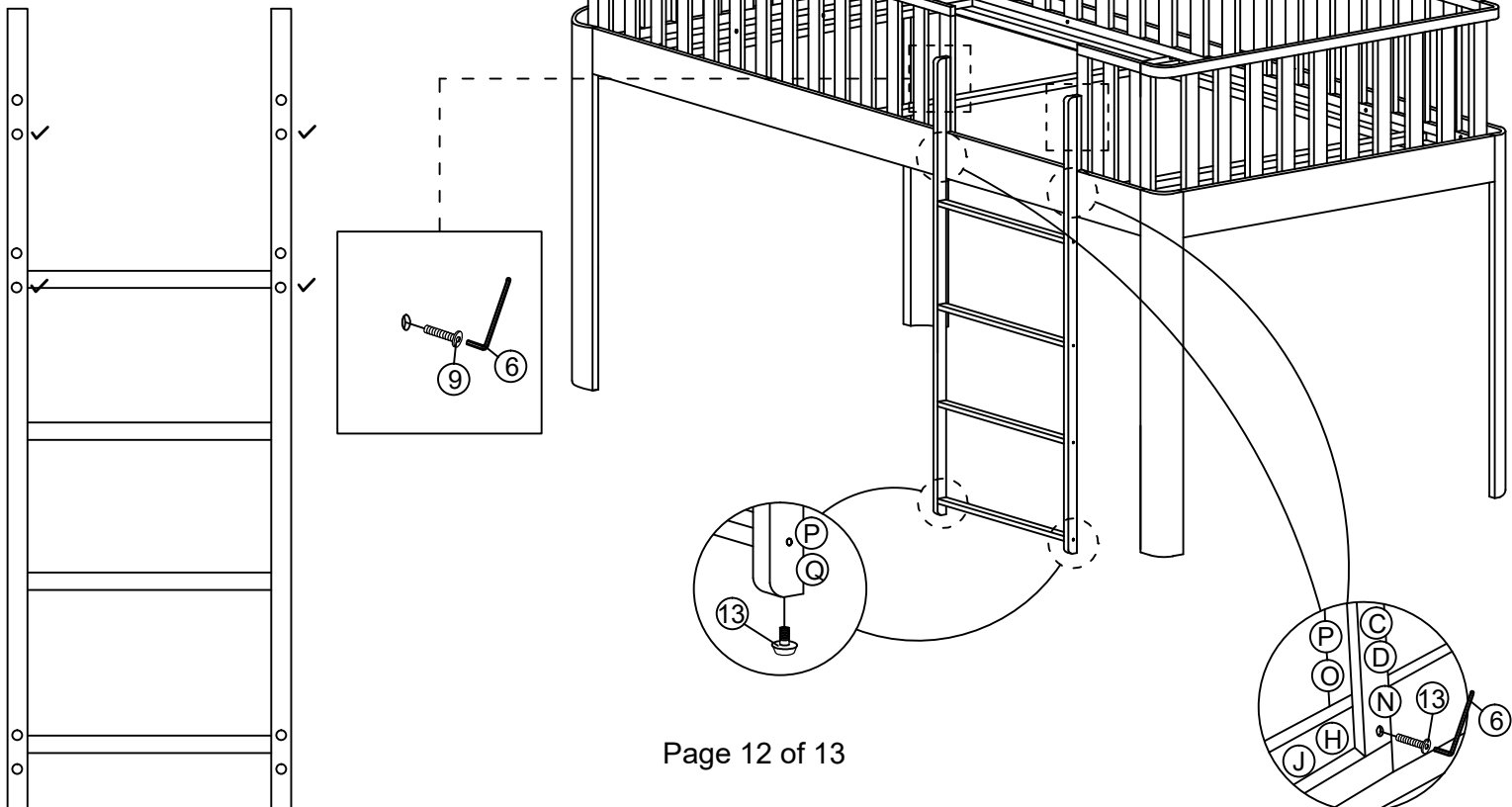

OPTION 2

Assembly Instructions

B2C FURNITURE

16.

