

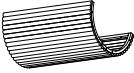

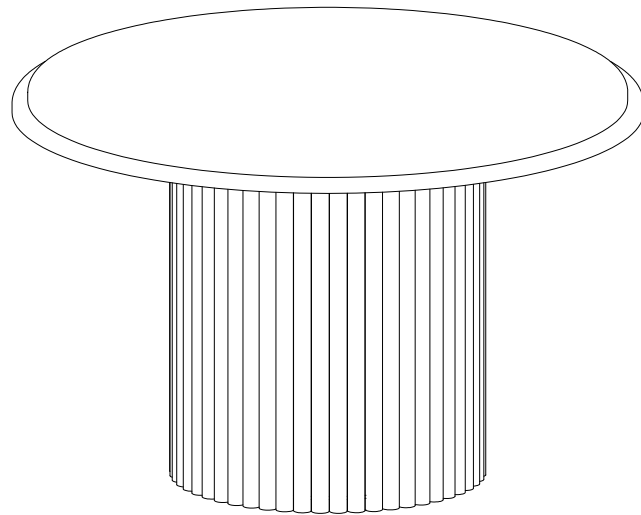







ASSEMBLY INSTRUCTIONS

MODEL :TB8087

ITEM	PART NAME	QTY
1	Table Top 	1 PC
2	Leg 	2 PCS



ITEM	HARDWARE NAME	DESCRIPTION	QTY
A	Wood Stand M8 x 65 mm		4 PCS
B	JCBC Bolt M6 x 30 mm		2 PCS
C	Spanner		1 PC
D	Flat Washer M6x13		2 PCS
E	Wood Dowel M10x30		4 PCS
F	ALLEN KEY M4 (Long)		1 PC
G	Adjuster 15mm		6 PCS
H	Hex Nut M8		4 PCS
I	Flat Washer M8		4 PCS
J	Spring Washer M8		4 PCS

STEP 1

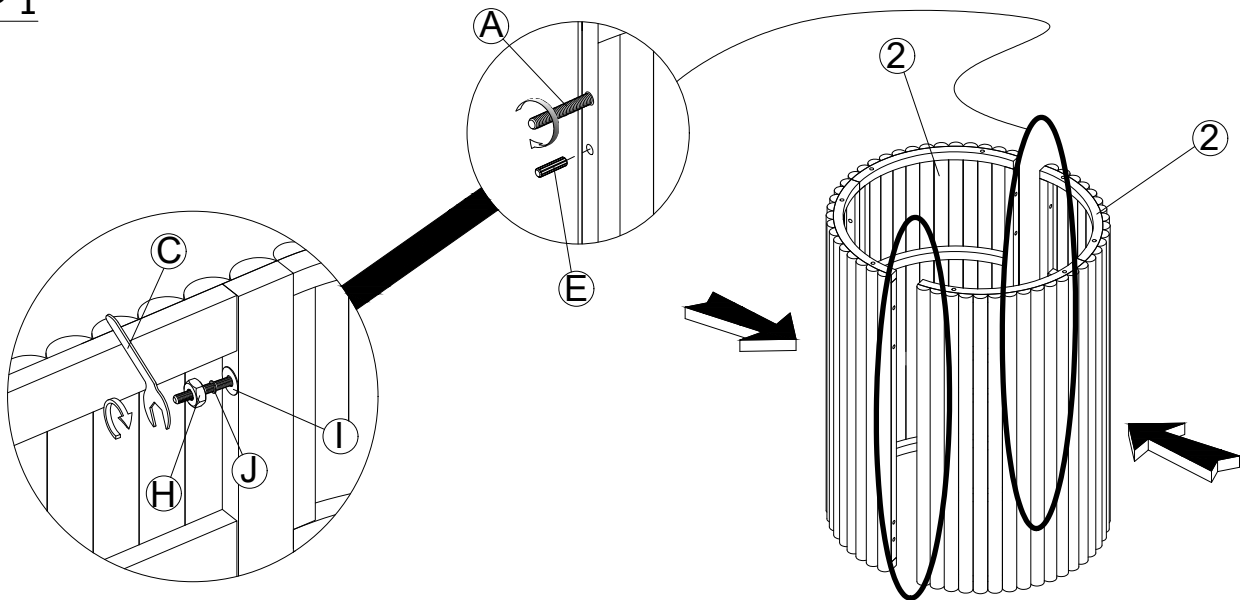

STEP 2

