

Assembles into 1 of 6 Configuration sizes

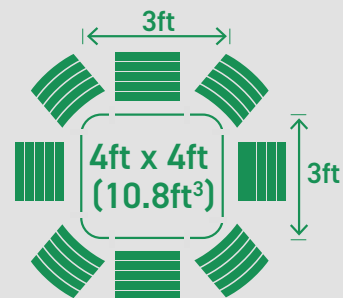

**Birdies**<sup>TM</sup>  
Garden Products

## Small 6 in 1 Short Garden Bed Assembly Instructions

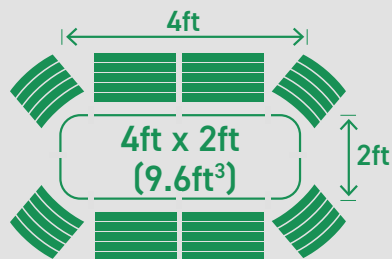
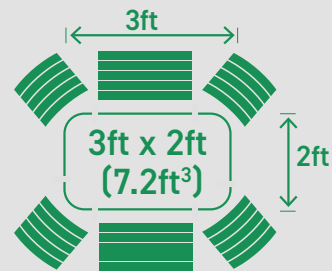
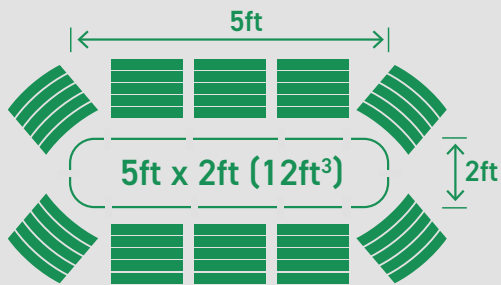
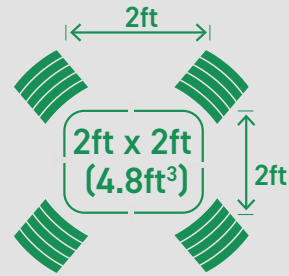
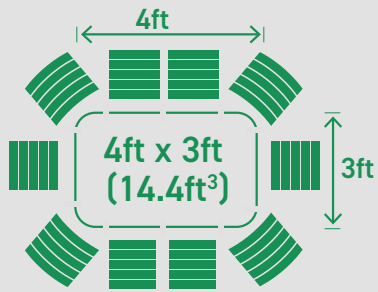

## Small Short Garden Bed Assembly Instructions

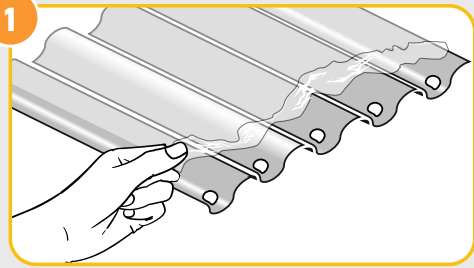

Peel protective plastic 1 inch past the punched holes. Remove remaining plastic once fully assembled.

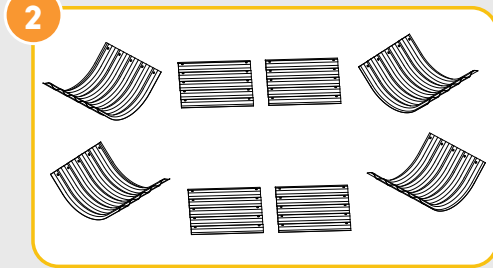

Select a size from 1 of the 6 configurations and lay panels out.

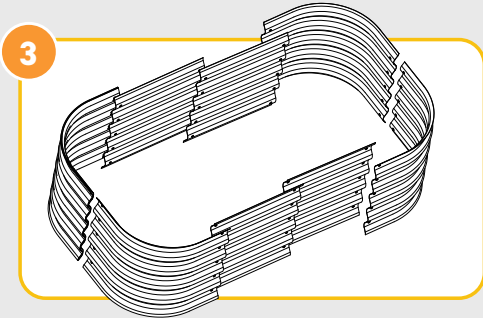

Assemble all side panels first and then attach to the corner sections. Ensure that you attach the corners on the outside of the straight sheets.

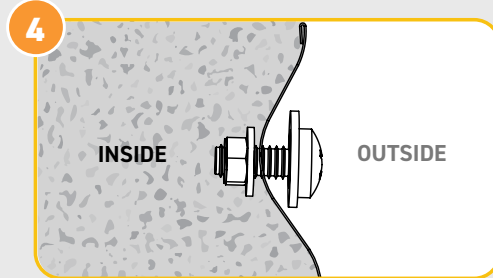

Attach all nuts loosely & then tighten using a screwdriver /cordless drill assists with this process. Failure to tighten each nut and bolt to its maximum may cause failure.

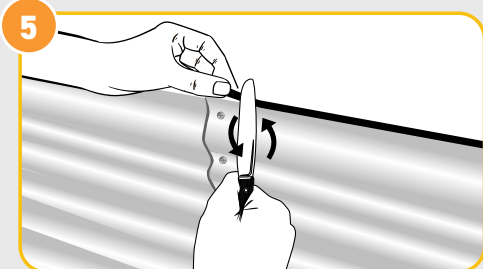

Remove the remaining protective plastic. Starting on a straight length of steel, push the safety edge over the rolled steel edge. Where the steel panels join using a butter knife to pry open will assist in attaching. **IMPORTANT:** Ensure the safety edge starts and finishes on a straight section of steel, preventing detachment.



## Individual Components

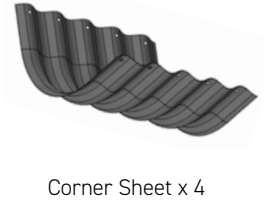
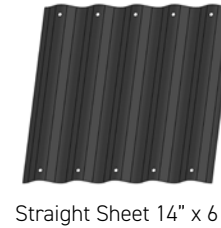
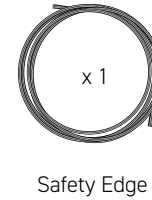

### IMPORTANT PLEASE READ FIRST:

- Before assembly and whilst unpacking please be aware that corners are sharp and could cause injury. It is advisable to wear protective gloves when handling these items, sensible shoes are also recommended. Until the clip on safety edge is fitted all necessary precautions need to be taken to avoid injury.
- Attach all nuts and bolts loosely and then use a cordless drill to tighten. Failure to tighten each nut and bolt to its maximum may result in failure.
- When assembling the wire brace it is advised to wear gloves to prevent injury.
- It is recommended placing the bottom edge of the raised bed on a 1 inch layer of gravel/stone or free draining sand. This allows for excellent drainage and also protects the bottom edge of the steel.
- If filling the beds mechanically fill the initial 1/3 of the bed slowly. When filling do not climb into the bed as this puts unnecessary pressure onto the bed.
- When filling the bed avoid dumping onto the wire bracing.
- Birdies beds are designed to handle the weight of organic based soils from landscape suppliers only.
- It is suitable to use the Hugelkultur method in the Birdies beds, See Epic Gardening and Self Sufficient Me on You tube.

