

HARMONIX

EN

SonaVue HKA Series



Product Manual

HKA01-BLK

HKA02-BLK

HKA03-BLK 1.0d

HKA03-BLK 1.5d

HKA03-BLK 2.0d

Product Specification

Product Name:

Lenses:
Color:
Filter:
Sunglasses UV protection:

SonaVue HKA Series

Photochromatic Lenses
Clear through Gray
Blue Light
Cat 2

Frame color:

Gloss Black Acetate

Version:

1.0

Bluetooth Version:

5.4

Transmission Distance:

≥ 12m

Glasses Battery Capacity:

110 mAh x 2

Usage Time:

+/- 11 hrs Streaming or +/- 9 hrs calls

Glasses Charging Time:

1.5 hrs

Water Resistance:

IP 54

Environmental Noise Cancellation:

2 Beamforming Microphones with advanced ENC for calls

Input:

5V 1A

Recharge Connection:

Magnetic connects via Type C USB Y Cable

Translation App:

AI Cool / AIP

App Requirements:

iOS 13 or Android 14.0 onwards

Case:

Fold out / Fold Flat Protective Case

Contents

1x Pair of Glasses
1x USB C charging Y cable
1x Instruction booklet
1x Cleaning Cloth
1x User Guide

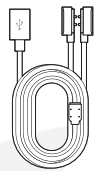

Y Shaped USB Cable



User Manual



1x Pair of Glasses

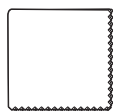

1x Cleaning Cloth

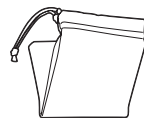

1x Case

INTRODUCTION

Congratulations on choosing a pair of SonaVue HKA Audio Glasses. The following guide offers insights into how to get the best out of the glasses.

Product Introduction

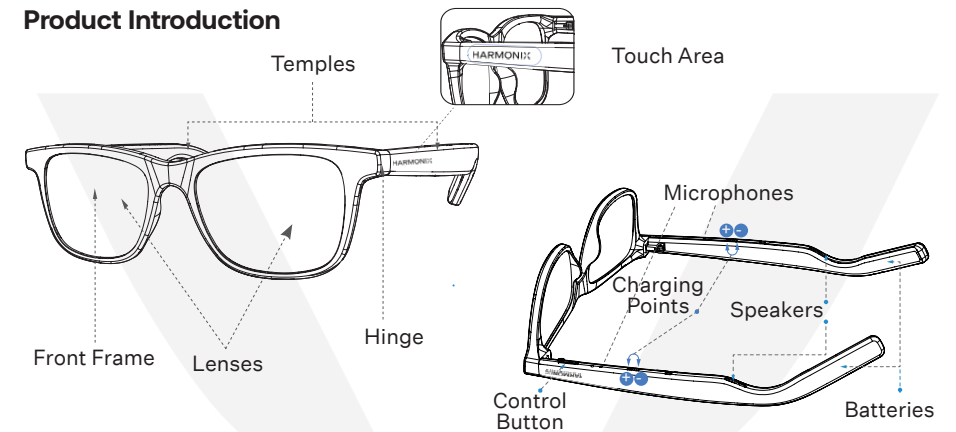

Charging and Power Levels

A third party Type C male charging cable is required to charge the glasses. These are now shipped as standard with cellphones or most consumer electronics. Connect the magnetic charging cables as below. The indicator light shows red while charging and turns off when fully charged.

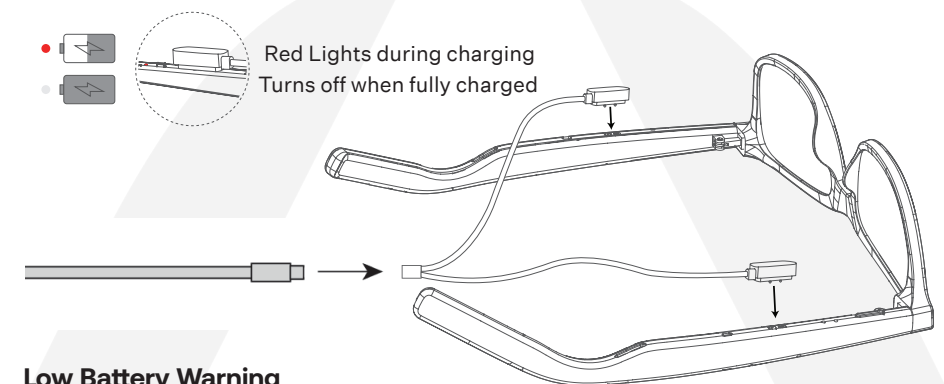

Low Battery Warning

The glasses will announce "Battery Low" when they need recharging. The glasses will turn off on the 3rd warning announcement and require full charging.

AUTO POWER ON/OFF

The glasses are fitted with a 3 array wear detector on each side for auto turn on and turn off. Make sure the glasses are fitted normally and not outside the ear.

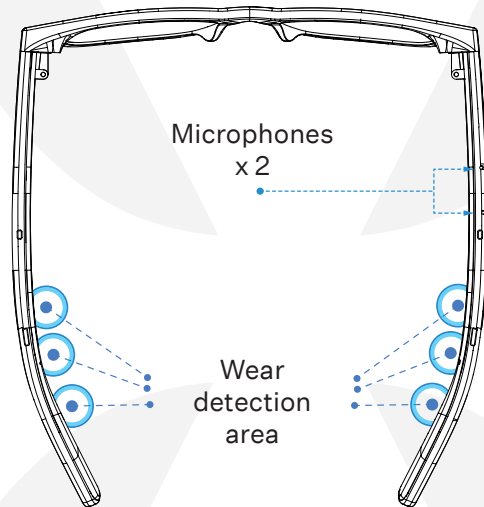
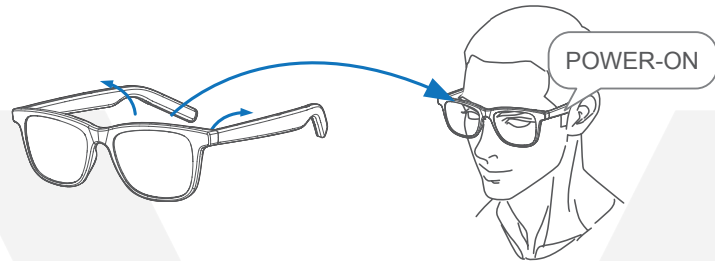

Auto Turn on after charging

The glasses will auto shutdown during charging but automatically turn on when the cables are removed.

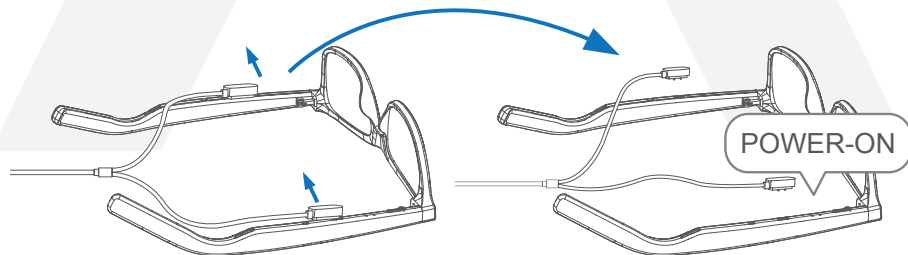

HARMONIX

harmonix.is
harmonixhearing.com

FIRST TIME PAIRING

Turn on the AI glasses and keep close to the smart device or computer.

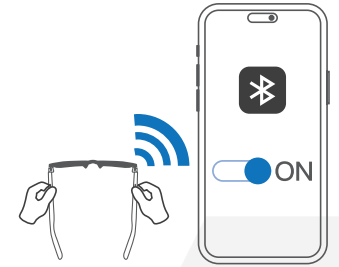

Open the settings on your device, turn on the bluetooth switch in the control centre.



Search and click on the SonaVueHKA product details, you'll hear 'connected' once successful.



If pairing with another device, you should disconnect (not forget) the device from the device currently paired with. Alternatively turn off the Bluetooth on the current device.

harmonix.is
harmonixhearing.com

HARMONIX

PHONE CALLS

Answer Calls

Click on the control button under the right temple.

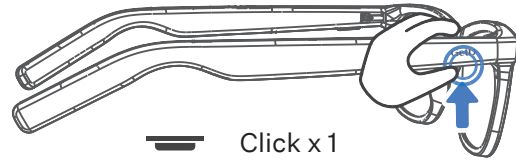

Click x 1

Hang Up Calls

Double click either button under the temple

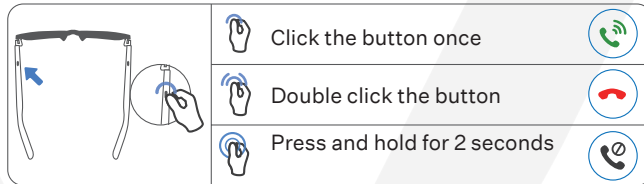

Reject Calls

Press and hold the control button under the temple for 2 seconds.

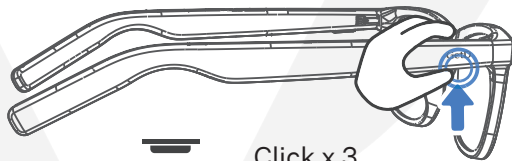

Click x 3

TAKING PICTURES WITH CAMERA or SELFIE

Click the control button three times.

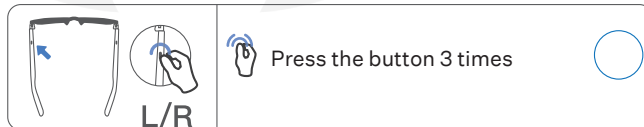

VOICE ASSISTANT

Press and hold the control button under the right temple for 2 seconds to activate the voice assistant. (cannot be used when the glasses are taking phone calls)

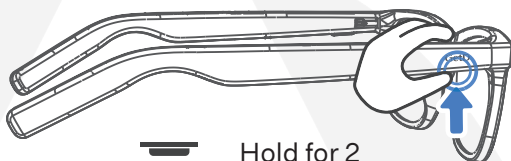

Hold for 2 Seconds



VOLUME CONTROL

Volume UP

Quickly swipe forward on the left temple touchpad.

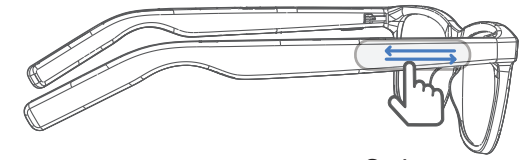

Swipe

Volume DOWN

Quickly swipe backwards on the left temple touchpad.

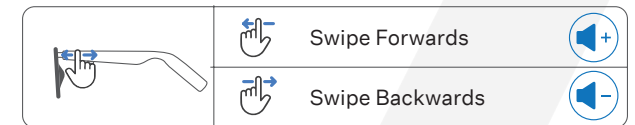

TRACK CONTROL

Next Track

Quickly swipe forward on the right temple touchpad.

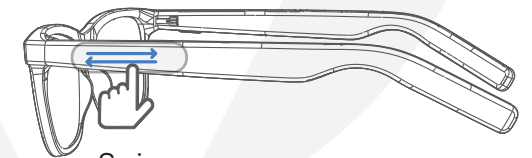

Swipe

Last Track

Quickly swipe backwards on the right temple touchpad.



PLAY/PAUSE

Press the button under the right temple to play or pause.

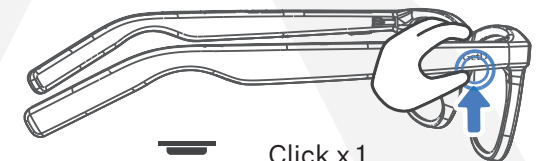

Click x 1



AI Cool/AIP App Subscription - Included

VIP Subscription Included

Thank you for purchasing from the SonaVue range of open ear glasses. Included in the product is a subscription to AI Cool/AIP translation software.

Download the APP from the link and simply open and pair via your Bluetooth settings if the device is not immediately found.

Register via email

In order to use the software, an email account is required. A verification code will be sent to the email address, please add this quickly to ensure activation. The headphones are bound by the model number and then device MAC address.

Translation services are accessed through the “Simultaneous Interpretation” button.

(note that if the Bluetooth name is changed in settings the image of your glasses may disappear to a default)

AI Cool requires an active data service (5G preferred) or Wi-Fi connection to translate.

Simultaneous Translation

Simultaneous Translation uses AI technology it pulls from the cloud. There is a slight delay depending on the performance of your device and the connection speed. Allow the device and buds to connect and start translation before opening into dialogue.

Pressing on each side will bring up the language choices.

Press on the green microphone button to start the listening and translation service.

Press the red button to stop.

Choose your languages

Choose the languages you wish to translate to and from in the header and then chose how you want the translation to output. There are 3 choices.

Pressing on the speaker button on the bottom of the screen to change translation type.

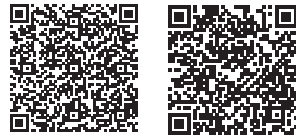

AIP Google Play AI Cool iOS

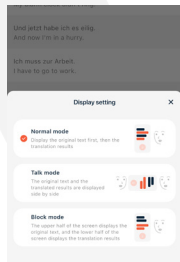
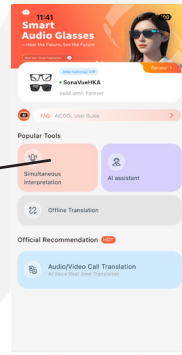

harmonix.is
harmonixhearing.com

Storage and Maintenance

- This product should be stored in a cool and dry place. Operating temperature between 0~45° C.
- Keep the product away from heat sources, combustible gases, and other cleaning/corrosive liquids. Avoid prolonged sun exposure and use/placement in any high-temperature location.
- Stop using this product immediately if any parts are damaged or produce smoke, heat, or a burning smell.
- The speaker part of this product is not waterproof but is designed to be used in normal operating conditions. It is not specifically designed for contact sports where it may be impacted, get wet or immersed in water.
- The charging cable of this product is not waterproof. Do not expose the charging case to any liquids.
- Clean the earbuds with a soft dry cloth.
- After prolonged storage, recharge before use.

Note

Design and specifications are subject to change without prior notice. For the latest company and product information, please visit www.harmonix.is

Hearing Damage

Listening to audio at excessive volumes may distort the sound and increase the risk of hearing damage and loss.

FCC

FCC ID's: XXXXXXXXXXXXXXXXXXXXX

FCC Caution

Any changes or modifications not expressly approved by the party responsible for compliance could void the user's authority to operate the equipment. This device complies with Part 15 of the FCC Rules.

Operation is subject to the following two conditions:

- (1) this device may not cause harmful interference, and
- (2) this device must accept any interference received, including interference that may cause undesired operation.

FCC Statement

This equipment has been tested and found to comply with the limits for a Class B digital device, pursuant to part 15 of the FCC Rules. These limits are designed to provide reasonable protection against harmful interference in a residential installation. This equipment generates, uses and can radiate radio frequency energy and, if not installed and used in accordance with the instructions, may cause harmful interference to radio communications. However, there is no guarantee that interference will not occur in a particular installation. If this equipment does cause harmful interference to radio or television reception, which can be determined by turning the equipment off and on, the user is encouraged to try to correct the interference by one or more of the following measures:

- Reorient or relocate the receiving antenna.
- Increase the separation between the equipment and receiver.
- Connect the equipment into an outlet on a circuit different from that to which the receiver is connected.
- Consult the dealer or an experienced radio/TV technician for help.

FCC Statement (cont)

This equipment complies with FCC radiation exposure limits set forth for an uncontrolled environment. End user must follow the specific operating instructions for satisfying RF exposure compliance. This transmitter must not be co-located or operating in conjunction with any other antenna or transmitter. The portable device is designed to meet the requirements for exposure to radio waves established by the Federal Communications Commission (USA). These requirements set a SAR limit of 1.6 W/kg averaged over one gram of tissue.

Responsible party (contact for FCC matters only): Harmonix Technologies Inc., 200 Crandon Blvd., Key Biscayne, FL 33149.

CE Declaration of Conformity

Harmonix ehf. hereby declares that this product is in compliance with the essential requirements and other relevant provisions of Directive 2014/53/EU and all other applicable EU Directive requirements. The complete declaration of conformity can be found at: <https://harmonix.is/pages/doc>. Harmonix's EU representative is Harmonix ehf. Reykjavíkurvegi 64, 220 Hafnarfjörður, Iceland.

Frequency Range: 2400-2483.5MHz
Max. Transmit Power: 10 dBm(EIRP)

Directive 2014/53/EU radiation exposure statement:

This equipment complies with Directive 2014/53/EU radiation exposure limits set forth for an uncontrolled environment. End user must follow the specific operating instructions for satisfying RF exposure compliance. This transmitter must not be co-located or operating in conjunction with any other antenna or transmitter.

The portable device is designed to meet the requirements for exposure to radio waves established by European Union market. These requirements set a SAR limit of 2W/kg averaged over ten grams of tissue.

WEEE Declaration of Conformity

This WEEE logo means that this product must not be discarded as household waste, and should be delivered to an appropriate collection facility for recycling. Proper disposal and recycling helps protect natural resources, human health and the environment. For more information on disposal and recycling of this product, contact your local municipality, disposal service, or the shop where you bought this product.

Battery CAUTION

- Replacement of a battery with an incorrect type that can defeat a safeguard.
 - Disposal of a battery into fire or a hot oven, or mechanically crushing or cutting of a battery, that can result in an explosion.
 - Leaving a battery in an extremely high temperature surrounding environment that can result in an explosion or the leakage of flammable liquid or gas.
 - A battery subjected to extremely low air pressure that may result in an explosion or the leakage of flammable liquid or gas.
 - Do not use the battery if it is noticeably expanded.
- Charging
- Ensure the earbuds are dry before putting them into the charging case and keep the charging port dry before charging.
 - Only use power adapters approved by relevant authorities and in compliance with local regulatory requirements (e.g., UL, CSA, VDE, CCC).

Dangerous Driving

· Note that using this product while driving or cycling may violate regulations in some countries or regions. Verify and comply with traffic laws and regulations in your area and consult with local regulators.

Skin Irritation

to a specific environment or long-term contact with soap, sweat, UV protection products, lotions, and other potentially irritating substances to the skin may cause allergic reactions.

- To reduce the risk of skin irritation, do not wear the product on any body parts with skin injuries.
- Stop wearing the product immediately and consult your physician if your skin develops redness, swelling, itching, or any other irritating reaction.

Electromagnetic Interference

- Do not use this product in places where wireless devices are prohibited (such as in airports and local medical facilities, etc.), as it may interfere with other electronic devices or cause other hazards.
- Some electronic devices may fail due to radio interference from this product (e.g., some automotive electronic equipment). Please contact the manufacturer of such electronic devices for more information.
- Radio waves generated by this product may affect the regular operation of some medical devices, such as pacemakers, defibrillators, cochlear implants, hearing aids, etc. If you use any of these medical devices, consult your physician and medical device manufacturer about restrictions service, or the shop where you bought this product.

Choking Hazard

- Keep the glasses and charging case away from children and pets.

In case of accidental ingestion, seek immediate medical assistance.

Manufacturer's Warrant Statement:

Harmonix provides a limited 12-month international warranty service (including USA) and 24-month warranty service for this product for products bought in the EU. For information on current warranties, visit our website: www.harmonix.is or contact your seller. Ensure compliance with all local laws and regulations before using this product.

**Harmonix
Customer Service
Link**



Harmonix ehf.
Reykjavíkurvegur 64,
220 Hafnarfjörður
Iceland

Harmonix Technologies LLC
200 Crandon Blvd.,
Key Biscayne,
FL 33149,
USA

HARMONIX

harmonix.is
harmonixhearing.com

harmonix.is
harmonixhearing.com

HARMONIX